

GBC FuturoPunch Pro

Service Manual



CAUTION

Certain components in the GBC FuturoPunch Pro are susceptible to damage from electrostatic discharge. Observe all ESD procedures to avoid component damage.

Part Number: 7724991
Revision Number: A1
Issue Date: November 2023

Table of Contents

NOTICE

All service documentation is supplied to external customers for informational purposes only. Service documentation is intended for use by certified, product trained service personnel only. GBC does not warrant or represent that such documentation is complete. GBC does not warrant or represent that it will notify or provide to such customer any future changes to this documentation. Service by the customer of the equipment, or modules, components, or parts of such equipment may void any otherwise applicable GBC warranties. If customer services such equipment, modules, components, or parts thereof, Customer releases GBC from any and all liability for actions by the Customer, and Customer agrees to indemnify, defend, and hold GBC harmless from any third party claims which arise directly or indirectly from such service.

Changes are periodically made to this document. Changes, technical inaccuracies, and typographic errors will be corrected in subsequent editions.

Please contact Xerox Digital Content and Language Services with any comments or suggestions regarding the content within this document.

Copyright Notice

GBC
ACCO Brands Inc.
Four Corporate Drive
Lake Zurich, IL 60047.
USA

© Copyright 2014 by ACCO Brands Inc. All Rights reserved.

No part of this document may be photocopied or reproduced by any means, or translated to another language without prior written consent of GBC

All brand names, trademarks and registered trademarks are the property of their respective owners. Information contained within this document is subject to change without notice.

GBC products mentioned in this publication are registered trademarks of the ACCO Brands Corporation.

Title	Page
Service Call Procedures	
Introduction	iii
1. Service Call Procedures	1-1
2. Status Indicator RAPs	2-1
3. Punch Quality	3-1
4. Repairs/Adjustments	4-1
5. Parts List	5-1
6. General Procedures	6-1
7. Wiring Data	7-1

Section Contents

Title	Page
Table of Contents.....	ii
Introduction	iii
Organization	iv
How to Use This Documentation	iv
Safety Messages in other Languages	vi
Other Information	xvi
The Use of Caution, Warning, and Note statements	xvi
Safety Devices	xvi
Door Interlock	xvi
Operational Safety.....	xvii
Warnings and Cautions	xvii
Acronyms.....	xviii
Reference Symbology	xviii

Organization

This documentation is divided into eight sections. In addition to the Introduction, this documentation contains the following sections.

Section 1	Service Call Procedures
Section 2	Status Indicator RAPs
Section 3	Punch Quality
Section 4	Repairs/Adjustments
Section 5	Parts List
Section 6	General Procedures
Section 7	Wiring Data

How to Use This Documentation

Introduction

This section provides the Service Representative with information pertaining to the organization and use of this service documentation.

Section 1: Service Call Procedures (SCP)

This section is used by the Service Representative as a structured process for determining the type and sequence of actions that are performed during a service call. The Service Call Procedures section is designed to assist in the effective recognition of machine symptoms and problems, as well as to provide instructions for the maintenance and corrective actions that are required to return the machine to the full operating condition

Section 1 of this service documentation is the entry level for all service calls. The Service Representative should begin each service call with the Initial Action Procedure found in Section 1.

The Service Call Procedures section is composed of five integral elements: Initial Action, System Checks, Every Call Activities, Scheduled Maintenance, and Final Action.

The maintenance and diagnostic activities in this section may direct the Service Representative to perform additional service activities found elsewhere in the documentation, such as RAPs, Removal and Replacement Procedures, and Adjustment Procedures.

Section 2: Status Indicator RAPs

Section 2 of this documentation contains the Repair Analysis Procedures (RAPs) necessary to repair all faults other than the image quality faults. The Service Representative will be referred to this section from some other section of this documentation during the service call. When a machine defect or fault has been resolved by using a RAP, the Service Representative should immediately return to the point in the service call from which Section 2 was entered. There are two types of RAPs found in Section 2. The first type is a RAP that is associated with the display of an error message in the RAP title. The second type is the Troubleshooting RAP. Troubleshooting RAPs are diagnostic procedures that are designed to address symptoms or problems that are not identified by, or associated with, a displayed status or fault code.

Section 3: Punch Quality

This section contains the Punch Quality Defect Entry Rap used to diagnose punch quality defect problems.

Section 4: Repairs and Adjustment Procedures

This section contains all repair and adjustment procedures for the machine. Repairs (REPs) and adjustments (ADJs) are identified by the use of a standard chain prefix number.

Section 5: Parts List

This section contains a list of spare parts for the machine. All parts list page reference numbers begin with the letters "PL", followed by a prefix number, a decimal point, and a sequential number used within the subsystem.

Section 6: General Procedures

This section contains procedures and information of a general nature that apply to the machine. This section is divided into two basic parts: General Procedures and General Information.

Section 7: Wiring Data

This section contains support information to assist in the electrical diagnosis of machine problems and is a central location for electrical wiring diagrams. This section is used in conjunction with other diagnostic or maintenance procedures that are contained in other sections of the service documentation.

Block Schematic Diagrams (BSD's)

Block Schematic Diagrams (BSDs) are used as an aid to troubleshoot electrical problems.

Wirenet Diagrams

This section contains wirenet diagrams used to troubleshoot AC power, DC power, AC neutral, and DC return distributions; and are sometimes used to support RAPs. Wirenets are useful when it is necessary to know the termination components in a source circuit, such as DC power.

Safety Messages in other Languages

GB	<p>WARNING</p> <p>Do not perform repair activities with the power on or electrical power supplied to the machine. Some machine components contain dangerous electrical voltages that can result in electrical shock and possible serious injury.</p>
F	<p>AVERTISSEMENT</p> <p>Ne pas effectuer de réparations avec la machine sous tension ou branchée. Certains composants de la machine peuvent contenir des tensions électriques dangereuses et provoquer une électrocution ou des blessures graves.</p>
E	<p>ADVERTENCIA</p> <p>No realice actividades de reparación con la máquina encendida o conectada a la energía eléctrica. Algunos componentes de la máquina contienen tensiones eléctricas peligrosas que pueden provocar una descarga eléctrica y posibles lesiones graves.</p>
I	<p>AVVERTENZA</p> <p>Non eseguire interventi di riparazione quando la macchina è accesa o viene erogata energia elettrica ad essa. Alcuni componenti della macchina hanno tensioni elettriche pericolose che possono provocare scosse elettriche ed eventuali lesioni serie.</p>
D	<p>WARNUNG</p> <p>Keine Reparaturarbeiten durchführen, wenn die Maschine eingeschaltet oder an die Stromversorgung angeschlossen ist. Einige Maschinenkomponenten führen gefährliche elektrische Spannungen, die zu einem Stromschlag und möglicherweise schweren Verletzungen führen können.</p>
NL	<p>WAARSCHUWING</p> <p>Voer geen herstellingen uit aan het toestel als het aan staat of als de stroom ingeschakeld is. Sommige onderdelen bevatten gevaarlijke elektrische spanning die kan leiden tot elektrische schokken en ernstige letsels.</p>
PT	<p>AVISO</p> <p>Não execute atividades de reparação com a fonte de energia ligada na máquina. Alguns componentes da máquina contêm tensões elétricas perigosas que podem causar choque elétrico e ferimentos graves.</p>
RU	<p>ВНИМАНИЕ</p> <p>Выполнение работ по техническому обслуживанию при включенном устройстве или подключенном источнике</p>

	<p>питания не допускается. Отдельные узлы устройства находятся под опасным напряжением, что может привести к поражению электрическим током и серьезным травмам.</p>
CHI	<p>警告</p> <p>不得在加电或机器供电情况下执行维修活动。一些机器零部件包含危险电压，可导致电击和可能严重伤亡事故。</p>

GB	Warning: Make sure you disconnect the FuturoPunch Pro from its power source before cleaning. Failure to observe this warning could result in death or serious Injury.
F	Avertissement: Assurez-vous que le FuturoPunch Pro est débranché de son alimentation électrique avant de le nettoyer. Le non respect de cet avertissement peut provoquer la mort ou de graves blessures.
E	ADVERTENCIA: Asegúrese de desconectar la perforadora FuturoPunch Pro de la toma de alimentación antes de limpiarla. El incumplimiento de esta advertencia podría causar lesiones graves o incluso la muerte..
I	Avvertenza: Assicurarsi di aver disconnesso l'FuturoPunch Pro dall'alimentazione prima di procedere alla pulizia. La non osservanza di questo avvertimento può avere come conseguenza la morte o lesioni gravi. serie.
D	Warnung: Sicherstellen, dass der FuturoPunch Pro vor der Reinigung von seiner Stromversorgung getrennt wird. Die Nichtbeachtung dieses Warnhinweises kann zum Tod oder schweren Verletzungen führen.
NL	Waarschuwing: Trek de stekker van de FuturoPunch Pro uit voor u het toestel reinigt. Het niet naleven van deze waarschuwing kan de dood of ernstige letsels tot gevolg hebben.
PT	Aviso: Certifique-se de desligar o FuturoPunch Pro da fonte de energia. Se as instruções deste aviso não forem seguidas, poderão ocorrer mortes ou ferimentos graves.
RU	ВНИМАНИЕ: Перед началом работ по очистке необходимо убедиться в том, что устройство отключено от источника питания. Несоблюдение данного предупреждения может привести к получению серьезной травмы или летальному исходу.
CHI	警告: 确保清洁之前把FuturoPunch Pro与其电源断开。 未能遵守这一点可导致严重伤亡事故。。

GB	WARNING Moving Parts, keep hands clear of nips and the belts when the Interlock is cheater is inserted.
F	AVERTISSEMENT Pièces mobiles, éloignez les mains des contacts et des courroies lorsque la broche de verrouillage est insérée.
E	ADVERTENCIA Piezas móviles, mantenga las manos alejadas y absténgase de tocar las correas para evitar pellizcos cuando el emulador de inter-bloqueo esté insertado.
I	AVVERTENZA Parti in movimento, non toccare i morsetti e le cinghie quando il Regolatore di interblocco è inserito.
D	WARNUNG Bewegliche Teile, Hände von den Walzenspalten und Riemen fernhalten, wenn die Verriegelungsüberbrückung (Interlock Cheater) eingesetzt ist.
NL	WAARSCHUWING Bewegende delen, houd uw handen uit de buurt van de spleten en de riemen als de cheater (stukje om vergrendeling te omzeilen) van de vergrendeling geplaatst is.
PT	AVISO Mantenha as mãos distantes dos estreitamentos e das correias quando o bloqueador for introduzido nas peças móveis.
RU	ВНИМАНИЕ Движущиеся части, не прикасаться к валкам и ремням при вставленном ключе отключения блокировки.
CHI	警告 移动零件时，当插入连锁装置时，请将手远离尖锐凸起和皮带。

GB	Caution – Potential damage to the machine could result unless the specified procedures are followed.
F	Mise en garde – La machine peut subir des dégâts si les procédures indiquées ne sont pas suivies.
E	Precaución – Pueden producirse daños en la máquina a menos que se sigan los procedimientos especificados.
I	Cautela – Se non le procedure specifiche non vengono rispettate, si potrebbe verificare un eventuale danno della macchina.
D	Vorsicht – Die Maschine könnte beschädigt werden, wenn die angegebenen Verfahren nicht eingehalten werden.
NL	Voorzorgsmaatregel – Als men de vermelde procedures niet volgt kan het toestel beschadigd raken.
PT	Advertência – Se os procedimentos específicos não forem seguidos, podem ocorrer possíveis danos à máquina.
RU	Осторожно – Несоблюдение указанных процедур может привести к повреждению устройства.
CHI	当心 – 请务必遵守特定程序，避免机器出现潜在危险。

GB	WARNING Do not touch the open terminals of the power supply or any other connector with the AC power cord connected. The machine components contain dangerous electrical voltages that can result in electrical shock and possible serious injury.
F	AVERTISSEMENT Ne touchez pas les bornes ouvertes de l'alimentation électrique ni tout autre connecteur si le cordon d'alimentation en c.a. est branché. Les composants de la machine contiennent des tensions électriques dangereuses qui peuvent provoquer une électrocution ou des blessures graves.
E	ADVERTENCIA No toque los terminales de la fuente de alimentación o de cualquier otro conector cuando el cable de alimentación de CA esté conectado. Los componentes de la máquina contienen tensiones eléctricas peligrosas que pueden provocar una descarga eléctrica y posibles lesiones graves.
I	AVVERTENZA Non aprire i terminali aperti dell'alimentazione o di qualsiasi altro connettore se il cavo di alimentazione CA è connesso. I componenti della macchina dispongono di tensioni elettriche pericolose che possono provocare scosse elettriche ed eventuali lesioni gravi.
D	WARNUNG Wenn das Netzkabel angeschlossen ist, keine offenen Klemmen der Stromversorgung oder anderer Verbinder berühren. Die Maschinenkomponenten führen gefährliche elektrische Spannungen, die zu einem Stromschlag und möglicherweise schweren Verletzungen führen können.
NL	WAARSCHUWING Raak geen open terminals van de stroomtoevoer of andere connectoren aan, als de AC voedingskabel is aangesloten. De onderdelen van het toestel bevatten gevaarlijke spanning die tot elektrische schokken en ernstige letsels kan leiden.
PT	AVISO Não toque nos terminais abertos da fonte de alimentação ou qualquer outro conector com o cabo de alimentação CA conectado. Os componentes da máquina contêm tensões elétricas perigosas que podem causar choque elétrico e ferimentos graves.

RU	<p style="text-align: center;">ВНИМАНИЕ</p> <p>Не допускается прикасаться к открытым клеммам источника питания и иным элементам соединения при подключенном шнуре питания переменного тока. Отдельные узлы устройства находятся под опасным напряжением, что может привести к поражению электрическим током и серьезным травмам.</p>
CHI	<p style="text-align: center;">警告</p> <p>在连接交流电时不得接触电源开放端子或任何其他接头。 机器零部件包含危险电压，可导致电击和可能严重伤亡事故。</p>

GB	<p>CAUTION: Sensor emits High Intensity narrow angle Infrared beam (940nm). It is invisible to naked eye, avoid looking directly at the sensor when the machine is powered ON.</p>
F	<p>MISE EN GARDE: Le capteur émet un faisceau infrarouge de forte intensité et à angle de rayonnement étroit (940 nm). Il est invisible à l'œil nu ; évitez de regarder directement le capteur lorsque la machine est sous tension.</p>
E	<p>PRECAUCIÓN: El sensor emite un rayo infrarrojo angosto de alta intensidad (940 nm). Es invisible a simple vista, evite mirar directamente el sensor cuando la máquina esté encendida.</p>
I	<p>CAUTELA: Il sensore emette un raggio a infrarossi ad angolo stretto e ad alta intensità (940 nm). È invisibile a occhio nudo; evitare quindi di guardare direttamente il sensore quando la macchina è accesa.</p>
D	<p>VORSICHT: Der Sensor gibt einen schmalen Infrarotstrahl hoher Intensität ab (940 nm). Er ist mit bloßem Auge nicht sichtbar. Bei eingeschalteter Maschine nicht direkt in den Sensor schauen.</p>
NL	<p>Voorzorgsmaatregel: De sensor straalt een smalle infraroodstraal (940nm) uit met hoge intensiteit. Deze straal is niet te zien met het blote oog, kijk niet rechtstreeks naar de sensor als het toestel AAN staat.</p>
PT	<p>Advertência: O sensor emite um raio infravermelho com ângulo estreito e de alta intensidade (940nm). Como o raio é invisível a olho nu, evite olhar diretamente para o sensor quando a máquina estiver ligada.</p>
RU	<p>ОСТОРОЖНО: Сенсорный датчик излучает узкий инфракрасный луч высокой интенсивности (940 нм). Луч не виден невооруженным глазом. Необходимо избегать смотреть прямо на датчик при включенном питании устройства.</p>
CHI	<p>当心: 传感器发出高强度窄角红外光束(940nm)。 该红外光束肉眼无法看到, 在机器加电时避免直视传感器。</p>

GB	<p>The Use of Caution, Warning, and Note statements Information relative to the completion of a task in a safe or thorough manner will be supplied in the form of a Caution, a Warning, or a Note statement. These statements are found throughout the service documentation. Cautions, Warnings, and Note statements appear before the steps to which they apply. These statements should be read before continuing to the next step in a procedure.</p> <p>Caution - A Caution statement indicates an operating or maintenance procedure, practice, or condition that, if not strictly observed, could result in damage to, or destruction of, equipment. Warning - A Warning statement indicates an operating or maintenance procedure, practice, or condition that, if not strictly observed, could result in personal injury or loss of life. Note - A Note statement indicates an operating or maintenance problem, practice, or condition that is necessary to accomplish a task efficiently.</p>
F	<p>Utilisation des mises en garde, des avertissements et des remarques Des informations relatives à l'exécution d'une tâche de façon sécurisée et minutieuse sont données sous la forme de déclaration de Mise en garde, Avertissement ou Remarque. Ces déclarations se trouvent dans toute la documentation d'entretien. Les déclarations de Mise en garde, Avertissement et Remarque apparaissent avant les étapes concernées. Ces déclarations doivent être lues avant de passer à l'étape suivante d'une procédure.</p> <p>Mise en garde - Une déclaration de Mise en garde indique une procédure, pratique ou condition d'utilisation et de maintenance qui, si elle n'est pas strictement respectée, peut entraîner des dégâts ou la destruction de l'équipement. Avertissement - Une déclaration d'Avvertissement indique une procédure, pratique ou condition d'utilisation et de maintenance qui, si elle n'est pas strictement respectée, peut entraîner des blessures corporelles ou la mort. Remarque - Une déclaration de Remarque indique un problème, une pratique ou une condition de maintenance nécessaires pour exécuter une tâche efficacement.</p>
E	<p>Uso de los avisos de Precaución, Advertencia y Nota La información relativa a la realización de una tarea de una forma segura o cuidadosa se proporcionará en forma avisos de Precaución, Advertencia o Nota. Estos avisos se encuentran a través de toda la documentación de servicio.</p>

	<p>Los avisos de Precaución, Advertencia y Nota aparecen antes de los pasos a los que se aplican. Estos avisos se deben leer antes de continuar con el siguiente paso en el procedimiento. Precaución: Un aviso de Precaución indica un procedimiento operativo o de mantenimiento, una práctica o una condición que, si no se sigue estrictamente, puede producir daños o la destrucción del equipo. Advertencia: Un aviso de Advertencia indica un procedimiento operativo o de mantenimiento, una práctica o una condición que, si no se sigue estrictamente, puede producir lesiones personales o la muerte. Nota: Una Nota indica un problema operativo o de mantenimiento, una práctica o una condición que es necesaria para realizar una tarea en forma eficiente.</p>
I	<p>Uso dei messaggi di Cautela, Avvertenza e Nota Le informazioni relative al completamento del lavoro in modo sicuro e preciso verranno fornite sotto forma di messaggio di Cautela, Avvertenza o Nota. Questi messaggi appaiono in tutta la documentazione di manutenzione. I messaggi di Cautela, Avvertenza e Nota appaiono prima delle fasi alle quali si riferiscono. Questi messaggi dovranno essere letti prima di passare alla fase successiva della procedura. Cautela – Un messaggio di Cautela indica una procedura, pratica o condizione di funzionamento o manutenzione che, se non rigidamente osservato, potrebbe provocare un danno o una distruzione dell'apparecchiatura. Avvertenza – Un messaggio di avvertenza indica una procedura, una pratica o una condizione di funzionamento o manutenzione che, se non rigidamente osservata, potrebbe provocare una lesione personale o la perdita della vita. Nota – Un messaggio di Nota indica un problema, una pratica o una condizione di funzionamento o manutenzione che sono necessari per compiere un lavoro in modo efficiente.</p>
D	<p>Verwendung und Bedeutung der Begriffe Vorsicht, Warnung und Hinweis Informationen, die für die sichere oder ordnungsgemäße Durchführung einer Aufgabe relevant sind, werden durch die Begriffe Vorsicht, Warnung oder Hinweis angezeigt. Diese Warn- und Sicherheitshinweise sind in der gesamten Wartungsdokumentation zu finden. Warn- und Sicherheitshinweise (angezeigt durch die Begriffe Vorsicht, Warnung oder Hinweis) erscheinen jeweils vor den betreffenden Schritten. Diese Warn- und Sicherheitshinweise müssen gelesen werden, bevor mit dem nächsten Schritt eines Verfahrens fortgefahren wird.</p>

	<p>Vorsicht – Bedien- oder Wartungsverfahren, Vorgehensweisen oder Bedingungen, die, wenn sie nicht strikt beachtet werden, zu einer Beschädigung oder Zerstörung eines Geräts führen können, sind durch den Begriff „Vorsicht“ gekennzeichnet.</p> <p>Warnung – Bedien- oder Wartungsverfahren, Vorgehensweisen oder Bedingungen, die, wenn sie nicht strikt beachtet werden, zu Verletzungen oder zum Tod führen können, sind durch den Begriff „Warnung“ gekennzeichnet.</p> <p>Hinweis – Bedien- oder Wartungsverfahren, Vorgehensweisen oder Bedingungen, die zur effizienten Durchführung einer Aufgabe notwendig sind, sind durch den Begriff „Hinweis“ gekennzeichnet.</p>
NL	<p>Het gebruik van de Voorzorgsmaatregelen, Waarschuwingen en Opmerkingen Informatie betreffende de veilige en degelijke uitvoering van taken wordt voorzien in de vorm van Voorzorgsmaatregelen, Waarschuwingen of Opmerkingen. Deze vermeldingen komen vaak terug in de documentatie. Voorzorgsmaatregelen, Waarschuwingen en Opmerkingen staan bij de stappen waarop ze van toepassing zijn. U moet ze lezen voor u overgaat naar de volgende stap in een procedure. Voorzorgsmaatregel – Een Voorzorgsmaatregel geeft een bedienings- of onderhoudsprocedure, een toepassing of situatie aan die, indien deze niet streng wordt gecontroleerd, kan leiden tot schade aan of vernietiging van het toestel. Waarschuwing – Een Waarschuwing geeft een bedienings- of onderhoudsprocedure, een toepassing of situatie aan die, als deze niet streng wordt gecontroleerd, tot lichamelijke letsels of de dood kan leiden. Opmerking – Een Opmerking geeft een bedienings- of onderhoudsprocedure, een toepassing of situatie aan die vereist is om een taak goed uit te voeren.</p>
PT	<p>Declarações de advertência, alerta e observações As informações referentes à conclusão de uma tarefa de forma segura ou completa serão fornecidas na forma de declarações de uma advertência, um alerta ou uma observação. Estas declarações são encontradas em toda a documentação dos serviços. As declarações de advertências, alerta e declarações aparecem antes dos passos a que elas se aplicam. Antes de continuar para a próxima etapa de um procedimento, leia estas declarações. Advertência- Uma declaração de advertência indica que uma operação ou procedimento de manutenção, prática ou uma condição que, se não for rigorosamente respeitada, pode causar dano ou destruição ao equipamento.</p>

	<p>Alerta - Uma declaração de alerta indica que uma operação ou procedimento de manutenção, prática ou uma condição que, se não for rigorosamente respeitada, pode causar lesões corporais ou a morte.</p> <p>Observação - Uma declaração indica um problema operacional ou de manutenção, prática ou condição que é necessária para a execução de uma tarefa com eficiência.</p>
RU	<p>Использование предупреждающих обозначений техники безопасности Информация в отношении выполнения работ безопасным и эффективным образом предоставлена в в виде предупреждающих обозначений «Осторожно», «Опасно» и «Внимание». Данные обозначения используются во всех разделах эксплуатационной документации. Обозначения «Осторожно», «Опасно» и «Внимание» приведены непосредственно перед операциями, к которым они относятся. С данными предписаниями необходимо ознакомиться до того, как приступить к выполнению следующей операции регламента. Осторожно – Предписание «Осторожно» обозначает порядок, правило или режим эксплуатации или технического обслуживания, несоблюдение которого может привести к повреждению или выходу из строя оборудования. Опасно - Предписание «Опасно» обозначает порядок, правило или режим эксплуатации или технического обслуживания, несоблюдение которого может привести к несчастному случаю или летальному исходу. Внимание - Предписание «Внимание» обозначает проблему, правило или режим эксплуатации или технического обслуживания, которые следует принять во внимание для выполнения задачи эффективным образом.</p>
CHI	<p>当心、警告和注释声明 通过当心、警告和注释声明形式提供了安全、全面地完成的相关任务的信息。可在维修文档中找到这些声明。 在每个适用步骤前面显示当心、警告和注释声明。在执行程序后续步骤之前，请仔细阅读这些声明。 当心 - 当心声明指示如果不严格遵守操作或维护程序、做法或条件，可导致设备损坏或破坏。 警告 - 警告声明指示如果不严格遵守操作或维护程序、做法或条件，可导致人员受伤或死亡。 注释 - 注释声明指示为有效完成任务而需要的一种运行或维护问题、做法或条件。</p>

	<p>Safety Devices The GBC FuturoPunch Pro has several safety devices designed to prevent personal injury when operating the machine.</p> <p>Door Interlock When you open the Front Door, a Safety Interlock device automatically disables the drive motors until you close the Front Door.</p> <p>When the Front Door is open, the Operator Panel displays the “CLOSE DOOR” message on the top line of the interface.</p> <p>When you close the Front Door, the Operator Panel displays the “READY” message on the top line of the interface.</p> <p>Operational Safety Do not operate the GBC FuturoPunch Pro with the interlocks defeated.</p> <p>Use care when a procedure in this Manual instructs you to “insert an Interlock Cheater into the Punch Door interlock Switch SW1,” in order to test the operation of a component.</p> <p style="text-align: center;">WARNING</p> <p>Moving Parts, keep hands clear of nips and the belts when the Interlock Cheater is inserted.</p> <p>Do not open any panels other than those indicated by this Manual. Pay particular attention to the WARNINGS and CAUTIONS listed in the Operator Manual.</p> <p>Warnings and Cautions Pinch Points</p> <div data-bbox="231 922 636 1101" style="border: 1px solid black; padding: 5px;">  <div style="background-color: yellow; padding: 2px; text-align: center;">⚠ CAUTION</div> <div style="background-color: black; color: white; padding: 2px; text-align: center;">PINCH POINTS KEEP HANDS CLEAR</div> </div> <p style="text-align: center;">WARNING</p> <p>Moving Parts, keep hands clear of the belts when the Rear Cover Assembly is removed.</p> <p>The Punch Module Motor Belt (PL 3.1) is a potential pinch point.</p>
F	<p>Dispositifs de sécurité Le FuturoPunch Pro de GBC possède plusieurs dispositifs de sécurité prévus pour éviter les blessures corporelles lorsqu'on utilise la machine.</p> <p>Verrouillage des portes</p>

	<p>Lorsque vous ouvrez la porte avant, un dispositif de verrouillage de sécurité désactive automatiquement les moteurs d'entraînement jusqu'à ce que la porte soit refermée.</p> <p>Lorsque la porte avant est ouverte, le panneau de l'opérateur affiche le message « FERMER LA PORTE » sur la ligne du haut de l'interface.</p> <p>Lorsque vous refermez la porte avant, le panneau de l'opérateur affiche le message « PRÊT » sur la ligne du haut de l'interface.</p> <p>Sécurité d'utilisation Ne pas mettre le FuturoPunch Pro de GBC en marche si les verrouillages ne sont pas en place.</p> <p>Soyez prudent lorsqu'une procédure dans ce manuel vous demande « d'introduire une broche de verrouillage dans le commutateur SW1 de verrouillage de la porte de perforation », pour tester le fonctionnement d'un composant.</p> <p style="text-align: center;">AVERTISSEMENT</p> <p>Pièces mobiles, éloignez vos mains des contacts et des courroies lorsque la broche de verrouillage est insérée.</p> <p>N'ouvrez aucun autre panneau que ceux indiqués dans ce manuel. Soyez particulièrement attentif aux AVERTISSEMENTS et aux MISES EN GARDE indiqués dans le manuel d'utilisation.</p> <p>Avertissements et mises en garde Points de pincement</p> <div data-bbox="1186 831 1600 1010" style="border: 1px solid black; padding: 5px;">  <div style="background-color: yellow; padding: 2px; text-align: center;">⚠ MISE EN GARDE</div> <div style="background-color: black; color: white; padding: 2px; text-align: center;">POINTS DE PINCEMENT ÉLOIGNEZ VOS MAINS</div> </div> <p style="text-align: center;">AVERTISSEMENT</p> <p>Pièces mobiles, éloignez les mains des courroies lorsque l'ensemble de couvercle arrière est retiré.</p> <p>La courroie du moteur du module de poinçonnement (PL 3.1.) est un point de pincement possible.</p>
E	<p>Dispositivos de seguridad El equipo GBC FuturoPunch Pro tiene varios dispositivos de seguridad diseñados para evitar lesiones personales cuando se opera la máquina.</p> <p>Inter-bloqueo de puerta Cuando se abre la puerta delantera, un dispositivo de inter-bloqueo de seguridad desactiva automáticamente los motores de tracción hasta que se cierra la puerta delantera.</p>

	<p>Cuando la puerta delantera está abierta, el Panel de control muestra el mensaje "CLOSE DOOR" (cerrar la puerta) en la línea superior de la interfaz.</p> <p>Cuando la puerta delantera se cierra, el Panel de control muestra el mensaje "READY" (equipo listo) en la línea superior de la interfaz.</p> <p>Seguridad de operación</p> <p>No opere el equipo GBC FuturoPunch Pro con los inter-bloqueos desactivados.</p> <p>Tenga cuidado cuando un procedimiento en este manual le indique que "inserte un emulador de inter-bloqueo en el interruptor de bloqueo SW1 de la puerta de la perforadora" para probar el funcionamiento de un componente.</p> <p style="text-align: center;">ADVERTENCIA</p> <p>Piezas móviles, mantenga las manos alejadas y absténgase de tocar las correas para evitar pellizcos cuando el emulador de inter-bloqueo esté insertado.</p> <p>No abra otros paneles que no sean los indicados en este Manual. Preste especial atención a las ADVERTENCIAS y PRECAUCIONES indicadas en el Manual del operador.</p> <p>Advertencias y Precauciones</p> <p>Puntos de pellizco</p> <div data-bbox="289 829 701 1008" style="border: 1px solid black; padding: 5px;">  <p style="text-align: center;">PRECAUCIÓN</p> <p style="text-align: center;">PUNTOS DE PELLIZCO MANTENGA LAS MANOS ALEJADAS</p> </div> <p style="text-align: center;">ADVERTENCIA</p> <p>Piezas móviles, mantenga las manos alejadas de las correas cuando la cubierta posterior se haya removido.</p> <p>La correa del motor del módulo perforador (PL 3.1) es un punto potencial de pellizco.</p>
I	<p>Dispositivos de seguridad</p> <p>L'FuturoPunch Pro GBC dispone de diversi dispositivi di sicurezza studiati per evitare lesioni personali quando la macchina è in funzione.</p> <p>Interblocco sportello</p> <p>Quando si apre lo Sportello frontale, un dispositivo di Interblocco di sicurezza disabilita I motori di alimentazione finché non si richiude lo Sportello frontale.</p>

	<p>Quando lo Sportello anteriore è aperto, il Pannello operatore mostra il messaggio "CHIUDERE LO SPORTELLLO" sulla linea superiore dell'interfaccia.</p> <p>Quando si chiude lo Sportello frontale, il Pannello operatore mostra il messaggio "PRONTO" sulla linea superiore dell'interfaccia.</p> <p>Sicurezza operativa</p> <p>Non far funzionare l'FuturoPunch Pro GBC con gli interblocchi disattivati.</p> <p>Fare attenzione quando una procedura di questo Manuale indica di "inserire un Regolatore di interblocco nell'Interruttore di interblocco dello sportello della punzonatrice SW1," per testare il funzionamento di un componente.</p> <p style="text-align: center;">AVVERTENZA</p> <p>Parti in movimento, non toccare i morsetti e le cinghie quando il Regolatore di interblocco è inserito.</p> <p>Non aprire alcun pannello diverso da quelli indicati in questo Manuale.</p> <p>Fare particolare attenzione alle AVVERTENZE e CAUTELE elencate nel Manuale operatore.</p> <p>Avvertenze e Cautele</p> <p>Punti critici</p> <div data-bbox="1241 797 1598 976" style="border: 1px solid black; padding: 5px;">  <p style="text-align: center;">CAUTELA</p> <p style="text-align: center;">PUNTI CRITICI NON TOCCARE</p> </div> <p style="text-align: center;">AVVERTENZA</p> <p>Parti in movimento, non toccare le cinghie quando viene rimosso il Gruppo coperchio posteriore.</p> <p>La Cinghia del motore del modulo di punzonatura (PL 3.1) è un potenziale punto critico.</p>
D	<p>Sicherheitsvorrichtungen</p> <p>Der GBC FuturoPunch Pro verfügt über mehrere Sicherheitsvorrichtungen, die den Bediener vor Verletzungen beim Betrieb der Maschine schützen.</p> <p>Türverriegelung</p> <p>Wenn die Vordertür geöffnet wird, deaktiviert eine Sicherheitsverriegelungsvorrichtung automatisch die Antriebsmotoren, bis die Vordertür wieder geschlossen wird.</p> <p>Wenn die Vordertür geöffnet ist, wird auf der Bedienkonsole in der ersten Zeile der Anzeige die Meldung „CLOSE DOOR“ (Tür schließen) angezeigt.</p>

	<p>Wenn die Vordertür geschlossen wird, wird auf der Bedienkonsole in der ersten Zeile der Anzeige die Meldung „READY“ (bereit) angezeigt.</p> <p>Betriebssicherheit</p> <p>Der GBC FuturoPunch Pro darf nicht in Betrieb genommen werden, wenn die Verriegelungen außer Kraft gesetzt wurden. Vorsichtig vorgehen, wenn ein Verfahren in diesem Handbuch zum Testen der Funktion eines Bauteils folgende Anweisung enthält: „eine Verriegelungsüberbrückung (Interlock Cheater) in den Türverriegelungsschalter SW1 des Lochers einsetzen“.</p> <p>WARNUNG</p> <p>Bewegliche Teile, Hände von den Walzenspalten und Riemen fernhalten, wenn die Verriegelungsüberbrückung (Interlock Cheater) eingesetzt ist.</p> <p>Keine anderen als die in diesem Handbuch genannten Abdeckungen öffnen.</p> <p>Besonders auf die in diesem Handbuch enthaltenen Warn- und Sicherheitshinweise achten, die mit den Begriffen „WARNUNG“ und „VORSICHT“ gekennzeichnet sind.</p> <p>Warn- und Sicherheitshinweise (Warnung und Vorsicht)</p> <p>Quetschgefahr</p>  <p>WARNUNG</p> <p>Bewegliche Teile, Hände von den Riemen fernhalten, wenn die hintere Abdeckungsbaugruppe entfernt wurde.</p> <p>Am Motorriemen des Stanzmoduls (PL 3.1) besteht die Gefahr von Handverletzungen (Quetschgefahr).</p>
NL	<p>Veiligheidsinrichtingen</p> <p>De GBC FuturoPunch Pro heeft verschillende veiligheidsinrichtingen om lichamelijke letsels tijdens bediening van het toestel te voorkomen.</p> <p>Deurvergrendeling</p> <p>Als u het deurtje aan de voorkant opent dan zal een vergrendelingsinrichting automatisch de motor uitschakelen tot u het deurtje vooraan sluit.</p> <p>Als het deurtje vooraan open is dan verschijnt het bericht “CLOSE DOOR (SLUIT DEUR)” op de bovenste regel van de interface.</p> <p>Als u het deurtje vooraan sluit dan verschijnt het bericht “READY (KLAAR)” op de bovenste regel van de interface.</p>

	<p>Veiligheidsvoorschriften</p> <p>Bedien de GBC FuturoPunch Pro niet als de vergrendelingen uitgeschakeld zijn.</p> <p>Wees voorzichtig wanneer een procedure uit deze Handleiding aangeeft dat u “een cheater (stukje om vergrendeling te omzeilen) moet plaatsen op de vergrendelingsschakelaar SW1 van de ponsdeur” om de werking van een onderdeel te testen.</p> <p>WAARSCHUWING</p> <p>Bewegende delen, houd uw handen uit de buurt van de spleten en de riemen als de cheater (stukje om vergrendeling te omzeilen) van de vergrendeling geplaatst is.</p> <p>Open enkel de panelen waarvoor instructie werd gegeven in deze Handleiding.</p> <p>Let bijzonder goed op de WAARSCHUWINGEN en VOORZORGSMAATREGELEN in de Handleiding.</p> <p>Waarschuwingen en Voorzorgsmaatregelen</p> <p>Klempunten</p>  <p>WAARSCHUWING</p> <p>Bewegende delen, houd uw handen op afstand van de riemen als het achterste deksel verwijderd is.</p> <p>De riem van de ponsmodule (PL 3.1) is een mogelijk klempunt.</p>
PT	<p>Dispositivos de segurança</p> <p>O GBC FuturoPunch Pro tem vários dispositivos de segurança designados para prevenir lesões corporais durante a operação da máquina.</p> <p>Bloqueio da porta</p> <p>Ao abrir a porta dianteira, um dispositivo de segurança de bloqueio desativará automaticamente os motores de acionamento até você fechar a porta dianteira.</p> <p>Quando a porta dianteira estiver aberta, o painel do operador exibirá a mensagem "FECHAR A PORTA" na linha superior da interface.</p> <p>Ao fechar a porta dianteira, o painel do operador exibirá a mensagem "PRONTO" na linha superior da interface.</p> <p>Segurança operacional</p> <p>Não opere o GBC FuturoPunch Pro com dispositivos de bloqueio que apresentem problemas.</p>

	<p>Tome cuidado quando um procedimento deste manual solicitar para que você "insira o bloqueador no interruptor SW1 de bloqueio da porta de perfuração," para testar o funcionamento de um componente.</p> <p style="text-align: center;">AVISO</p> <p>Mantenha as mãos distantes dos estreitamentos e das correias quando o bloqueador for introduzido nas peças móveis.</p> <p>Não abra nenhum painel que não seja o indicado por este manual. Dê atenção especial para os ALERTAS e ADVERTÊNCIAS no Manual do operador.</p> <p>Alertas e Advertências Pontos de esmagamento</p>  <p style="text-align: center;">AVISO</p> <p>Mantenha as mãos distantes das correias quando o conjunto da tampa traseira for retirado.</p> <p>A correia do motor do módulo Punch (PL 3.1) é um ponto de esmagamento potencial.</p>
RU	<p>Устройства безопасности Перфоратор GBC FuturoPunch Pro оснащен рядом устройств безопасности, предназначенных для предотвращения несчастных случаев в ходе эксплуатации устройства.</p> <p>Блокировочное устройство дверцы При открытии передней дверцы предохранительное блокировочное устройство автоматически отключает приводные электродвигатели до тех пор, пока не будет закрыта передняя дверца.</p> <p>При открытой передней дверце на верхней строчке интерфейса панели управления высвечивается сообщение «ЗАКРЫТЬ ДВЕРЦУ».</p> <p>При закрытии передней дверце на верхней строчке интерфейса панели управления высвечивается сообщение «ГОТОВО».</p> <p>Техника безопасности Не допускается использовать перфоратор GBC FuturoPunch Pro при неработающих блокировочных устройствах.</p>

	<p>Соблюдать осторожность, если с целью испытания работоспособности узла какая-либо операция, приведенная в настоящем Руководстве, предусматривает использование вставного ключа отключения блокировки в выключателе блокировки дверцы перфоратора SW1.</p> <p style="text-align: center;">ВНИМАНИЕ</p> <p>Движущиеся части – не прикасаться к валкам и ремням при вставленном ключе отключения блокировки.</p> <p>Не открывать никакие панели, если это не предусмотрено настоящим Руководством.</p> <p>Обращать особое внимание на предупредительные обозначения ОПАСНО и ОСТОРОЖНО, приведенные в Руководстве по эксплуатации.</p> <p>Предупредительные надписи Места заземления</p>  <p style="text-align: center;">ВНИМАНИЕ</p> <p>Движущиеся части – не прикасаться к ремням при снятом узле задней крышки.</p> <p>Ремень электродвигателя модуля перфорирования (PL 3.1) является местом возможного заземления.</p>
CHI	<p>安全设备 GBC FuturoPunch Pro带有几种安全设备，设计用于防止人员在操作机器时受到伤害。</p> <p>门连锁装置 当您打开前门时，安全连锁装置自动禁用驱动电机，直到您关闭前门为止。</p> <p>当前门打开时，操作员面板在界面的第一行显示“门关闭”消息。当前门关闭时，操作员面板在界面的第一行显示“就绪”消息。</p> <p>操作安全性 不得在连锁装置失效情况下操作 GBC FuturoPunch Pro。如果手册中的程序指示“把连锁杆插入冲压机门连锁装置开关 SW1”，此时应当心，用于测试零部件的运行情况。</p>

警告

移动零件时，当插入连锁装置时，请将手远离尖锐凸起和皮带。

除非本手册中作出规定，否则不得打开任何面板。

请特别注意操作员手册中列出的警告和当心。

警告和当心

夹紧点



警告

移动零件时，在取下后盖总成时不得将手靠近皮带。

冲压模块电机皮带 (PL 3.1) 为潜在卡夹点。

Safety Devices

See page number xii for other languages

The GBC FuturoPunch Pro has several safety devices designed to prevent personal injury when operating the machine.

Door Interlock

When you open the Front Door, a Safety Interlock device automatically disables the drive motors until you close the Front Door.

When the Front Door is open, the Operator Panel displays the “CLOSE DOOR” message on the top line of the interface.

When you close the Front Door, the Operator Panel displays the “READY” message on the top line of the interface.

Other Information

The Use of Caution, Warning, and Note statements

See page number x for other languages

Information relative to the completion of a task in a safe or thorough manner will be supplied in the form of a Caution, a Warning, or a Note statement. These statements are found throughout the service documentation.

Cautions, Warnings, and Note statements appear before the steps to which they apply. These statements should be read before continuing to the next step in a procedure.

Caution - A Caution statement indicates an operating or maintenance procedure, practice, or condition that, if not strictly observed, could result in damage to, or destruction of, equipment.

Warning - A Warning statement indicates an operating or maintenance procedure, practice, or condition that, if not strictly observed, could result in personal injury or loss of life.

Note - A Note statement indicates an operating or maintenance problem, practice, or condition that is necessary to accomplish a task efficiently.

Operational Safety

Do not operate the GBC FuturoPunch Pro with the interlocks defeated.

Use care when a procedure in this Manual instructs you to “insert an Interlock Cheater into the Punch Door interlock Switch SW1,” in order to test the operation of a component.

WARNING

Moving Parts, keep hands clear of nips and the belts when the Interlock Cheater is inserted.

Do not open any panels other than those indicated by this Manual.

- Pay particular attention to the WARNINGS and CAUTIONS listed in the Operator Manual.

Warnings and Cautions

Pinch Points



WARNING

Moving Parts, keep hands clear of the belts when the Rear Cover Assembly is removed.

The Punch Module Motor Belt (PL 3.1) is a potential pinch point.

Shock Hazard



WARNING

Electrical Shock Hazard.

Do not open. No user serviceable parts inside. Refer servicing to qualified service personnel.

The electrical components behind the Rear Cover Assembly (PL 2.6) are a potential shock hazard.

Acronyms

Acronyms are used in the parts list to provide information in a limited amount of space. The following table lists the abbreviations used in this manual:

Acronym	Meaning
CBL	Cable
DRV	Motor Driver (Stepper Board)
F	Fuse
FAN	Fan
GND	Ground
M	Motor
P	Plug
J	Connector
PSU	Power Supply
S	Sensor
SW	Switch
SOL	Solenoid
UI	User Interface

The list above uses standard Xerox nomenclature.

Reference Symbology

Notes, adjustments, and parts lists, support the checklists and the RAP information. The symbols that refer to this supportive data are shown below.

Adjustment



ADJ 3.2

The mechanical adjustment symbol indicates the component is adjustable and the number identifies the adjustment procedure location in the Repair and Adjustments section of this manual.

Note

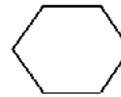

This symbol is used to refer to notes usually found on the same page.

Parts List

[PL 1.2] refers to the parts list located in Section 5 of this Service Documentation. The number after the PL designation indicates the number that is assigned to that parts list.

1. Service Call Procedures

Section Contents

Service Call Procedures

Title	Page
CALL FLOW.....	1-2
INITIAL ACTION	1-3
SYSTEM CHECKS	1-3
EVERY CALL ACTIVITIES	1-4
SCHEDULED MAINTENANCE	1-4
PREVENTATIVE MAINTENANCE	1-4
FuturoPunch Pro Maintenance Schedule	1-5
Customer Maintenance.....	1-5
Periodic Maintenance	1-5
Periodic Replacement.....	1-6
HFSI.....	1-7
FINAL ACTION	1-7

CALL FLOW

INITIAL ACTION

This step is used to gather information about the reason for the call, to determine the machine condition, and to run a punch sample if possible



SYSTEM CHECKS

This step is used to suggest a direction for using the information obtained during Initial Action. You can then repair and verify the repair of the problem. This step may also provide information to assist in the identification of new problems and suggest actions to take to repair/resolve them.



FINAL ACTIONS

This step is used to ensure that the punch quality, the punch performance, and the punch appearance are satisfactory. It will also provide direction to help complete administrative tasks.

INITIAL ACTION

At the start of every service call, you should perform the following.

1. If called for a problem, determine the exact nature of the service complaint. Determine the paper type and quality, especially as it relates to curl and identify if any media changes correlate with the emergence of the customer issue.
2. Do GP 6.1.11 PUNCH CYCLES to note down the total machine punch cycles.
3. Do GP 6.1.10 DIE CYCLES Procedure to check the cycle life on the Die Set installed in the Advance Punch Pro.
4. If any of the Die Set life cycles have exceeded 750,000 sheets (cycles) go to Section 3 and check the Hole Quality.

DIE CYCLES	↩
750,129	

- If the Hole Quality is acceptable monitor the Hole Quality frequently to ensure that the Hole Quality is okay.
 - If the Hole Quality is not acceptable advise the customer to contact Xerox to order a replacement Die Set.
5. Determine if the customer uses only one Die Set pattern (style) or if they switch between different patterns.
 6. Determine the last time the Die Set was lubricated. Perform GP 6.7.3 to lubricate die if necessary.
 7. Determine the date of the last preventative maintenance performed on the punch system. Perform Preventative Maintenance using the *FuturoPunch Pro Maintenance Schedule* on page 1-5 if needed.
 8. Vacuum all paper path, punch, dust box area of scrap/debris.

SYSTEM CHECKS

Purpose

Direct repair activity for problems found in Initial Action.

PROCEDURE

1. Select the appropriate condition from the list below and perform the directed service actions.
 - Replace any obviously broken parts.
 - If there is a Punch Quality problem, go to 3.2 Defect Entry RAP in Section 3.
 - If there is a Fault Code, go to Section 2 Table of Contents. Locate and perform the FAULT CODE RAP associated with the Fault Code.
 - If there is an Operator Message that will not clear, go to Section 2 Table of Contents. Locate and perform the steps in the OPERATOR MESSAGE RAP associated with the Operator Message.
 - If there is No Fault Code or Operator Message associated with the problem, go to Section 2 Table of Contents. Locate and perform the OTHER FAULTS RAP which most closely matches the problem described by the customer.
 - If the problem is not repeatable, operate the FuturoPunch Pro in the same job conditions the customer used and recheck for a problem in the categories listed here.
 - If the problem is still not reproduced, examine the Machine Service Log and note any repeating faults. Refer to the RAP for those faults in Section 2 to check if the RAP relates to the customer problem. If so, perform the RAP.
 - If the problem is not resolved after 2 hours, escalate to Xerox 2nd level support.
 - If none of the above situations apply, go to EVERY CALL ACTIVITIES.
2. Verify that the problem is corrected and go to EVERY CALL ACTIVITIES.

EVERY CALL ACTIVITIES

Purpose

List service activities required on every service call.

PROCEDURE

1. Perform GP 6.5 Operational Inspection.
2. Perform GP 6.6 Internal Inspection.
3. Perform GP 6.8 External Cleaning.
4. Perform GP 6.9 Internal Cleaning
5. Perform GP 6.10 Base Cleaning
6. Perform GP 6.11 Chip Bin Cleaning
7. Perform GP 6.12 Die Guide Cleaning
8. Perform GP 6.17 Optical Sensor Cleaning

SCHEDULED MAINTENANCE

Purpose

Check the supply of customer consumables (See Section 5 for customer consumable part numbers).

PROCEDURE

1. Do GP 6.1.10 DIE CYCLES Procedure to check the cycle life on the Die Set installed in the Advance Punch Pro.
2. See the FuturoPunch Pro Maintenance Schedule on page 1-5.

PREVENTATIVE MAINTENANCE

Purpose

If operating properly, the FuturoPunch Pro will punch the same types of copy paper and cover materials handled by the printer and run at the same speed.

Hole quality will vary between different grades of paper.

See the *FuturoPunch Pro Maintenance Schedule* on page 1-5.

FuturoPunch Pro Maintenance Schedule

Note: cycles = sheets of paper punched, not impressions.

Customer Maintenance

Area/Unit	Period	See:	Measures	Remarks
Punch Die	100K Die cycles	GP 6.7.3	Lubrication	Oil the punch pins
Die set shoulder bolts	200k Die cycles	GP 6.7.4	Inspect and lubricate	Grease

Periodic Maintenance

Area/Unit	Period	See:	Measures	Remarks
Punch Drive Cams	5000K cycles	GP 6.20	Inspect and lubricate	
Punch Motor Belt	1,000K cycles	GP 6.21	Inspect	
Alignment Stepper Belt	1,000K cycles	GP 6.21	Inspect	
Steering Carriage Belt	1,000K cycles	GP 6.21	Inspect	
Steering Rollers	1,000K cycles	GP 6.14	Inspect and clean	Alcohol and Cloth
Punch Clutch Cleaning	1,000K cycles	GP 6.24	Clean	Cloth
Sensors S1 to S28	500K cycles	GP 6.17	Clean	Air
Drive and Idler Rollers	1,000K cycles	GP 6.14 & GP 6.15	Inspect and clean	Alcohol & cloth
Solenoid Module	1,000K cycles	GP 6.22	Inspect	
Idler Panel Closing Magnet Latches	1,000K cycles	GP 6.16	Inspect	
Acceleration Panel Latch	1,000K cycles	GP 6.16	Inspect	
Paper Path Drive Timing Belts	1,000K cycles	GP 6.21	Inspect and Adjust if necessary	
Diverter Solenoid Assembly	1,000K cycles	GP 6.25	Inspect	
Die Set Recognition Board Clips	1,000K cycles	GP 6.26	Clean	Cloth
Alignment Carriage Rails	500K Cycles	GP 6.23	Inspect and Clean	Air and Cloth
Die Lock Mechanism and Die Rail Springs	1000K Cycles	GP 6.27	Inspect	
Die guide (rail) cleaning	500K cycles	GP 6.12	Clean	Vacuum
Paper path	1000K cycles	GP 6.18 & GP 6.19	Inspect and clean	Cloth

Periodic Replacement

Area/Unit	Part Number	Qty. per machine	Rough Standard	Remarks
Die Set	See PL 6	1	750K Cycles	Replacement
Punch Module	180N00019 (115V), PL 5.1 180N00020 (230V), PL 5.1	1	15M Cycles	Replacement
Solenoid module	133N23254, PL 4.6	6	5M Cycles	Replacement

HFSI

Replace the part if over threshold (See Pages 1-5 and 1-6).

Note down the DIE CYCLE counts (GP 6.1.10) and PUNCH CYCLE count (GP 6.1.11) when performing HFSI.

FINAL ACTION

This section explains the actions a technician should take at the end of every service call. With each step, verify that the system runs smoothly and paper jam free.

Purpose

Ensure acceptable punch quality, punch performance, and punch appearance are satisfactory and to complete administrative tasks.

PROCEDURE

1. Install/close all covers and doors.
2. Inspect each Die Set visually and lubricate as needed. See GP 6.7, Die Set Service
3. Use the customer's primary Die Set pattern to run 200 simplex printed test sheets through the punch mode and examine the output for clean hole quality and even hole alignment.
4. Use the customer's primary Die Set pattern to run 200 duplex printed test sheets through the punch mode and examine the output for clean hole quality and even hole alignment.
5. Use any of the customer's secondary Die Set pattern to run 100 simplex printed test sheets through the punch mode and examine the output for clean hole quality and even hole alignment.
6. Run 100 sheets simplex and 100 sheets duplex through the punch bypass mode.
7. Clean out all paper chips (chad) and paper dust from the chip tray, the bottom of the machine and from the floor around the bottom of the machine. See GP 6.10 Base Cleaning.
8. Explain to the customer the service work that was performed and ensure they are satisfied before you close the call.

Service Call Close

1. Record your service activities along with the Punch Cycle Count.

Notes:

2. Repair Analysis Procedures (RAPS)

Section Contents

Title	Page
Introduction	2-3
Symbology.....	2-3
Entry RAP.....	2-4
OPERATOR MESSAGES	2-5
Top Row of Text.....	2-5
Bottom Row of Text.....	2-5
Check Die.....	2-6
Close Door	2-8
Chip Tray Out.....	2-9
Chip Tray Out message is not displayed when the Chip tray is out	2-9
Chip Tray Full.....	2-10
ERROR CODES	2-11
ERROR E451 DIE ENCRYPTION ERROR.....	2-11
ERROR E452 INCOMPATIBLE DIE.....	2-11
FAULT CODES	2-12
Fault Code Text.....	2-12
Fault Code Areas	2-12
Jam Types.....	2-13
1 POWER FAULTS	2-14
RAP 1.1 No AC Power.....	2-14
RAP 1.2 No DC Power	2-16
RAP 1.3 No Power to Control Board	2-17
RAP 1.4 Operator Panel Does Not Illuminate	2-18
RAP 1.5 Operator Panel Does Not Show Text.....	2-19
RAP 1.6 Up, Down, Enter Keys Do Not Respond	2-20
2 PAPER JAMS	2-20
RAP 2.1 Jam Type A.....	2-20
RAP 2.2 Jam Type B	2-21

RAP 2.3 Jam Type C	2-22
RAP 2.4 Jam Type D	2-24
RAP 2.5 Jam Type E	2-25
RAP 2.6 Jam Type F.....	2-26
RAP 2.7 Multiple Sheets Jammed - Die Pins Partially Through the Sheets	2-27
RAP 2.8 Checking Obstruction in Paper Path	2-28
RAP 2.9 PAPER JAM J431	2-31
RAP 2.10 PAPER JAM J432	2-31
RAP 2.11 PAPER JAM J433	2-32
3 SENSOR CHECKS	2-33
RAP 3.1 Check Sensors S1, S2, S3, S4, S5, S22, S23, S24, S25, S26	2-33
Sensor Cables	2-35
RAP 3.2 Check Sensors S6 to S21	2-36
RAP 3.3 Checking Sensor S28 Align Home Sensor	2-41
4 SOLENOID CHECKS	2-43
RAP 4.1 Check Solenoid SOL 1	2-43
RAP 4.2 Check Solenoid SOL 2	2-43
RAP 4.3 Check Solenoids SOL 3 to SOL 8	2-44
5 MOTOR CHECKS	2-46
RAP 5.1 Checking Stepper Motors.....	2-46
6 OTHER FAULTS	2-48
RAP 6.1 Die Set Will Not Slide In or Out Easily.....	2-48
RAP 6.2 Punch Overheats.....	2-48
RAP 6.3 Dog ear corners in sheets	2-49
Appendix	2-50
Jam Codes	2-50

Introduction

This section contains the Repair Analysis Procedures (RAPs).

Organization

This section lists the Repair Analysis Procedure (RAP) for each Operator Message and Fault Code. In some cases, one Repair Analysis Procedure may apply to several Fault Codes. In those cases, subsequent Fault Codes include a cross reference to the pertinent RAP.

To help you locate each component, the Repair Analysis Procedures include part locators (PL x.y) that refer to the pertinent page in Section 5, Part List.

Symbology



Caution – Potential damage to the machine could result unless the specified procedures are followed. See *Section 0, page viii for other languages.*

Entry RAP

Always do this RAP first.

Attempt to retrieve the number of Punch cycles (GP6.1.11) and note it down.

1. If the customer says that they have a punch quality problem, go to the Table of Contents for Section 3, and find the Punch Quality RAP that most closely fits the customer's description of the problem.

2. For the entire printing device- Power off, then power on (POPO). Check that the Punch runs properly in all modes.

For DFA configuration- Power off, then Power on the Punch using the AC power switch.

The Punch runs properly.

Y N

Go to Step 3.

Go to INITIAL ACTION in Section 1.

3. Check the top row of text on the Operator Interface to determine if there is there a operator message.

There is a operator message on line 1.

Y N

Go to Step 4.

Go to the Table of Contents for Section 2 and locate the RAP for that status message.

4. Check the top row of text on the Operator Interface to determine if there is there an Error Code.

There is a Error Code on line 1.

Y N

Go to Step 5.

Go to the Table of Contents for Section 2 and locate the RAP for that fault code.

5. Check the top row of text on the Operator Interface to determine if there is there a Fault Code.

There is a Fault Code on line 1.

Y N

Go to Step 6.

Go to the Table of Contents for Section 2 and locate the RAP for that fault code.

6. Is there a Power Fault (No AC Power, No DC Power, No power to Control Board, Operator Panel Does Not Illuminate).

There is a Power Fault.

Y N

Go to Step 7.

Go to the Table of Contents for Section 2 and locate the RAP for that power fault.

7. Is the problem one of the faults listed in Section 2 that does not generate a message on the Operator Interface (Die Set Will Not Slide Out Easily, Punch Overheats).

The problem one of the known faults that does not generate a message

Y N

Go to Step 8.

Go to the Table of Contents for Section 2 and locate the OTHER FAULTS RAP for that problem.

8. Can the operator use the Operator Interface to operate the equipment?

The operator can use the Operator Interface to operate the equipment.

Y N

Check with the customer to determine what symptom they have. Go to the Table of Contents for Section 2 and find the RAP that most closely fits the customer's description of the problem.

Go to INITIAL ACTION in Section 1.

OPERATOR MESSAGES

The Operator Panel displays status messages and fault codes on two rows of text.

READY
SINGLE PUNCH

Top Row of Text

Message	Description	Action
CLOSE DOOR	The Front Door is open.	Close the Front Door.
READY	The system is ready.	Use the Punch to punch paper or bypass the Punch.

Bottom Row of Text

Message	Description	Action
CHECK DIE	Check the Die Set	Check the Die Set
BYPASS	The Punch is in Bypass Mode	Use the Punch in Bypass Mode.
SINGLE PUNCH	The Punch is in Single Punch Mode	Use the Punch in Single Punch Mode.
<i>DOUBLE PUNCH (Available for DFA configuration only)</i>	<i>The Punch is in Double Punch Mode</i>	<i>Use the Punch in Double Punch Mode.</i>

Check Die

The CHECK DIE message indicates that the Die Set is either missing or not fully installed.

1. Open the Front Door. (PL 2.2).
2. Unlock the Dieset, and remove the Dieset (see FuturoPunch Pro User Manual).
3. Re-insert the Dieset and lock the lock it in place.

This clears the fault code.

Y N

| Go to step 4.

Normal operation.

4. Do REP 1.6 to remove the Rear Cover, and check if the Dieset Recognition Reader Board Cable- 023N01331 (see Section 7 Wiring) is connected properly at both ends (Die set recognition board and J9 in Section 7 wiring). Note that the connector has 4 pins, and it should be properly inserted.

This clears the fault code.

Y N

| Go to step 5.

Normal operation.

5. Clean the Dieset Recognition Board in the Die and the Die set Recognition Reader Board in the machine.

This clears the fault code.

Y N

| Go to step 6.

Normal operation.

6. Check if the Dieset Recognition Reader Board Spring Clips contact the Dieset Recognition Board in the Dieset.

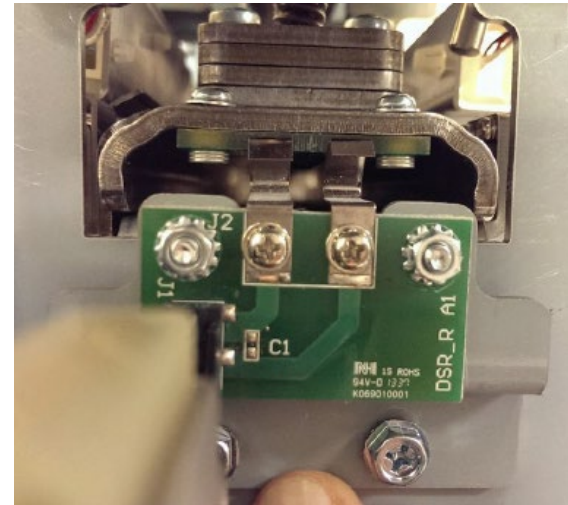

If Spring Clips look like they are broken, replace Dieset Recognition Reader Board. If the springs clips do not contact the Dieset Recognition Board, do ADJ 1.6 Dieset Recognition Board Adjustment.

This clears the fault code.

Y N

| Go to step 7.

Normal operation.

7. If there is another Dieset, check if that Dieset shows the same message.

Dieset shows the same message.

Y N

| If the issue is with just one Dieset, then escalate to second level.

If the error is still present with all the diesets, do GP 6.2.16 *FIRMWARE UPGRADE Procedure* to reflash the firmware.

This clears the fault code.

Y N

| Go to step 8.

Normal operation.

(Cont.)

8. Replace the Dieset Recognition Cable #023N01331 (PL 7.3).

This clears the fault code.

Y N

| Go to step 9.

Normal operation.

9. Do REP 5.3 to replace the Dieset Recognition Reader Board Assembly (PL 5.1).

This clears the fault code.

Y N

| Go to step 10.

Normal operation.

10. Do REP 5.1 *Main Control Board Replacement* to replace the Main Control Board (PL 7.1).

This clears the fault code.

Y N

| Escalate to second level.

Normal operation.

Close Door

The CLOSE DOOR message indicates that the Front Door is open or not completely closed.

1. Check that the Front Door is closed (PL 2.2).

The Front Doors is closed.

Y N

| Close the Front Door and return to normal operation.

2. Insert an Interlock Cheater into the Punch Door interlock Switch SW4 (PL 2.2).

WARNING

Moving Parts, keep hands clear of nips and the belts when the Interlock Cheater is inserted. See Section 0, page vii for other languages.

3. Check if the Close Front Door message is displayed.

The Close Front Door message is displayed.

Y N

| Do ADJ 1.1 Door Latch adjustment and return to normal operation

Go to Step 4.

4. Do REP 1.6 to remove the Rear Cover and check if the Interlock Cable 023N01332 (see Section 7 Wiring) is connected at J8 at the Main Control Board (PL 7.1).

Interlock Cable is connected at J8.

Y N

| Make the connection and return to normal operation.

5. Switch OFF the machine and unplug the Power Cord.

6. Remove the M4 Nuts (2) that hold the Interlock Switch Bracket (PL 2.2) and inspect the connections at the Interlock Switch (see REP 1.13 Interlock switch replacement for photos of the connections).

Interlock cable is connected at the Interlock switch.

Y N

| Make the connection and return to Normal operation

Go to step 7.

7. Inspect the connection at J17 at the Main Control Board. It is a 16 pin connector to a 16 pin terminal.

The connection at J17 is good.

Y N

| Make the connection and return to normal operation.

8. Do GP 6.2.16 Firmware Upgrade procedure to re-flash the Firmware for FuturoPunch Pro,

Re-flashing the firmware clears the fault.

Y N

| Go to Step 9.

Return to normal operation.

9. Do REP 1.13 Interlock Switch Replacement to replace the Interlock switch,.

Replacing the switch clears the fault.

Y N

| Go to Step 10.

Return to normal operation.

10. Replace Interlock Switch Cable 023N01332 (PL 7.3).

Replacing the cable clears the fault.

Y N

| Replace the Main Control Board (PL 7.1).

Return to normal operation.

Chip Tray Out

This message is displayed when the Chip tray is removed from the machine or when the chip tray is not fully inserted.

Use this procedure when the Chip Tray Out message is displayed when the Chip tray is inserted.

1. Open the Front door and insert the Chip Tray firmly.

This clears the fault.

Y N

| Go to Step 2.

Return to normal operation

2. Inspect if the Spring Clip of the Chip tray home switch (PL 3.5, SW2). If the Spring Clip is broken, do REP 2.30 Chip Tray Home Switch Replacement.

This clears the fault.

Y N

| Go to Step 3.

Return to normal operation

3. Do GP 6.2.16 Firmware Upgrade procedure to re-flash the Firmware for FuturoPunch Pro,

Re-flashing the firmware clears the fault.

Y N

| Go to Step 4.

Return to normal operation.

4. Do REP 2.30, Replace Chip Tray Home Switch,

This clears the fault.

Y N

| Go to Step 5

Return to normal operation.

5. Replace Cable 023N01327 (PL 7.3).

This clears the fault.

Y N

| Do REP 5.1 *Main Control Board Replacement* to replace the Main Control Board (PL 7.1).

Return to normal operation.

Chip Tray Out message is not displayed when the Chip tray is out

This message is displayed when the Chip Tray Out message is not displayed when the Chip tray is out.

1. Make sure the (2) spade connectors to the Chip tray home switch (PL 3.5, SW2) is securely inserted. (see REP 2.30 for details)

Connectors are securely connected.

Y N

| Securely connect the (2) spade connectors

2. Do REP 1.6 to remove the Rear Cover and check the 023N01327 cable is connected to J27 at the Main Control Board (Section 7 Wiring)

See the *Sensor Cables* table on page 2-35 for cable numbers.

The connection is good.

Y N

| Make the connection and return to normal operation.

3. Do GP 6.2.16 Firmware Upgrade procedure to re-flash the Firmware for FuturoPunch Pro,

Re-flashing the firmware clears the fault.

Y N

| Go to Step 4.

Return to normal operation.

4. Do REP 2.30, Replace Chip Tray Home Switch,

This clears the fault.

Y N

| Go to Step 5

Return to normal operation.

5. Replace Cable 023N01327 (PL 7.3).

This clears the fault.

Y N

| Do REP 5.1 *Main Control Board Replacement* to replace the Main Control Board (PL 7.1).

Return to normal operation.

Chip Tray Full

The Chip Tray full message is displayed when the punch chips fill the chip tray and the capacity is exceeded.

1. Remove the Chip tray and empty the punch chips.

This clears the fault.

Y N

| Go to Step 2.

Return to normal operation

2. Clean the Chip Level Emitter and Chip Level Receiver Sensors (PL 3.5). Ensure the sensor path is clear with the Chip Tray installed.

The Chip Level Emitter and Receiver Sensors are located in the Chip Tray cavity in the lower portion of the front frame. See REP 2.31 and 2.32 for more details.

This clears the fault

Y N

| Go to step 3.

Return to normal operation.

3. Remove the Chip Tray and check if the Chip level Emitter and Chip level Receiver (PL 3.5) are plugged in.

The Chip level emitter and receiver are located in the Chip tray cavity in the lower portion of the front frame. See REP 2.31 and REP 2.32 for more details.

See the *Sensor Cables* table on page 2-35 for cable numbers.

The connections are good.

Y N

| Make the connection and return to normal operation.

4. Do REP 1.6 to remove the Rear Cover.
5. Check if Cable 023N01327 (see Section 7 Wiring) is connected to J27 at the Main Control Board (PL 7.1).

The connection is good.

Y N

| Make the connection and return to normal operation.

Go to step 6.

6. Do GP 6.2.16 Firmware Upgrade procedure to re-flash the Firmware for FuturoPunch Pro,

Re-flashing the firmware clears the fault.

Y N

| Go to Step 7.

Return to normal operation.

7. Do REP 2.31 to replace the Chip Level Emitter (PL 3.5).

This clears the fault

Y N

| Go to Step 8.

Return to normal operation.

8. Do REP 2.32 to replace the Chip Level Receiver (PL 3.5).

This clears the fault.

Y N

| Go to Step 9.

Return to normal operation.

9. Replace cable 023N01327 (PL #)

This clears the fault.

Y N

| Do REP 5.1 to replace the Main Control Board (PL 7.1).

Return to normal operation.

ERROR CODES

The User Interface displays two error messages when the firmware detects that an item is bad or not functioning. There are only 2 error codes.

Error Code	Description
E451	Die encryption error
E452	Incompatible die

ERROR E451

DIE ENCRYPTION ERROR

The top row of text displays the fault error message number the bottom row displays the description.

NOTE: If there is an ERROR message when downloading firmware (either DFA_MAIN.BIN or DFA_COMM.BIN file), the firmware should be downloaded again.

ERROR E451 DIE ENCRYPTION ERROR

This means that the die is not a GBC certified die.

1. Open the Front Door (PL 2.1).
2. Remove the Die Set (see FuturoPunch Pro User Manual).
3. Check that the Die Set is the correct Die Set for the Punch.

The Die Set is the correct die Set for the Punch.

Y N

| Replace the Die Set (PL 6).

Escalate to second level.

ERROR E452 INCOMPATIBLE DIE

This means the die is not a certified FX/Xerox die.

1. Open the Front Door.
2. Remove the Die Set(see FuturoPunch Pro User Manual).
3. Check that the Die Set is the correct Die Set for the Punch (see FuturoPunch Pro User Manual).

The Die Set is the correct die Set for the Punch.

Y N

| Replace the Die Set (PL 6).

Escalate to second level.

FAULT CODES

The User Interface displays Fault codes on two rows of text.

PAPER JAM J622

CLEAR 6

The top row of text displays the fault code.

The bottom row of text displays the area of the Punch where the error occurred.

Fault Code Text

Each Fault code starts with the letter “J” followed by a 3-digit code.

Fault Code Areas

When you open the Front Door, the front panel of the Punch is labelled to identify the location of the six (6) areas of the machine. These numbers match the numbers in the bottom row of text.

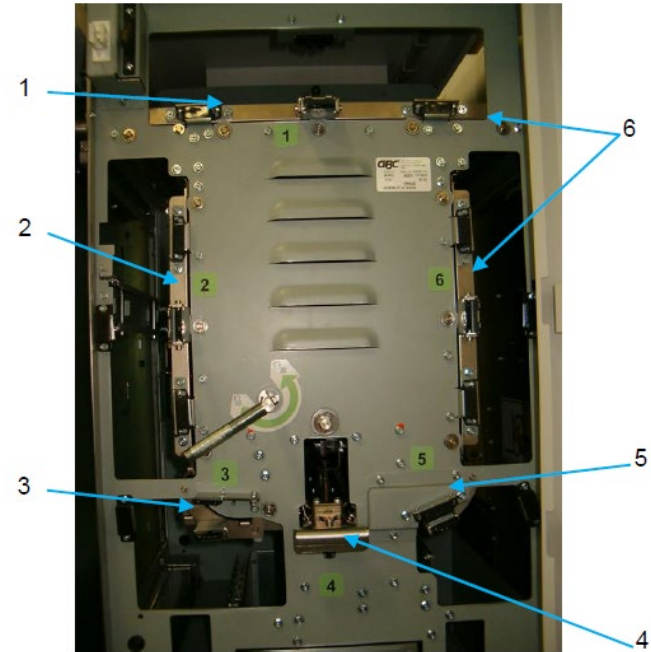

Bottom Row of Text	Area	General Location
Clear 1	Area 1	Bypass Section
Clear 2	Area 2	Entrance Idler Section
Clear 3	Area 3	Acceleration Roller Section
Clear 4	Area 4	Punch Module
Clear 5	Area 5	Lower Punch Exit Section
Clear 6	Area 6	Exit Idler Section

Jam Types

The following table lists each paper jam type. It lists Jam Type (A, B, C, etc.) and the corresponding description (position of first jammed sheet).

Jam Type	Description	RAP
Jam Type A	The lead edge of the first jammed sheet is stopped by nip N1	Do RAP 2.1 Jam Type A
Jam Type B	The lead edge of the first jammed sheet is stopped past nip N1 but before nip N5.	Do RAP 2.2 Jam Type B
Jam Type C	The lead edge of the first jammed sheet is stopped past nip N5 but before Steering Rollers N6 and N7	Do RAP 2.3 Jam Type C
Jam Type D	The lead edge of the first jammed sheet is past N6 and N7 but its trail edge is before or just past N6/N7.	Do RAP 2.4 Jam Type D
Jam Type E	The trail edge of the first jammed sheet is past Steering rollers N6 and N7	Do RAP 2.5 Jam Type E
Jam Type F	The paper jam is in the Bypass Assembly.	Do RAP 2.6 Jam Type F

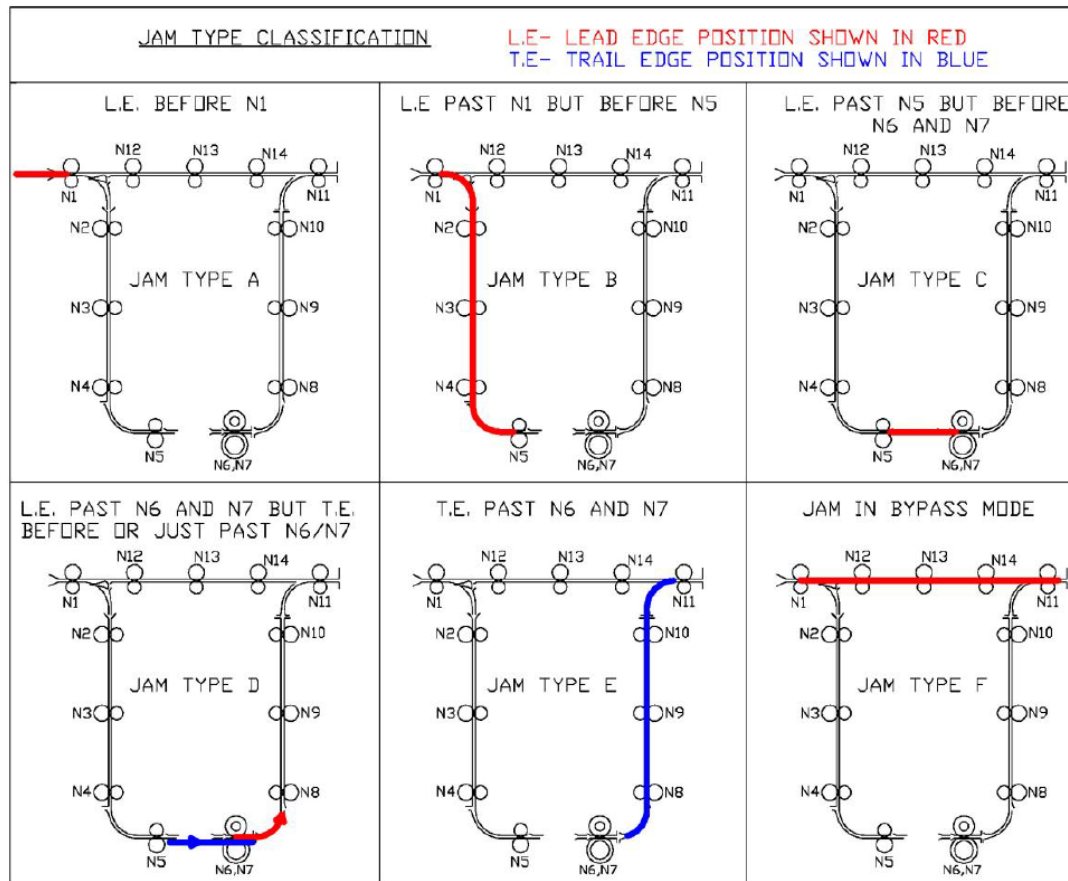

1 POWER FAULTS

RAP 1.1 No AC Power

Use this RAP when there is no AC power to the FuturoPunch Pro. The Operator Panel does not illuminate and the FuturoPunch Pro does not operate.

1. Ensure the Power is ON for the print engine. *For DFA configuration- Press the Main Power Switch to the On (I) position.*

Main Power Switch is in the On (I) position

Y N

| Place the Main Power Switch in the On (I) position.

2. Check that the Power Cord is attached to the AC Filter on the rear of the machine.

Power Cord is attached to AC Filter.

Y N

| Attach the Power Cord.

3. Check that the Power Cord is properly plugged into the wall.

Power Cord is plugged into the wall.

Y N

| Plug in the Power Cord.

4. Disconnect the Power Cord from the power source and check for input voltage - 110 VAC (60 Hz) or 240 VAC (50 Hz) - at the power receptacle.

AC power is present at the receptacle.

Y N

| If there is no power at the outlet, ask the customer to call an electrician to restore the AC power.

5. Reconnect the power cord to the FuturoPunch Pro.
6. Do REP 1.6 to remove the Rear Cover.
7. Check that Ground Wire 023N01320 (Section 7 Wiring) is connected to the ground and to the AC Filter.

Ground Wire 023N01320 is connected.

Y N

| Connect Ground Wire 023N01320.

Go to step 8.

8. Check that Cable 023N01336 (see Section 7 Wiring) is connected at the AC Filter. *For DFA configurations cable# is 023N01335*

Cable 023N01336 (023N01335 for DFA) is connected at AC Filter

Y N

| Connect Cable 023N01336 (023N01335 for DFA).

9. *For DFA configuration only- Check that Cable 023N01335 (see Section 7 Wiring) is connected to the Power Switch SW1. For OEM configurations- go to Step 10.*

Cable 023N01335 is connected to the Power Switch.

Y N

| Connect Cable 023N01335 to the Power Switch SW1.

10. Check the Fuse on the Communications Board. (Section 7 Wiring)

Fuse is okay

Y N

| Replace the Fuse (PL 7.1).

11. Check that Cable 023N01336 (see Section 7 Wiring) is connected to Pin J14 on the Communications Board. *For DFA configurations cable# is 023N01335*

Cable 023N01336 (023N01335 for DFA) is connected to Pin J14.

Y N

| Connect Cable 023N01336 (023N01335 for DFA) to Pin J14 on the Communications Board.

12. Check that Cable 023N01321 (see Section 7 Wiring) is connected to Pin J15 on the Communications Board.

Cable 023N01321 is connected to Pin J15 on the Communications Board.

Y N

| Connect Cable 023N01321 to Pin J15 on the Communications Board.

13. Check that Cable 023N01321 (see Section 7 Wiring) is connected to Pin J4 on the Main Control Board.

Cable 023N01321 is connected to Pin J4 on the Main Control Board

Y N

Connect Cable 023N01321 to Pin J4 on the Main Control Board.
Go to step 14.

14. Check for input voltage - 110 VAC (60 Hz) or 240 VAC (50 Hz) - at the AC Filter.

There is AC power at the AC Filter.

Y N

Replace the AC power cord to the AC Filter (PL 7.1).

15. *For DFA configurations only- Check for continuity at the AC Power Switch SW1 (PL 1.1).* For OEM configurations- got to Step 16.

There is continuity at the AC Power Switch.

Y N

Replace AC Power Switch SW1

16. Check for input voltage - 110 VAC (60 Hz) or 240 VAC (50 Hz) – on Cable 023N01336 (see Section 7 Wiring) at the AC Filter (BRN & BLU wires). *For DFA configurations cable# is 023N01335*

There is AC power on Cable 023N01336 (023N01335 for DFA) at the AC Filter.

Y N

Replace AC FILTER (PL 7.1).

17. Check for input voltage - 110 VAC (60 Hz) or 240 VAC (50 Hz) – on Cable 023N01336 (see Section 7 Wiring) at the Pin J14 on the Communications Board (BRN & BLU wires). *For DFA configurations cable# is 023N01335*

There is AC power on Cable 023N01336 (023N01335 for DFA) at Pin J14 on the Communications Board.

Y N

Replace Cable 023N01336 (023N01335 for DFA).

18. Check for input voltage - 110 VAC (60 Hz) or 240 VAC (50 Hz) – on Cable 023N01321 (see Section 7 Wiring) at Pin J15 on the Communications Board (BLU & BRN wires).

There is AC power on Cable 023N01321 at Pin J15 the Communications Board.

Y N

Replace the Communications Board (REP 5.2).

19. Check for input voltage - 110 VAC (60 Hz) or 240 VAC (50 Hz) – on Cable 023N01321 (See Section 7 Wiring) at Pin J4 on the Main Control Board (BLU & BRN wires)

There is AC power on Cable 023N01321 at Pin J4 the MainControl Board.

Y N

Replace Cable 023N01321

Replace the Main Control Board (REP 5.1).

RAP 1.2 No DC Power

Use this RAP when there is no indication of 24 VDC power.

1. Do REP 1.6 to remove the Rear Cover.
2. Plug in the AC power cord and turn ON the AC power switch.

WARNING

Moving Parts, keep hands clear of nips and the belts when the Interlock Cheater is inserted. See Section 0, page vii for other languages.

3. Check the LEDs on the Control Board.
 - With the front door closed there will be (4) LEDs that will be lit.
 - With the front door open, there will be (3) LEDs that will be lit.

The LEDs are lit.

Y N

| Go to step 4.

Go to step 9.

4. Check for line voltage on Cable 023N01322 (see Section 7 Wiring) at Connector J3 on the Main Control Board (PL 7.1).

There is line voltage.

Y N

| Do RAP 1.1 No AC Power.

5. Check the following connections (see Section 7 Wiring):
 - Connection of cable 023N01329 at J1 at the Main Control Board.
 - Connection of cable 023N01322 at J3 at the Main Control Board.

Connections are good.

Y N

| Make the connections then return to normal operation.

6. Do REP 4.1 to remove 24 VDC Power Supply.
7. With the power supply outside the machine, make the connections at J1 and J3 and the ground cable.

WARNING

Do not touch the open terminals of the power supply or any other connector with the AC power cord connected. The machine components contain dangerous electrical voltages that can result in electrical shock and possible serious injury. See Section 0, page viii for other languages

8. Check if the LED in the power supply is lit

LED is lit

Y N

| Go to Step 9

Go to Step 10

9. Replace Cable 023N01322 (PL 7.3)

This clears the fault.

Y N

| Go to Step 10

Return to normal operation

10. Check if there is no 24V power to any other components like a Solenoid, or a Stepper Motor,

There is no 24V power to any other components

Y N

| Go to Step 11

Replace the Main Control board (PL 7.1)

11. Check for 24 VDC on Cable 023N01329 (see Section 7 Wiring) at Connector J1 on the Control Board.

- Pin 1 = ORG Wire
- Pin 2 = ORG Wire
- Pin 3 = ORG Wire
- Pin 6 = BLK Wire
- Pin 7 = BLK Wire
- Pin 8 = BLK Wire

There is 24 VDC at Connector J1 on the Control Board

Y N

| Replace Cable 023N01322 (PL 7.3)

12. Determine if you have been directed here from another RAP because there is no 24 VDC power output from the Control Board to another component.

There is no 24 VDC power output from the Control Board to another component.

Y N

| Normal operation.

Replace the Main Control Board (PL 7.1).

RAP 1.3 No Power to Control Board

Use this RAP when there is no power to the Control Board.

1. Do RAP 1.2 No DC Power to check DC power.

RAP 1.4 Operator Panel Does Not Illuminate

Use this RAP when the LCD Display does not illuminate.

1. Power OFF the print engine and all the connected devices. For DFA configuration only- Press the Power switch to the OFF position.

2. Wait 20 seconds then power ON the device(s).

The Operator Interface illuminates.

Y N

| Go to step 3.

Normal operation.

3. Close the Front door. Check if the printer screen shows a GBC punch related fault.

Printer screen shows a GBC punch related fault

Y N

| Go to step 4.

Do RAP 1.3 No DC Power.

4. Do REP 1.6 to remove the Rear Cover.
5. Plug in the AC Power Cord and turn on the Power Switch.

WARNING

Do not perform repair activities with the power on or electrical power supplied to the machine. Some machine components contain dangerous electrical voltages that can result in electrical shock and possible serious injury. See Section 0, page vi for other languages.

6. Check the LEDs on the Control Board.

- With the front door closed there will be (4) LEDs that will be lit.
- With the front door open, there will be (3) LEDs that will be lit.

The LEDs are lit.

Y N

| Do RAP 1.2 No DC Power.

7. Check that LCD Cable 023M01337 is connected at Connector J36 on the Control Board (see Section 7 Wiring).

Cable 023M01337 is connected at Connector J36.

Y N

| Connect Cable 023M01337 (see Section 7 Wiring).

Go to step 8.

8. Check that LCD Cable 023M01337 (see Section 7 Wiring) is connected at the LCD Panel on the rear of the User Interface (PL 2.2).

Cable 023M01337 is connected at the LCD Panel.

Y N

| Connect Cable 023M01337 (see Section 7 Wiring).

9. Check the condition of LCD Cable 023M01337 (see Section 7 Wiring).

LCD Cable 023M01337 is okay.

Y N

| Replace LCD Cable 023M01337 (PL 7.3).

10. Replace the LCD Board on the rear of the User Interface (PL 2.2)

This clears the fault

Y N

| Go to Step 11

Return to normal operation

11. Check for 24 VDC on the LCD Cable 023M01337 at Connector J36 on the Main Control Board (see Section 7 Wiring).

There is 24 VDC at Connector J36.

Y N

| Do the RAP 1.3 No Power to Control Board (page 2-17) to check for 24 VDC into the Main Control Board (PL 7.1).

Replace the LCD Display (REP 1.15).

RAP 1.5 Operator Panel Does Not Show Text

Use this RAP when the LCD Display does not show text but illuminates.

1. Power OFF the print engine and all the connected devices. For DFA configuration only- Press the Power switch to the OFF position.
2. Wait 20 seconds then power ON the device(s).

The Operator Interface illuminates.

Y N

| Go to step 3.

Normal operation.

3. Check that LCD Cable 023M01337 is connected at Connector J36 on the Control Board (see Section 7 Wiring).

Cable 023M01337 is connected at Connector J36.

Y N

| Connect Cable 7715523.

4. Check that LCD Cable 7715523 is connected at the LCD Panel on the rear of the User Interface (See Section 7 Wiring and PL 2.2).

Cable 023M01337 is connected at the LCD Panel.

Y N

| Connect Cable 023M01337

5. Upload firmware: Do GP 6.1.16

The Operator Interface shows text.

Y N

| Go to step 6.

Normal operation.

6. Check the condition of LCD Cable 023M01337 (see Section 7 Wiring)

LCD Cable 023M01337 is okay.

Y N

| Replace LCD Cable 023M01337 (PL 7.3)

Go to Step 7

7. Replace the LCD Board on the rear of the User Interface (REP 1.15)

This clears the fault

Y N

| Go to Step 8

Normal operation.

8. Check LCD for normal operation.

The Operator Interface shows text.

Y N

| Replace the Main Control Board (REP 5.1).

Normal operation.

RAP 1.6 Up, Down, Enter Keys Do Not Respond

Use this RAP when the Up, Down, Enter Keys on the LCD Membrane switch do not respond.

1. Open the Front Door and check that the flat cable 023M01337 from the LCD Panel is connected to the LCD Display (see Section 7 Wiring).



The Cable is connected.

Y N

Connect the Cable 023M01337.

Do REP 1.16 LCD Membrane switch replacement.

2 PAPER JAMS

This section describes paper jams based on the position of the lead edge/ trail edge of the first jammed sheet.

RAP 2.1 Jam Type A

Do the following if the lead edge stopped by nip N1.

1. Check to see if there is any obstruction to paper flow at the entrance of the machine (PL 3.1, PL 3.2).

Do RAP 2.8 Checking Obstruction in Paper Path - Area 1 (Entrance)

This clears the fault

Yes- Return to normal operation; **No-** Go to Step 2

2. Do RAP 3.1 to check Sensors S21 and S25.

This clears the fault

Yes- Return to normal operation; **No-** Go to Step 3

3. Do RAP 5.1 *Checking Stepper Motors* to check Bypass Motor M8.

This clears the fault

Yes- Return to normal operation; **No-** Go to Step 4

4. Do *GP 6.14 Idler Roller Inspection and Cleaning* and *GP 6.15 Drive Roller Inspection and Cleaning*, to inspect and clean the rollers in Nip N1 (PL 3.4).

This clears the fault

Yes- Return to normal operation; **No-** Escalate to second level

RAP 2.2 Jam Type B

Do the following if the lead edge is stopped past nip N1 to lead edge is stopped just before nip N5.

1. Check to see if there is any obstruction in the paper path from nip N1 to nip N5 (PL 3.4).

Do RAP 2.8 Checking Obstruction in Paper Path - Area 2 (Entrance Idler Panel Assembly).

This clears the fault

Yes- Return to normal operation; **No-** Go to Step 2

2. Check Sensors S1,S2, S3,S4,S5,S18,S19,S20,S21, and S25
 - Do RAP 3.1 *Check Sensors S1, S2, S3, S4, S5, S22, S23, S24, S25, S26* and
 - Do RAP 3.2 Check Sensors S6 to S21.

This clears the fault

Yes- Return to normal operation; **No-** Go to Step 3

3. Do RAP 5.1, Checking Stepper Motors to check Motor M1 and Motor M8.

This clears the fault

Yes- Return to normal operation; **No-** Go to Step 4

4. Do RAP 4.3 Check Solenoids SOL 3 to SOL 8 to 8 to check solenoids SOL3 and SOL 4.

This clears the fault

Yes- Return to normal operation; **No-** Go to Step 5

5. Check the diverter mechanism (PL 3.3, PL 3.8). Do RAP 4.1 Check Solenoid SOL 1.

This clears the fault

Yes- Return to normal operation; **No-** Go to Step 6

6. Check the nip force of rollers N2, N3, N4 (PL 3.4). This can be done by:

- Do *GP 6.14 Idler Roller Inspection and Cleaning* to inspect the idler roller springs for these rollers.

- Do *GP 6.15 Drive Roller Inspection and Cleaning* to check the Drive Roller condition. Clean if necessary.
- Check the Paper path drive panel positions- see ADJ 1.8, Drive Panel Position Adjustment and perform adjustments if necessary.
- Check the Entrance Idler Panel position (PL 4.2)- see ADJ 1.7 Idler Panel Magnetic Latches Adjustment, perform adjustment as necessary.

This clears the fault

Yes- Return to normal operation; **No-** Escalate to second level

RAP 2.3 Jam Type C

Do the following if the lead edge is stopped past nip N5 to lead edge is stopped just before Steering rollers N6 and N7.

1. Check to see if there is any obstruction in the paper path.

Do RAP 2.8 Checking Obstruction in Paper Path – Area 3 (Acceleration Roller Idler)

This clears the fault

Yes- Return to normal operation; **No-** Go to Step 2

2. Check Sensors S1, S2, S3, S4, S5, S11, S12, S13, S14, S15, S16, S17, S18, S19, S20, S21, and S25.

- Do RAP 3.1 *Check Sensors S1, S2, S3, S4, S5, S22, S23, S24, S25, S26* and
- Do RAP 3.2 *Check Sensors S6 to S21*

This clears the fault

Yes- Return to normal operation; **No-** Go to Step 3

3. Do RAP 4.3 Check Solenoids SOL 3 to SOL 8 to check solenoids SOL3, SOL4 and SOL 5.

This clears the fault

Yes- Return to normal operation; **No-** Go to Step 4

4. Do RAP 5.1 Checking Stepper motors to check motors M1 and M2.

This clears the fault

Yes- Return to normal operation; **No-** Go to Step 5

5. Remove the Die Set and inspect the die throat. Make sure there is nothing restricting the flow of paper.

This clears the fault

Yes- Return to normal operation; **No-** Go to Step 6

6. Do RAP 2.8 Checking Obstruction in Paper Path – Area 4 (Punch Module).

This clears the fault

Yes- Return to normal operation; **No-** Go to Step 7

7. If the sheet is stopped by a die pin protruding through the die throat, do ADJ 1.5 to perform Punch Cam Indexing.

This clears the fault

Yes- Return to normal operation; **No-** Go to Step 8

8. When a sheet is jammed with the lead edge (or one of the corners in the lead edge) at a location where the die pins are, do the following:

- Open the front door.
- Look through the gap along the exit side of the die set. You will not be able to see the lead edge of the sheet. (One of the corners may be jammed in the die pin area, and the other corner may have advanced through the paper path).

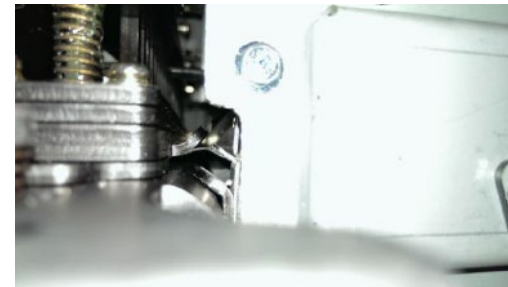

Unlock the die and look through the entrance side of the die set, you will be able to see the sheet.



- Unlatch the acceleration idler panel (PL 3.1) and Entrance Idler panel (PL 3.1) to see the trail edge of the sheet. (the trail edge of the sheet will be skewed if one of the corners is jammed as opposed to the whole lead edge being jammed)



This clears the fault

Yes- Return to normal operation; **No-** Go to Step 9

9. If there are multiple sheets jammed with the die pins partially through the sheet(s), do RAP 2.7 Multiple Sheets Jammed - Die Pins Partially Through the Sheets.

This clears the fault

Yes- Return to normal operation; **No-** Go to Step 10

10. Check the nip force of roller N5 (PL 3.4).

- Do *GP 6.16 Panel Latch Inspection* to inspect the Acceleration Idler Panel Latch (PL 3.5). If the Acceleration Idler Panel is not closed firmly, there will be insufficient nip force at N5.
- Do *GP 6.14 Idler Roller Inspection and Cleaning* to inspect the idler roller springs for these rollers Inspect Idler Roller Spring (PL 4.3).
- Do *GP 6.15 Drive Roller Inspection and Cleaning* to check the:
 - Drive Roller condition. Clean if necessary.
 - Check the Paper Path Drive Panel positions- see *ADJ 1.8, Drive Panel Position Adjustment* and perform adjustments if necessary.

This clears the fault

Yes- Return to normal operation; **No-** Escalate to second level

RAP 2.4 Jam Type D

Do the following if the lead edge of the first jammed sheet is past N6 and N7 but its trail edge is before or just past N6/N7

1. Check to see if there is any obstruction in the paper path.

This clears the fault

Yes- Return to normal operation; **No-** Go to Step 2

2. Do RAP 3.1 to check Sensors S3, S4, S5, S22, S23, S24, and S25.

This clears the fault

Yes- Return to normal operation; **No-** Go to Step 3

3. Do RAP 3.2 to check Sensors S6, S7, S8, S9, S10, S11, S12, S13, S14, S15, S16, S17, and S22.

This clears the fault

Yes- Return to normal operation; **No-** Go to Step 4

4. Do RAP 3.3 to check Sensor S28.

This clears the fault

Yes- Return to normal operation; **No-** Go to Step 5

5. Do RAP 4.3 to check Solenoids SOL3 to SOL8.

This clears the fault

Yes- Return to normal operation; **No-** Go to Step 6

6. Do RAP 5.1 to check Motors M1, M2, M3, M4, M5, M6 and M7.

This clears the fault

Yes- Return to normal operation; **No-** Go to Step 7

7. Do RAP 2.8 Checking Obstruction in Paper Path - Area 4 Punch Module.

This clears the fault

Yes- Return to normal operation; **No-** Go to Step 8

8. Do GP 6.15 Drive Roller and Steering Drive Roller Inspection and Cleaning, to Inspect and Clean Steering Drive Rollers

This clears the fault

Yes- Return to normal operation; **No-** Go to Step 9

9. Do GP 6.14.2 Steering Idler Roller and Springs Inspection and Cleaning.

This clears the fault

Yes- Return to normal operation; **No-** Go to Step 10

10. Inspect Punch Clutch Anti-Rotation Screw (M6 socket head screw) of the Punch clutch. If it is loose, tighten it. See REP 3.4 for details.

This clears the fault

Yes- Return to normal operation; **No-** Go to Step 11

11. Check the (2x) Cone Point Set Screws of the Punch Clutch. Tighten if loose, replace with new ones if missing. See REP 3.4 for details.

This clears the fault

Yes- Return to normal operation; **No-** Go to Step 12

12. Do GP 6.23 Alignment Carriage Rails Cleaning.

This clears the fault

Yes- Return to normal operation; **No-** Go to Step 13

13. Inspect the ground strap in the Steering Carriage Sub Assembly (PL 5.3). If continuity is missing, fasten it with the appropriate screw. If it is cut/damaged, replace the ground strap.

This clears the fault

Yes- Return to normal operation; **No-** Go to Step 14

14. Check if the machine is docked properly, GP 6.4.

This clears the fault

Yes- Return to normal operation; **No-** Go to Step 15

15. Inspect the Lower Exit Panel's magnetic latch (PL 3.2), See ADJ 1.7 Idler Panel Magnetic Latches Adjustment.

If the fault still exists, escalate to second level.

RAP 2.5 Jam Type E

Do the following if the first jammed sheet's trail edge is past N6 and N7

1. Check to see if there is any obstruction in the paper path from N8 to N11.

Do RAP 2.8 *Checking Obstruction in Paper Path*.

This clears the fault

Yes- Return to normal operation; **No-** Go to Step 2

2. Do RAP 3.1 to check Sensors S3, S4, S5, S22, S23, S24, and S25.

This clears the fault

Yes- Return to normal operation; **No-** Go to Step 3

3. Do RAP 3.2 to check Sensors S6, S7, S8, S9, S10, S11, S12, S13, S14, S15, S16, S17, S18, S19, S20, and S21.

This clears the fault

Yes- Return to normal operation; **No-** Go to Step 4

4. Do RAP 3.3 to check Sensor S28.

This clears the fault

Yes- Return to normal operation; **No-** Go to Step 5

5. Do RAP 4.3 to check Solenoids SOL3 to SOL8.

This clears the fault

Yes- Return to normal operation; **No-** Go to Step 6

6. Do RAP 5.1 to check Motors M6, M7, and M8.

This clears the fault

Yes- Return to normal operation; **No-** Go to Step 7

7. Check the nip forces of roller N8, N9, and N10. This can be done by:
(same as Jam type B)

- Do *GP 6.14 Idler Roller Inspection and Cleaning* to inspect the idler roller springs for these rollers (PL 4.4).
- Do *GP 6.15 Drive Roller Inspection and Cleaning* to check the Drive Roller condition. Clean if necessary.

- Check the Paper path drive panel positions - do ADJ 1.8 *Drive Panel Position Adjustment* and perform adjustments if necessary.
- Check the Exit Idler Panel position (PL 3.1) - See ADJ 1.7 *Idler Panel Magnetic Latches Adjustment*. Perform adjustment if necessary

This clears the fault

Yes- Return to normal operation; **No-** Escalate to second level

RAP 2.6 Jam Type F

Do the following if there is any obstruction in the paper path in the bypass section.

1. Check is there is any obstruction in the paper path in the bypass section.

Do RAP 2.1 *Jam Type A*.

This clears the fault

Yes- Return to normal operation; **No-** Go to Step 2

2. Do RAP 3.1 *Check Sensors S1, S2, S3, S4, S5, S22, S23, S24, S25, S26*.

This clears the fault

Yes- Return to normal operation; **No-** Go to Step 3

3. Do RAP 5.1 *Checking Stepper Motors* to check Bypass Motor M8 (PL 3.6).

This clears the fault

Yes- Return to normal operation; **No-** Go to Step 4

4. Check the Diverter mechanism (PL 3.3, L 3.8), do RAP 5.1.

This clears the fault

Yes- Return to normal operation; **No-** Go to Step 5

5. Check the nip force of rollers N1, N11, N12, N13, N14 (PL 3.1, PL 3.4). This can be done by:

- Do GP 6.14 *Idler Roller Inspection and Cleaning* to inspect the idler roller springs for these rollers (PL 4.5).
- Do GP 6.15 *Drive Roller Inspection and Cleaning* to check the Drive Roller condition. Clean if necessary.
- Check the Paper path drive panel positions- see ADJ 1.8, and perform adjustments if necessary.
- Check the Exit Idler Panel position (PL 3.2)- see ADJ 1.7 *Idler panel Magnetic Latches adjustments*, perform adjustment is necessary.

This clears the fault

Yes- Return to normal operation; **No-** Escalate to second level

RAP 2.7 Multiple Sheets Jammed - Die Pins Partially Through the Sheets

Use this RAP if there are multiple sheets jammed with the die pins partially through the sheets.

1. Using the Caster adjustment wrench found inside the front door, Crank the punch shaft in the clock-wise direction (when viewed from the front of the machine) using the flats in the front of the machine.

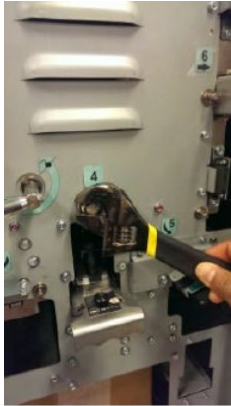

Flats are also present in the back side of the shaft which can be accessed by removing the rear cover.

2. Remove the jammed sheets.
3. If it is too difficult to crank the punch shaft:
 - Remove rear cover.
 - Disconnect the clutch wires at the Clutch Solenoid (PL 5.1, PL 5.6).
 - Remove two screws that hold the Clutch Stud bracket.

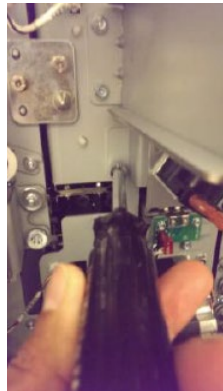

- Rotate the Clutch along with the shaft in the opposite direction (clockwise direction when viewed from the back) until the pins exit the sheet.



- Remove the jammed sheets.
- Return the Clutch Bracket and the Clutch to their positions and install the Screws.
- Connect the clutch wires at the Clutch Solenoid (PL 5.1, PL 5.6).
- Confirm the punch cycles correctly by entering the Service User Interface, GP 6.2, and running Cycle Punch Function Test, GP 6.2.12 to verify the punch cam returns to home position. If it does not, perform Punch Cam Indexing, ADJ 1.5.

RAP 2.8 Checking Obstruction in Paper Path

Use this RAP to checking for an obstruction in the paper path.

When inspecting for obstruction to paper path, look for any ripped pieces of paper or any other objects like loose fasteners along the paper path. A few key areas to inspect are shown below:

Area 1 (Entrance)

1. Open the Front Door.
2. Open the Bypass Panel.
3. Inspect the gap between the Drive Roller and the sheet metal panel for any objects.



Area 2 (Entrance Idler Panel Assembly)

1. At the top of Area 2 (Entrance Idler Panel Assembly), check if there is a 2 to 3mm gap for sheet flow.



2. If the Lower entrance panel (PL 3.1) is bent, replace it (REP 2.1)

Area 3 (Acceleration Roller Idler)

1. Inspect for any object wedged between the roller and sheet metal window.



Area 4 (Punch Module)

1. Remove the Die Set and inspect at the following locations.
2. Check the Guide Brackets immediately upstream and downstream of the Die Set.

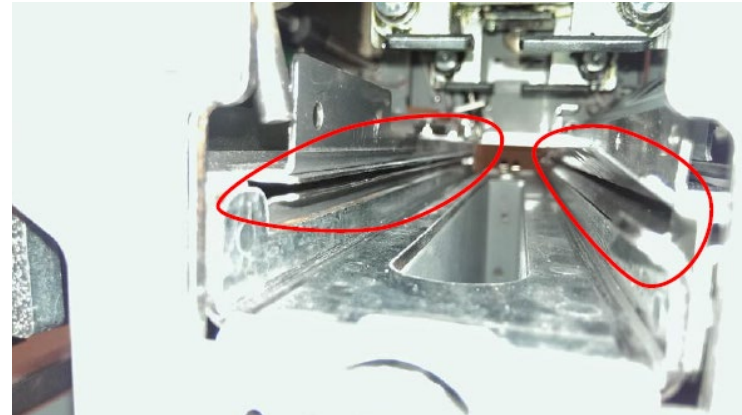

3. Remove the M4 Nuts (3) and the cover for Area 5.



4. Inspect the paper path for any obstructions closely.
(Cont.)

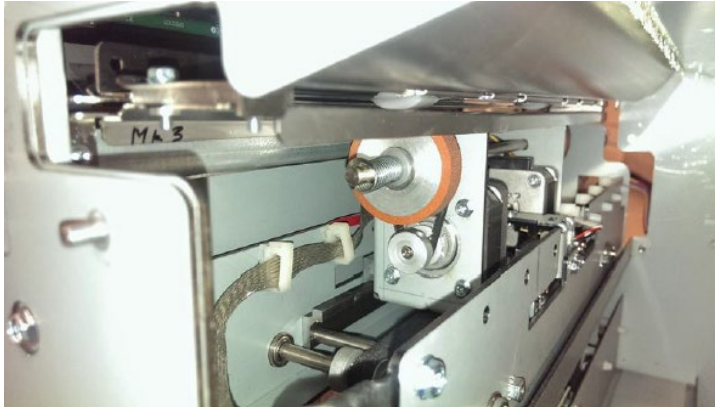

5. Check that the Drive panel and the Idler Panel of the Steering module subassembly (PL 5.4 and PL 5.5) are centered to the guide brackets as shown.



If one of the below panels is bent, replace

- Steering idler panel weldment- PL 5.4; REP 3.10
- Steering drive panel weldment- PL 5.5; REP 3.12

RAP 2.9 PAPER JAM J431

Important Note: Double Punch is available only for DFA configurations.

When Double Punch is selected from the FuturoPunch Pro LCD, and a sheet that cannot be “Double punched” is processed through the printer, FuturoPunch Pro will stop and display message J431.

RAP 2.10 PAPER JAM J432

Use this RAP if the machine stops and PAPER JAM J432 message is shown on the LCD.

FuturoPunch Pro can process sheets that are fed +/- 10mm from the center. If the sheets are offset more than a specified distance from the center, Alignment Fail Safe Stop will be reached. To troubleshoot this condition, do the following:

1. *For DFA configurations only- Check if the line speed is set correctly GP 6.2.2*
For all OEM configurations, go to Step 2
Line speed is set correctly
Yes- Go to Step 2; **No-** correct it and resume normal operation
2. Do RAP 3.1, Check Sensors S1, S2, S3, S4, S5, S22, S23, S24, S25, S26 to check Sensor S1, S11, S12, S13, S14 and S15
This clear the fault
Yes- Resume normal operation; **No-** Go to Step 3
3. Check if the Upstream docking bracket is centered. See Section 8.6.1
Upstream docking bracket is installed correctly
Yes- Go to Step 4; **No-** Install correct and resume normal operation
4. Check the DIP switch settings for Motor Driver DRV M5.
See REP 2.26, Motor Driver (Stepper Board) Replacement for details.
DIP switch for DRV M5 is set correctly
Yes- Escalate to second level;
No- Correct the DIP switch and resume normal operation.

RAP 2.11 PAPER JAM J433

Use this RAP if the machine stops and PAPER JAM J433 message is displayed.

If the skew of the sheets fed into FuturoPunch Pro exceeds the maximum value, FuturoPunch Pro stops and displays PAPER JAM J433. To troubleshoot this condition, do the following:

1. Inspect the docking pins in the upstream side- Section 8- 8.8.

Machine is properly docked

Yes- Go to Step 2

No- Correct the docking and resume normal operation

2. Do RAP 3.2 to check Sensors S6 to 10.

This clears the fault

Yes- Resume normal operation; **No-** Go to Step 3

3. Do RAP 3.3 to check Sensor S28.

This clears the fault

Yes- Resume normal operation; **No-** Go to Step 4

4. Check/ correct skew from upstream device if necessary.

This clears the fault

Yes- Resume normal operation; **No-** Escalate to second level

3 SENSOR CHECKS

RAP 3.1 Check Sensors S1, S2, S3, S4, S5, S22, S23, S24, S25, S26

Use this RAP to check sensors S1, S2, S3, S4, S5, S22, S23, S24, S25, S26.

1. Ensure that the front door is properly closed. Interrupted interlock connection can trigger sensor paper jam codes.
2. Do GP 6.2.7 *SENSORS Procedure*. Check to make sure all sensors should show “0” on the LCD when uncovered and “1” when covered. If any sensor shows “1” when uncovered, clean that sensor. Also check is there us any obstacle in the sensor window.

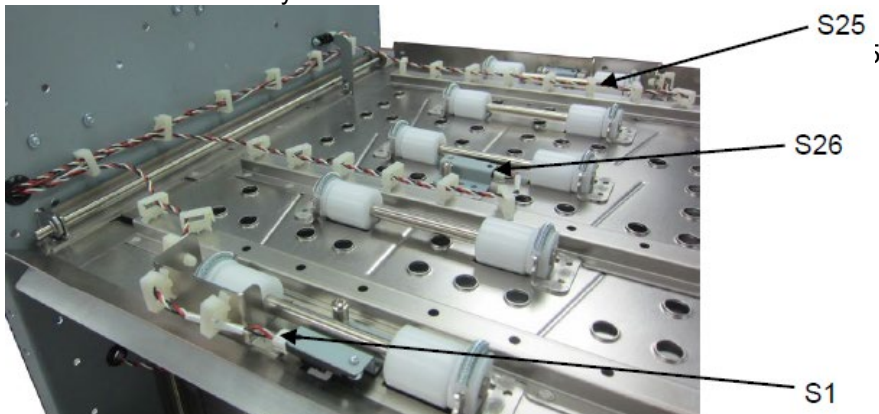

Sensors S1, S25, and S26 are on the Upper Bypass Panel (PL 4.5).

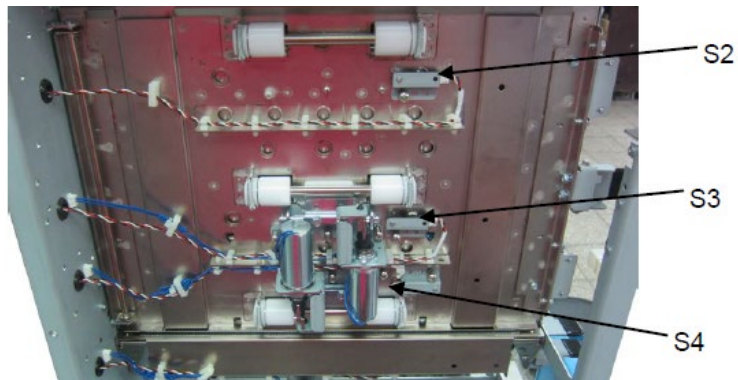

Sensors S2, S3, and S4 are on the Entrance Idler Panel (PL 4.2).

Sensor S5 is on the Acceleration Roller Idler (PL 4.3)

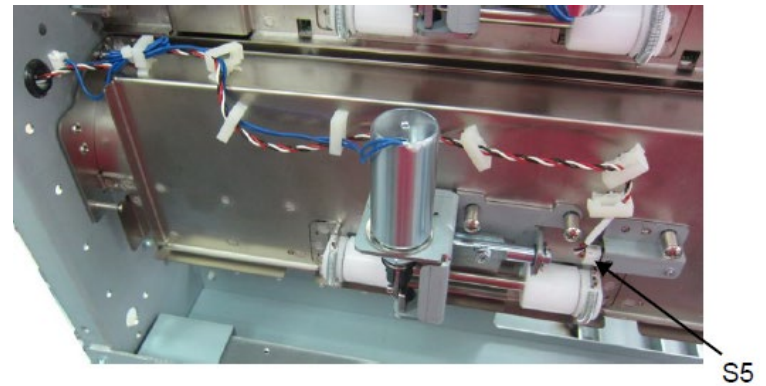

Sensor S22, 23 and 24 are on the Exit Idler panel (PL 4.4)

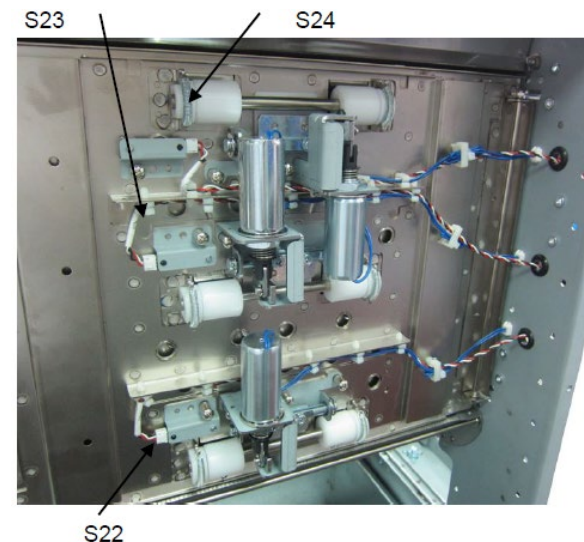

All sensors show “0” when uncovered and “1” when covered

Yes- Return to the RAP that directed you here.

No- Go to Step 2

2. Make sure the sensor wire is connected securely at the Sensor and at the Main Control Board (PL 7.1). Do REP 1.6 to remove the Rear Cover to gain access to the connector at the Control Board.

See the *Sensor Cables* table in Section 7 Wiring
See REP 2.25 for details on connection at the sensor(s)

All the connections are made securely

Yes- Go to Step 3

No- Make the connection and return to normal operation.

3. Replace the Sensor with a new one (alternatively, swap the sensor in the faulty position with a sensor from a different good position to check if it is a bad sensor). See REP 2.25 for Sensor replacement.
 - Do GP 6.3 to Undock the FuturoPunch Pro
 - Do REP 1.8 to remove the Upstream Side Frame Cover or do REP 1.11 to remove the Downstream Side Frame Cover

Replacing the sensor corrects the issue

Yes- Use the new sensor and return to normal operation

No- Go to Step 4

4. Do GP 6.3 to Undock the FuturoPunch Pro and visually inspect the Cable from the sensor all the way to the Control Board (PL 7.1). If the Cable is damaged, replace the Cable.

See the *Sensor Cables* table in Section 7 Wiring

Sensor cable looks okay

Yes- Go to Step 5

No- Go to Step 6

5. Do GP 6.2.16 FIRMWARE UPGRADE Procedure to Re-flash the firmware for the FuturoPunch Pro.

Re-flashing firmware clears the fault

Yes- Resume normal operation; **No-** Go to Step 6

6. Replace the Sensor Cable.
 - Do GP 6.4 to Undock the FuturoPunch Pro.
 - Remove the faulty cable from the sensor by releasing the required cable clamps.
 - Replace with a new cable.

See the *Sensor Cables* table in Section 7 Wiring

Replacing the sensor cable corrects the issue

Yes- Resume normal operation; **No-** Go to Step 7

7. Do REP 5.1 to replace the Main Control Board (PL 7.1).

This clears the fault

Yes- Resume normal operation; **No-** Escalate to second level

Sensor
Cables

Sensor	Description	Cable #	Header	Interim Cable #	Control Board Connector	
S1	Entrance Sensor, S1	023N01343	-	-	J21	Shares cable with S25, S26
S2	Entrance Sensor, Top	023N1346	-	-	J22	Shares cable S3, S4, S5
S3	Entrance Sensor, Middle	023N1346	-	-	J22	Shares cable S2, S4, S5
S4	Entrance Sensor, Bottom	023N1346	-	-	J22	Shares cable S2, S3, S5
S5	Accel Sensor	023N1346	-	-	J22	Shares cable S2, S3, S4
S6	Skew Sensor Board	023N01350	Header	023N01349	J23	
S7	Skew Sensor Board	023N01350	Header	023N01349	J23	
S8	Skew Sensor Board	023N01350	Header	023N01349	J23	
S9	Skew Sensor Board	023N01350	Header	023N01349	J23	
S10	Skew Sensor Board	023N01350	Header	023N01349	J23	
S11	Alignment Sensor Board	023N01325	Header	023N01344	J24	
S12	Alignment Sensor Board	023N01325	Header	023N01344	J24	
S13	Alignment Sensor Board	023N01325	Header	023N01344	J24	
S14	Alignment Sensor Board	023N01325	Header	023N01344	J24	
S15	Alignment Sensor Board	023N01325	Header	023N01344	J24	
S16	Trail Edge BG Sensor Board	023N01326	Header	023N01345	J25	Shares cable with S28
S17	Trail Edge BG Sensor Board	023N01326	Header	023N01345	J25	Shares cable with S28
S18	Large Mid Punch Sensor Bd	023N01348	-	-	J26	Shares cable with S20/S21
S19	Large Mid Punch Sensor Bd	023N01348	-	-	J26	Shares cable with S20/S21
S20	X-Large Mid Punch Sensor Bd	023N01348	-	-	J26	Shares cable with S18/S19
S21	X-Large Mid Punch Sensor Bd	023N01348	-	-	J26	Shares cable with S18/S19
S22	Exit Sensor, Bottom	023N01347	-	-	J28	Shares cable with S23, S24
S23	Exit Sensor, Middle	023N01347	-	-	J28	Shares cable with S22, S24
S24	Exit Sensor, Top	023N01347	-	-	J28	Shares cable with S22, S23
S25	Exit Sensor	023N01343	-	-	J21	Shares cable with S1, S26
S26	Bypass Sensor, Middle	023N01343	-	-	J21	Shares cable with S1, S25
S27	Bypass Open Sensor	023N01342	-	-	J30	
S28	Align Home Sensor	023N01324	Header	023N01345	J25	Shares cable with S16/S17
S29	Chip Level Sensor - Emitter/Receiver	023N01327	-	-	J27	
S1B	Clear Cover Sensor – Emitter/Receiver	023N01355	-	-	J29	

RAP 3.2 Check Sensors S6 to S21

Use this RAP to check Sensors S6 to S21.

Sensors S6, S7, S8, S9, S10

To Access Sensors S6, S7, S8, S9, S10

- Undock FuturoPunch Pro- This step is optional- if possible reach in through the jam access opening without undocking the punch.
- Open Front Door.
- Open Lower Exit Panel Assembly.

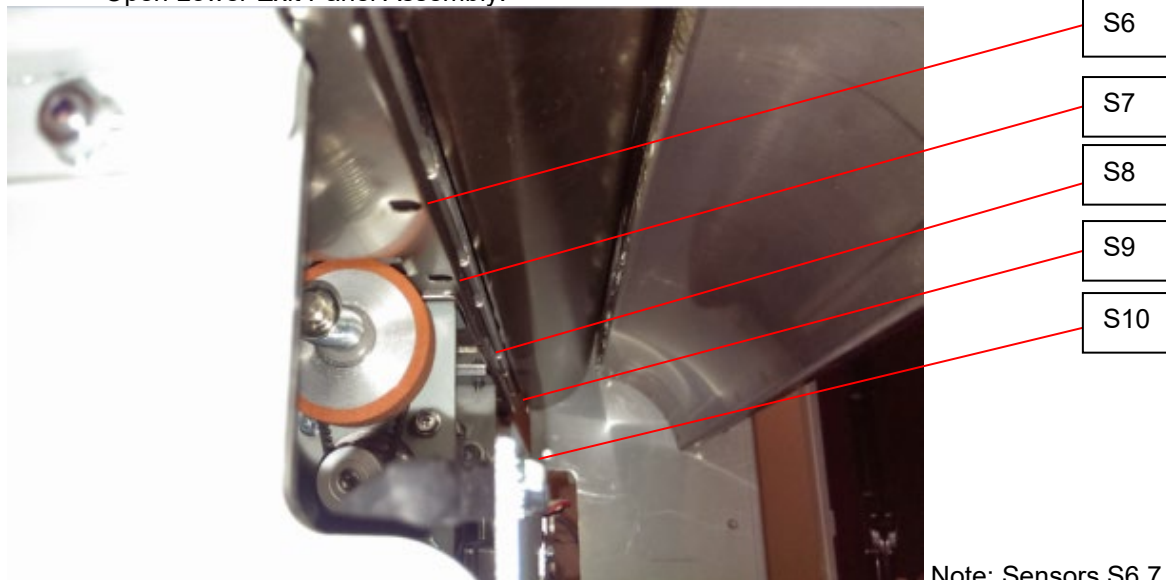

Note: Sensors S6,7,8,9 and 10 are on the Skew Sensor Board

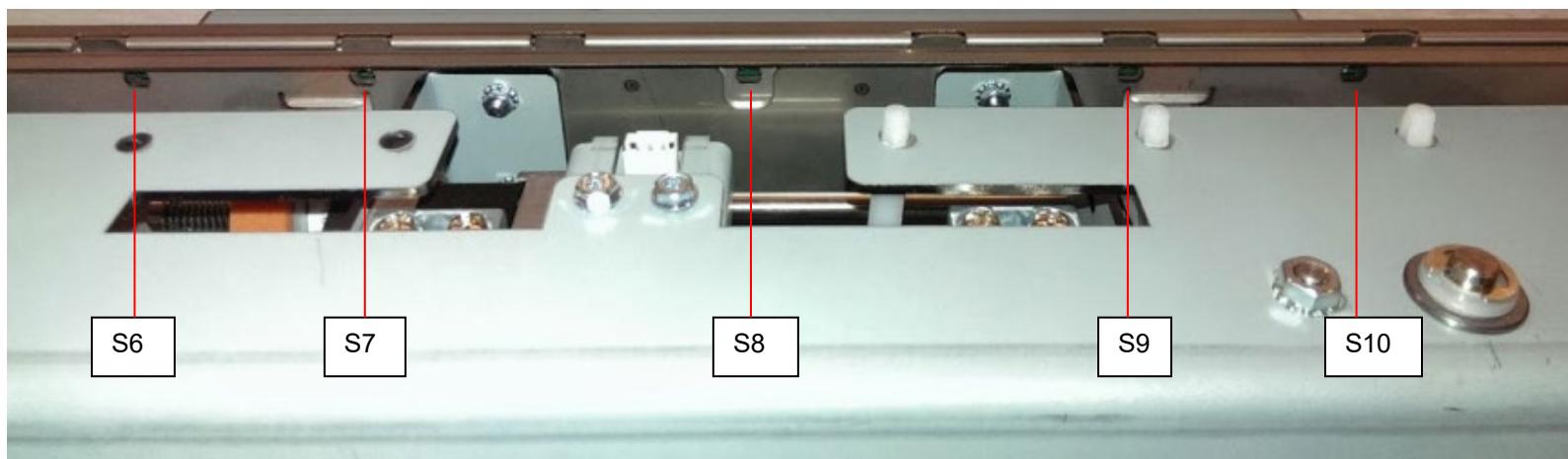

Sensors S11, S12, S13, S14 and S15

To Access Sensors S11, S12, S13, S14 and S15

- Undock FuturoPunch Pro- This step is optional- if possible reach in through the jam access opening without undocking the punch.
- Locate the Alignment Sensor Board

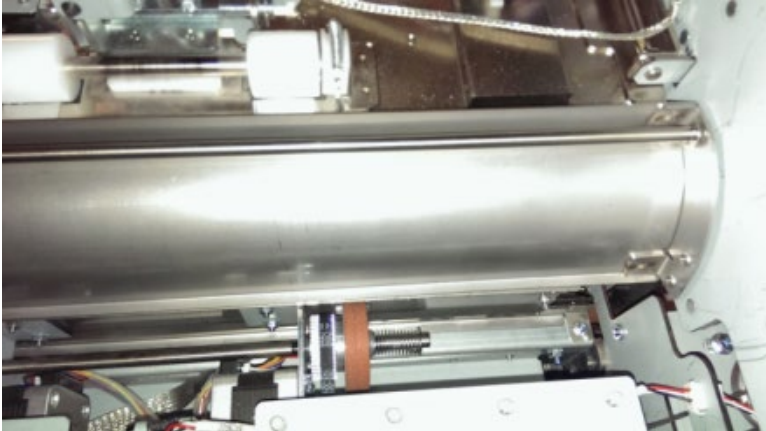

Sensors S11, 12, 13, 14 and 15 are on the Alignment Sensor Board

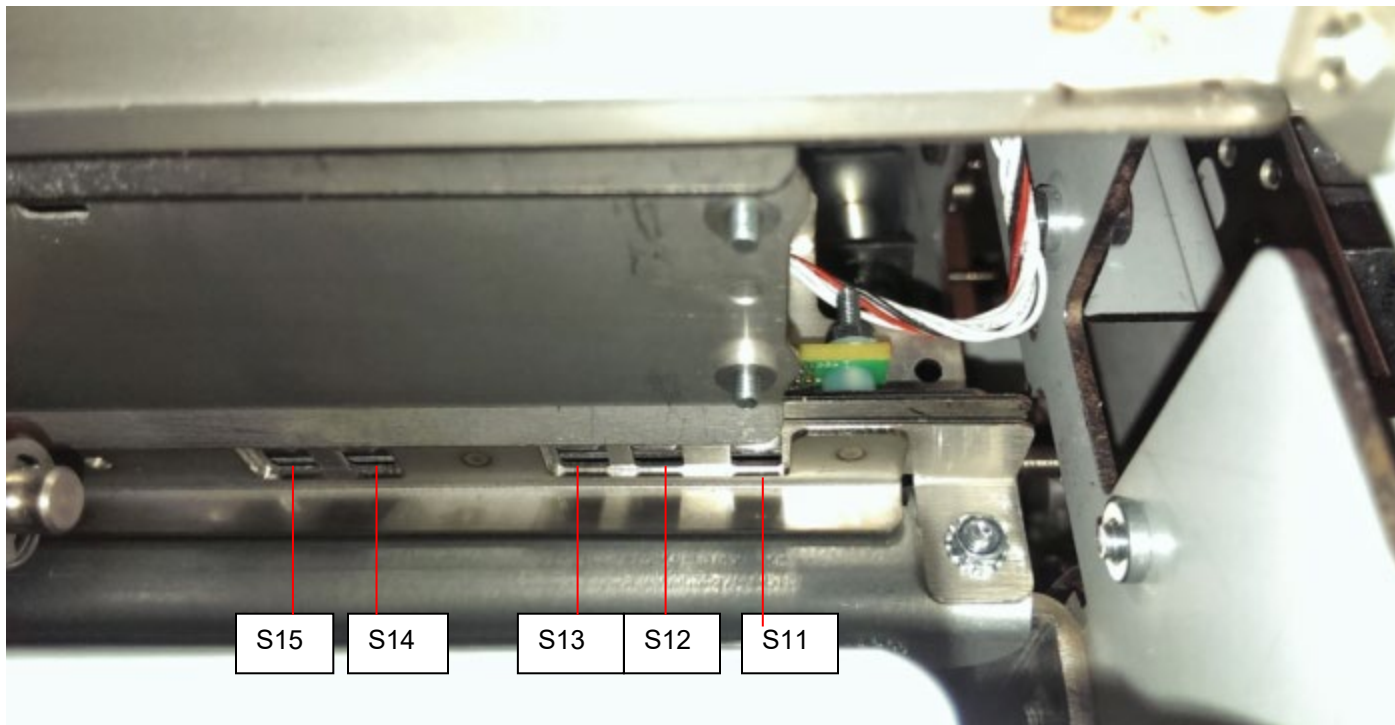

Sensors S16 and S17

To Access Sensors S16 and S17:

- Open the Front Door.
- Unlatch and open the Acceleration Idler Panel.



Sensors S16 and S17 are on Backgage Sensor Board.

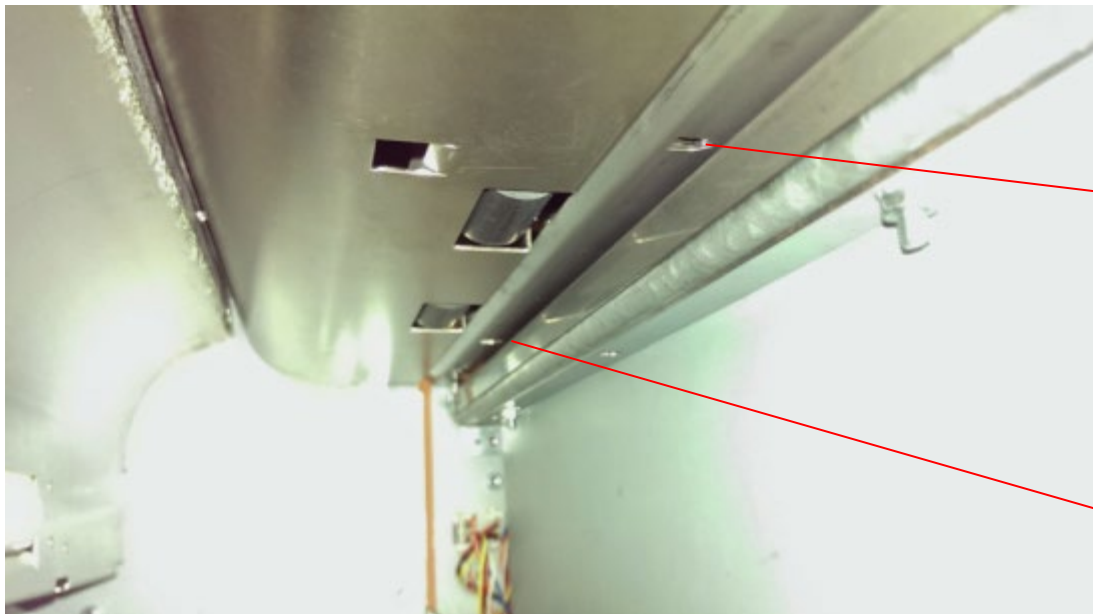

S16

S17

Sensors S18, S19, S20 and S21

To Access Sensors S18, S19, S20 and S21:

- Open the Front Door.
- Unlatch and open the Entrance Idler Panel.

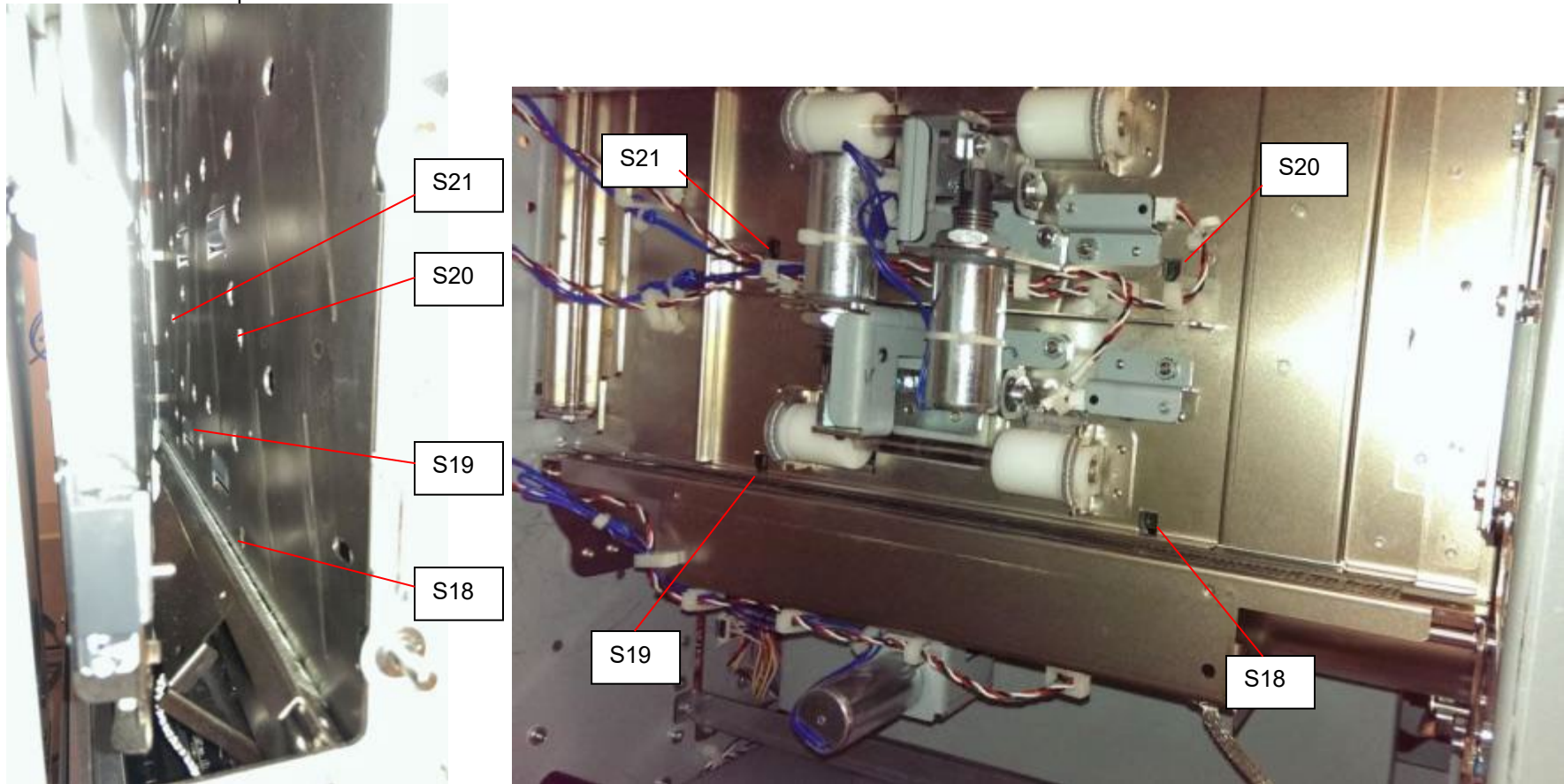

Sensors S18 and S19 are on Mid Punch Large Backgag Sensor Board.

Sensors S20 and S21 are on Mid Punch XL Backgag Sensor Board.

Procedure

1. Do GP 6.2.7 *SENSORS Procedure*. Check to make sure all sensors should show “0” on the LCD when uncovered and “1” when covered.

If any sensor shows “1” when uncovered, clean that sensor. Also check if there is any obstacle in the sensor window.

All sensors show “0” when uncovered and “1” when covered

Yes- Return to the RAP that directed you here.

No- Go to Step 2

2. Check the connections to the faulty sensor(s).

See the *Sensor Cables* table in Section 7 Wiring

- Remove Rear cover- REP 1.6. Check the connection at the header in the Punch frame and the Main Control Board. See REP 3.1 for the location of the Connector.
- Remove the Punch module- REP 3.1.1. Check the connection from the sensor board to the header in the punch frame. S18 to 21 do not have headers, so inspect the connection at Sensor Board and Main Control Board (PL 7.1).

All the connections are made securely

Yes- Go to Step 3

No- Make the connection and return to normal operation.

3. Light from sensor components can be viewed with a cell phone camera, if the sensor is working you will be able to see a bright light. Alternately a small mirror can be used.

CAUTION: Sensor emits High Intensity narrow angle Infrared beam (940nm). It is invisible to naked eye, avoid looking directly at the sensor when the machine is powered ON. See Section 0, page ix for other languages.

- a) If there is no light from any sensor on that particular board (S6-S10; S11-S15; S16-17; S18-19; S20-21),
 - Replace cable. Replace the Cable from the Sensor Board to the Punch Frame first. If that does not solve the issue, replace cable from frame to Main Control Board. See the *Sensor Cables* table in Section 7 Wiring
 - Replace the faulty Sensor Board (REP 2.25)
- b) On the same board- If there is light from one sensor and there is no light from another sensor:

- Replace the faulty Sensor Board (REP 2.25).
- Replace Sensor Cable. Replace the Sensor Cable from the Sensor Board to Punch Frame first. If that does not solve the issue, replace the Sensor Cable from the frame to Main Control Board. See the *Sensor Cables* table in Section 7 Wiring

There is a bright light from all the sensors

Yes- Go to Step 4;

No- Replace the faulty component and resume normal operation

4. Replace the faulty sensor board- REP 2.25

This clears the fault

Yes- Resume normal operation

No- Go to Step 5

5. Replace the faulty sensor cable

See the *Sensor Cables* table in Section 7 Wiring

This clears the fault

Yes- Resume normal operation

No- Go to Step 6

6. Do GP 6.2.16 FIRMWARE UPGRADE Procedure to Re-flash the firmware for the FuturoPunch Pro.

This clears the fault

Yes- Resume normal operation

No- Go to Step 7

7. Do REP 5.1 to replace the Main Control Board (PL 7.1).

This clears the fault

Yes- Resume normal operation

No- Escalate to second level

RAP 3.3 Checking Sensor S28 Align Home Sensor

Location

To Access Sensor S28:

- Open the Front Door.
- To uncover this sensor, slide the Alignment carriage (PL 5.3) towards the front of the machine. The Alignment carriage can be located in the Jam access window near Zone 5.
- To cover this sensor, slide the Alignment carriage (PL 5.3) towards the rear of the machine. The Alignment carriage can be located in the Jam access window near Zone 5.

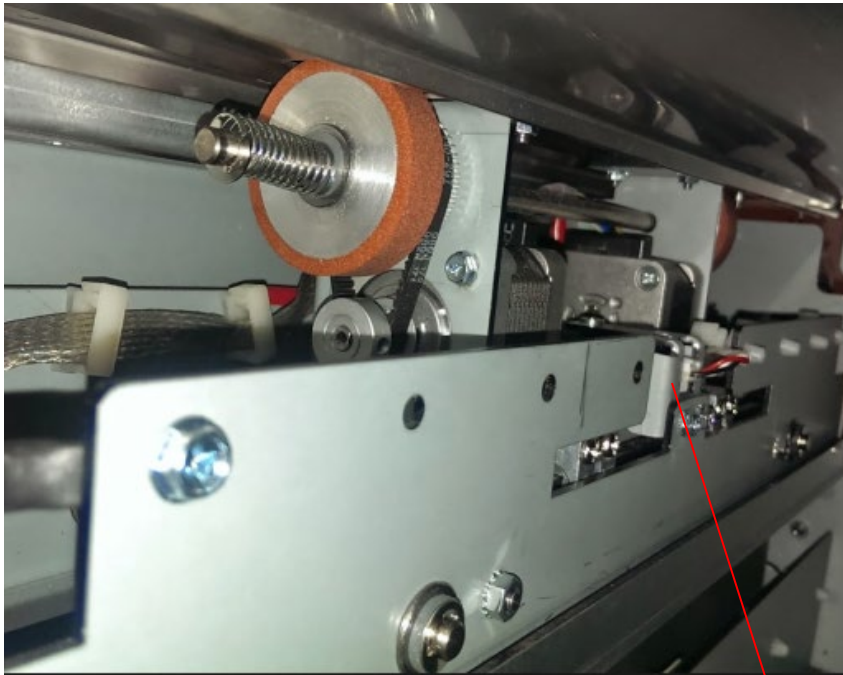

S28

Procedure

1. Do GP 6.2.7 *SENSORS Procedure* to make sure the sensor shows “1” on the LCD when the Alignment carriage flag blocks the sensor and “0” when the Alignment carriage flag unblocks the sensor.

LCD shows “0” when unblocked and “1” when blocked

Yes- Return to the RAP that directed you here.

No- Go to Step 2

2. Make sure the sensor wire is connected securely at the header in the punch module frame and the main control board
See the *Sensor Cables* table in Section 7 Wiring
See REP 3.1 for the location of the Connector.

Connection is secure at the punch frame and Control board.

Yes- Go to Step 3;

No- Make the connection and resume normal operation

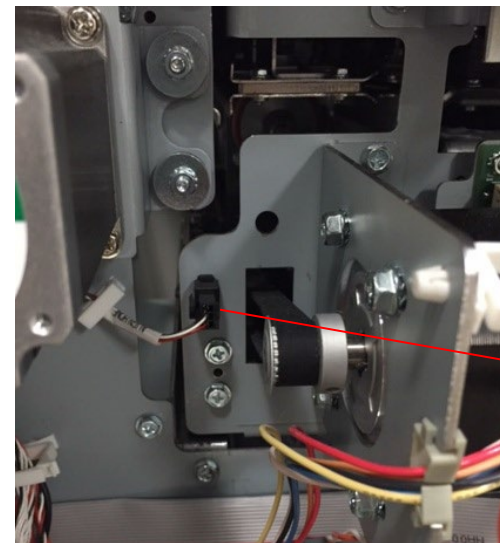

S28 header

3. With the front door open, check if the sensor wire is connected securely at the sensor and the punch module frame on the inside.

Connection is secure at both ends

Yes- Go to Step 4;

No- Make the connection and resume normal operation

4. Replace the Align Home Sensor REP 2.25.4

This clears the fault

Yes- Resume normal operation; **No-** Go to Step 5

5. Visually inspect the Sensor cable 023N01324 from Sensor to Punch frame header; 023N01345 Punch frame header to Control board. (see Section 7 Wiring), To closely inspect the sensor cable from sensor to header, it is recommended to undock the punch.

Cable appears to be damaged

Yes- go to Step 7 or 8; **No-** Go to Step 6

6. Do GP 6.2.16 FIRMWARE UPGRADE Procedure to Re-flash the firmware for the FuturoPunch Pro.

This clears the fault

Yes- Resume normal operation; **No-** Go to Step 7

7. Replace the Sensor Cable from Align Home Sensor to header. PL 7.3, see Section 7 Wiring

This clears the fault

Yes- Resume normal operation; **No-** Go to Step 8

8. Replace the cable from header to Main control board, PL 7.3, see Section 7 Wiring

This clears the fault

Yes- Resume normal operation; **No-** Go to Step 9

9. Do REP 5.1 to replace the Main Control Board (PL 7.1).

This clears the fault

Yes- Resume normal operation

No- Escalate to second level

4 SOLENOID CHECKS

RAP 4.1 Check Solenoid SOL 1

Solenoid SOL1 is the diverter solenoid- mechanical adjustment is covered in detail in ADJ 1.2 Diverter Solenoid Adjustment.

1. Open the front the door and insert an Interlock Cheater into the Punch Door interlock Switch SW4 (PL 2.2).

WARNING

Moving Parts, keep hands clear of nips and the belts when the Interlock Cheater is inserted. See Section 0, page vii for other languages.

2. Do GP 6.2.10 *SOLENOIDS Procedure* to activate and deactivate Solenoid SOL1.

The diverter gate should rise and fall when SOL1 is cycled.

Diverter gate rises and falls when SOL1 is cycled

Yes- Return to the RAP that directed you here

No- Go to Step 3 and choose the appropriate condition

3. If SOL1 does not function, do the below steps:
 - Do REP 1.6 to remove the Rear Cover.
 - Check the cable from the solenoid to the in-line header. This cable is part of the solenoid body.
 - Check the cable 023N01351 (see Section 7 Wiring) that connects the in-line header to the Main Control Board.
 - Replace the SOL1 (REP 2.28.1) or 023N01351 (PL 7.3), as needed.

If SOL1 functions, do the below steps:

- Go to ADJ 1.2 and perform adjustment if necessary.

This clears the fault

Yes- Return to normal operation **No-** Go to Step 4

4. Do GP 6.2.16 *FIRMWARE UPGRADE Procedure* to Re-flash the firmware for the FuturoPunch Pro.

This clears the fault

Yes- Return to normal operation; **No-** Go to Step 5

5. Do REP 2.28.1 Diverter Solenoid Replacement.

This clears the fault

Yes- Return to normal operation; **No-** Go to Step 6

6. Do REP 7.1 Main Control Board Replacement.

This clears the fault

Yes- Return to normal operation; **No-** Escalate to second level

RAP 4.2 Check Solenoid SOL 2

Solenoid SOL 2 is the Punch Clutch, see:

- RAP 2.4 Jam Type D.
- RAP 2.7 Multiple Sheets Jammed - Die Pins Partially Through the Sheets.

RAP 4.3 Check Solenoids SOL 3 to SOL 8

Use this RAP to check Solenoids SOL3, SOL4, SOL5, SOL6, SOL7, and SOL8.

1. Open the front the door and insert an Interlock Cheater into the Punch Door interlock Switch SW4 (PL 2.2).

WARNING

Moving Parts, keep hands clear of nips and the belts when the Interlock Cheater is inserted. See Section 0, page vii for other languages.

2. Do GP 6.2.10 SOLENOIDS Procedure to activate and deactivate the affected solenoid.

When the solenoid is not activated, the idler roller should be able to rotate freely, and in turn drive the drive roller.



not activated



fully activated

When the solenoid is fully activated, the idler roller should completely lift off and not be able to drive the drive roller.

NOTE: Disengaging solenoid modules need to be replaced every 5 million cycles.

To check the holding force of the solenoid, go to Step 3

If the solenoid does not actuate, go to Step 4

Alternate solenoid inspection method:

Mark a line on the idler roller shaft as shown in the picture.

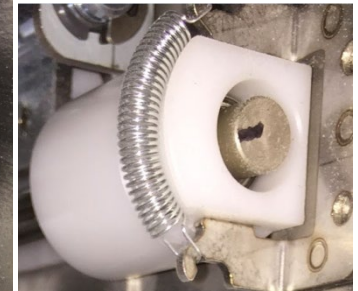

Motor running + Solenoid actuated = Line not visible

Motor running + Solenoid not actuated = Line visible

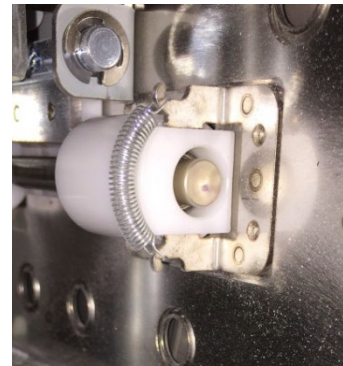

Picture shows Motor running and solenoid actuated.

From the service mode solenoid can be actuated using GP 6.2.10 Solenoids Procedure, and the corresponding drive roller rotated manually to check this.

3. Do the following to check the holding force of the Solenoid:
 - Activate a good solenoid and the solenoid in question (bad solenoid).
 - Try to push the plunger of the solenoid away from the body of the solenoid. Both solenoids should have approximately the same holding force. If the bad solenoid's Holding force is low, do REP 2.28 Solenoid Replacement to replace the Solenoid (PL 4.6).

This clears the fault

Yes- Return to normal operation; **No-** Go to Step 6

4. If the solenoid does not activate at all, inspect the cables from solenoid to header to control board. (PL 4.2, PL 4.3 and PL 4.4)

The solenoid cables look okay

Yes- Go to Step 5; **No-** Replace the faulty solenoid module REP 2.28

5. Do REP 2.28 Solenoid Replacement to replace the faulty Solenoid (PL 4.6).

This clears the fault

Yes- Return to normal operation; **No-** Go to Step 6

6. Do GP 6.2.16 FIRMWARE UPGRADE Procedure to Re-flash the firmware for the FuturoPunch Pro.

This clears the fault

Yes- Return to normal operation; **No-** Go to Step 7

7. Replace the cable from header to the main control for the solenoid in question. 023N01351 or 023N01352, PL 7.3, see Section 7 Wiring

This clears the fault

Yes- Return to normal operation; **No-** Go to Step 8

8. Do REP 5.1 to replace the Main Control Board (PL 7.1).

This clears the fault

Yes- Return to normal operation; **No-** Escalate to second level

5 MOTOR CHECKS

RAP 5.1 Checking Stepper Motors

Use this RAP to check Stepper Motors.

1. Open the front the door and insert an Interlock Cheater into the Punch Door interlock Switch SW4 (PL 2.2).

WARNING

Moving Parts, keep hands clear of nips and the belts when the Interlock Cheater is inserted. See Section 0, page vii for other languages.

2. For motors M1, M2, M3, M4, M6, M7, and M8; do *GP 6.2.11 Motors Procedure* to check that the corresponding nip rollers turn (check Drive and idler Rollers, see PL 3.6 for the identifying the motors.

For Motor M5, do *GP 6.2.12 FUNCTION TESTS Procedure* (Aligner Test).

The table below identifies the nip rollers driven by the corresponding motors:

Motor	Nip rollers
M1	N2, N3 and N4
M2	N5
M3	N6- Front side steering roller
M4	N7- Rear side steering roller
M5	Alignment Carriage
M6	N8, N9
M7	N10
M8	N1, N11, N12, N13, N14

3. Do REP 1.6 to remove the Rear Cover.
4. If you are troubleshooting M3 or M4 or M5, do the below step, for other motors directly go to Step 5.
All the below connections are explained in detail in REP3.1 Punch module Removal/Installation.
M3- Make sure the connector for M3 is inserted into the header at the back of the punch module.

M4- Make sure the connector for M3 is inserted into the header at the back of the punch module.

M5- Make sure the connector from M5 stepper motor is inserted into the driver board for motor M5.

All the connectors are securely connected.

Yes- Go to Step 5; **No-** Make the connection and resume operation

5. For the motor in question, make sure three connectors at the Stepper Driver board (J1, J2 and J3) and two connectors at the Main Control Board are inserted firmly (see Section 7 Wiring)

J17 and J16 for M3, M4 and M5

J17 and J15 for M6, M7 and M8

J17 and J14 for M1 and M2

All the connectors are securely connected.

Yes- Go to Step 5; **No-** Make the connection and resume operation

6. Inspect the timing belt for the correspond motor drive- *GP 6.21 Timing Belt Inspection*. Follow the procedure to inspect the belts and replace if necessary (REP 2.21).

Note: If the timing belt of motor M5 is damaged (PL 5.2), do REP 3.7 to replace the entire Alignment Carriage Sub Assembly (PL 5.3).

For M5 Alignment Stepper Motor- Inspect the open ended belt in Alignment carriage Sub assembly (PL 5.3). If it is damaged, replace the Alignment Carriage sub assembly (REP 3.7)

All timing belts are okay

Yes- Go to Step 6; **No-** Replace the faulty belt and resume operation

7. Check the tightness of the set screw of pulleys on the stepper motor shaft (Stepper and Mount assembly PL 3.6). Also check the set screws/ coiled spring pins for all the pulleys (PL 5.3) that are driven by the stepper motor in question.

All the set screws are secured tightly

Yes- Go to Step 7;

No- Tighten the loose set screw and resume operation

8. For the motor in question, check the DIP switch settings for the corresponding Driver Board (see REP 2.26).

All the DIP switch setting are correct

Yes- Go to Step 8; **No-** Correct the DIP switch and resume operation.

9. Check if there is power to the Driver board. LED 1 on the Driver board should be lit.

If LED 1 is lit, it means there is 24V DC power to the Driver board from the Main Control board.

If LED 2 is lit, it means there is a fault with either the Driver board or the stepper motor.

Continue to Step 9

10. Check the cable connecting the stepper motor to the Driver Board (hard-wired to motor); and two cables connecting driver board to Main Control Board (see Section 7 Wiring)

023N01339 and 023N01323 for M3, M4 and M5

023N01339 and 023N01324 for M6, M7 and M8

023N01339 and 023N01333 for M1 and M2

The cables look okay

Yes- Go to Step 10;

No- Replace the faulty cable and resume normal operation

11. Do GP 6.2.16 FIRMWARE UPGRADE Procedure to Re-flash the firmware for the FuturoPunch Pro.

This clears the fault

Yes- Resume normal operation; **No-** Go to Step 11

12. Replace the driver board for the faulty motor, with DIP switch set correctly for the position you are replacing- REP 2.26

This clears the fault

Yes- Resume normal operation; **No-** Go to Step 12

13. Replace the faulty stepper motor

REP 2.23 for M1, M2, M6, M7 and M8

REP 3.8 for M3 and M4

REP 3.5 for M5

This clears the fault

Yes- Resume normal operation; **No-** Go to Step 13

14. Replace the cables from control board to driver board.

If LED1 of any of the driver board is not lit, Replace 023N01339 (PL 7.3)

For other issues, replace one of the below cables:

023N01323 for M3, M4 and M5 (PL7.3#)

023N01334 for M6, M7 and M8 (PL 7.3)

023N01333 for M1 and M2 (PL 7.3)

This clears the fault

Yes- Resume normal operation; **No-** Go to Step 14

15. Replace Main Control Board (REP 5.1)

This clears the fault

Yes- Resume normal operation; **No-** Escalate to second level

6 OTHER FAULTS

RAP 6.1 Die Set Will Not Slide In or Out Easily

Use this RAP when the Die Set will not slide in or out using a moderate pull.

1. Do GP 6.27 *Die Lock Mechanism and Die Rail Springs Inspection*.

This clears the fault

Yes- Return to normal operation; **No-** Go to Step 2

2. Check if the Punch Cam needs to be indexed. Do ADJ 1.5 *Punch Cam Indexing* and perform the adjustment if necessary.

This clears the fault

Yes- Return to normal operation; **No-** Escalate to second level

RAP 6.2 Punch Overheats

Use this RAP if the Punch Overheats.

1. Check that the Exhaust Fan operates when power is on. Do GP 6.2.12 *Function Tests- Fan Test*.

The Exhaust Fan operates

Y N

| Go to step 2.

To prevent excessive heat build-up, the maximum recommended monthly punch volume should not exceed 400,000. In addition, no more than 2 sheets of 300gsm per 5 sheets of 75 gsm.

This clears the fault

Y N

| Go to step 2.

Normal operation.

2. Check for obstructions at the vents in the Rear Cover.

This clears the fault.

Y N

| Go to step 3.

To prevent excessive heat build-up the maximum recommended monthly punch volume should not exceed 400,000. In addition, no more than 2 sheets of 300gsm per 5 sheets of 75 gsm.

3. Check for 24 VDC on Wire 7715267 at the Exhaust Fan.

There is 24 VDC

Y N

| Go to step 4 to check input power.

Replace the Exhaust Fan (PL 2.2).

4. Check for 24 VDC on Wire 127N07842 at Connector J20 on the Control Board (see Section 7 Wiring)

There is 24 VDC

Y N

| Do RAP 1.3 No Power to Control Board.

Replace Wire 127N07842 (PL 7.3)

RAP 6.3 Dog ear corners in sheets

Use this RAP when the one of both corners of the sheets have dog ears.

1. Make sure the curl of printed sheets entering the punch are within specifications (Section 3.14)

The curl is within specifications.

Yes- Go to Step 2; **No-** Adjust the curl to be within specification

2. Check the operation of Diverter solenoid- do RAP 4.1

This clears the fault

Yes- Return to normal operation; **No-** Go to Step 3.

3. Check and clear and obstructions in the paper path.

This clears the fault

Yes- Return to normal operation; **No-** Go to Step 4.

4. Inspect the sheet guides (stainless steel guides) in the die throat. They should be firmly affixed to the plates of the die and should be parallel.

The sheet guides are normal.

Yes- Escalate to second level;

No- If there is another dieset at the location, try it. Escalate to second level.

**Appendix
Jam Codes**

Jam code	Description	Jam Type	Reference
J101	S1 covered for too long	A (punch) F (bypass)	Jam Types
J126	S26 covered for too long	F	Jam Types
J150	Dynamic jam in bypass mode (not DFA)	F	Jam Types
J151	Dynamic jam in bypass mode (not DFA)	F	Jam Types
J202	S2 covered for too long	B	Jam Types
J203	S3 covered for too long	B	Jam Types
J204	S4 covered for too long	B	Jam Types
J205	S5 covered for too long	B	Jam Types
J220	S20 covered for too long	B	Jam Types
J221	S21 covered for too long	B	Jam Types
J218	S18 covered for too long	B	Jam Types
J219	S19 covered for too long	B	Jam Types
J305	S5 covered for too long	C	Jam Types
J316	S16 covered for too long	C	Jam Types
J317	S17 covered for too long	C	Jam Types
J411	S11 covered for too long	C	Jam Types
J412	S12 covered for too long	C	Jam Types
J413	S13 covered for too long	C	Jam Types
J414	S14 covered for too long	C	Jam Types
J415	S15 covered for too long	C	Jam Types

Jam code	Description	Jam Type	Reference
J431	Sheet cannot be double punched.	-	RAP 2.9
J432	Fail safe stop reached	-	RAP 2.10
J433	Maximum deskew	-	RAP 2.11
J506	S6 covered for too long	D	Jam Types
J507	S7 covered for too long	D	Jam Types
J508	S8 covered for too long	D	Jam Types
J509	S9 covered for too long	D	Jam Types
J510	S10 covered for too long	D	Jam Types
J622	S22 covered for too long	E	Jam Types
J623	S23 covered for too long	E	Jam Types
J624	S24 covered for too long	E	Jam Types
J625	S25 covered for too long	E	Jam Types

3. Punch Quality

Section Contents

Title	Page
3.1 Punch Quality	3
3.2 Defect Entry RAP Procedure	3
3.3 Hole Quality.....	4
3.3.1 Hanging Chad	4
3.3.2 Holes are not cleanly cut.....	4
3.3.3 Oil on Paper	4
3.4 Alignment Offset.....	4
3.5 Backgage Offset.....	5
3.6 Skewed Punch	6
3.7 Punching Accuracy Inconsistent	6
3.8 Sheet Without Punched Holes	8
3.9 Punched holes look elongated towards the trail edge of the sheet.....	9
3.10 Sheet Damaged at the Lead Edge of the Sheet	10
3.11 Scuff Marks on Paper.....	10
3.12 Wrinkle in the sheet.....	10
3.13 Clear Cover media hole position	10
3.14 Punch Specifications	11

This page intentionally left blank.

3.1 Punch Quality

This section contains information related to the quality of the output such as hole quality or alignment.

3.2 Defect Entry RAP Procedure

Inspect the quality of the punch by referring to the specifications for Punch position and registration.

1. Do GP 6.1.10 DIE CYCLES Procedure to check the cycle life on the Die Set installed in the AdvancedPunchPro.
2. If any of the Die Set life cycles have exceeded 750,000 sheets (cycles) go to Section 3 and check the Punch Quality.

DIE CYCLES	↙
750,129	

- If the Punch Quality is acceptable monitor the Punch Quality frequently to ensure that the Punch Quality is okay.
 - If the Hole Quality is not acceptable replace the Die Set.
3. Defects in the appearance of the punch such as hole skew or non-uniformity are diagnosed in the following sections.

3.3 Hole Quality

There are three different Hole Quality problems:

- Hanging Chad
- Holes are not cleanly cut
- Oil on Paper

3.3.1 Hanging Chad

This is caused when the clearance between the pin and hole in a die-set increases.

Do GP 6.1.10 Die Cycles Procedure to check the number of cycles for the installed Die Set.

If Die Set cycles have exceeded 750,000, replace the Die Set with a new one.

3.3.2 Holes are not cleanly cut

This is usually caused due to lack of lubrication in the die-set. Do GP 6.7.3 Die Set Lubrication.

If lubricating the die set does not fix the issue, replace die-set.

3.3.3 Oil on Paper

After a die-set is lubricated the next 25-50 sheets will come out with oil around the punched holes. Running test sheets is recommended until oil marks cease to appear.

3.4 Alignment Offset

“Alignment Offset” refers to alignment in the fast scan or cross0 process direction.

Use this procedure if the Alignment of all the punched sheets is consistently off.

If the Alignment is not consistent- go to Section 3.7 Punching Accuracy Inconsistent.

1. Is the die configured for the correct sheet size?

See Section 8 of FuturoPunch Pro User Manual for details.

Die-set is configured correctly

Yes- Go to Step 2;

No- Configure the die correctly and return to normal operation

2. *For DFA Configurations only-* Do GP 6.2.2 to check if line speed is set correctly.

Line speed is set correctly

Yes- Go to Step 3;

No- Correct the line speed and return to normal operation

3. Do GP 6.1.3 Alignment Offset

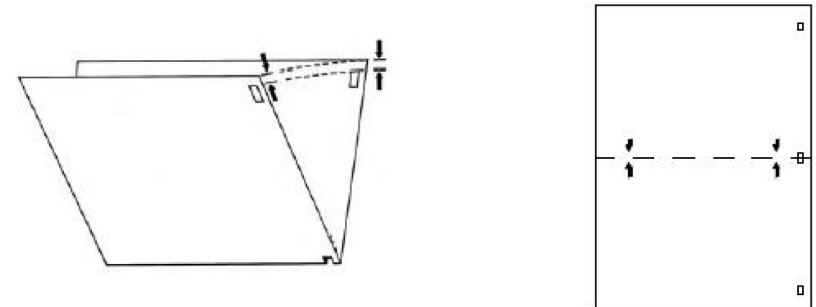

Figure 3-1 Hole Alignment on Finished Sheet

This clears the fault

Yes- Return to normal operation; **No-** Go to Step 4

4. Inspect the Die Stop Magnet. Do ADJ 1.3, Die Stop Adjustment.

This clears the fault

Yes- Return to normal operation; **No-** Go to Step 5

5. Inspect the die stop block of the die set, tighten if necessary.

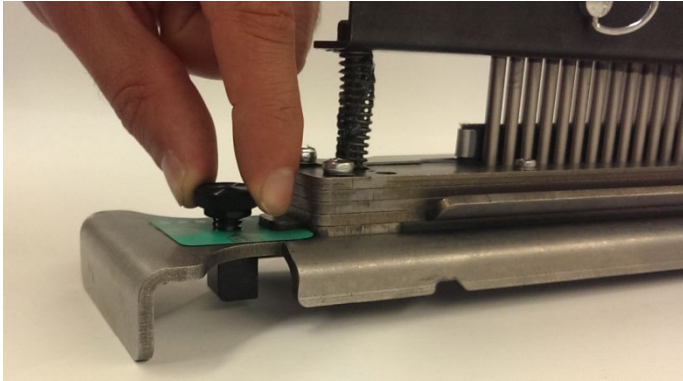

This clears the fault

Yes- Return to normal operation;

No- Go to Section 3.7 Punching accuracy inconsistent

3.5 Backgage Offset

“Backgage Offset” refers to alignment in slow scan or process direction.

Do the following steps if the Backgage is offset from correct position on all sheets consistently.

- If the backgage position is correct for the first punched sheet in a job and incorrect for all subsequent sheets, go to Step 4.
 - If the punched hole positions are not consistent for all sheets, go to section 3.7 *Punching Accuracy Inconsistent*.
1. Do GP 6.1.1 Backgage Offset.

This clears the fault

Yes- Return to normal operation; **No-** Go to Step 2

2. If the backgage depth is too shallow (holes towards the trail edge of the sheet), do RAP 4.3 to check Solenoids SOL 6, SOL 7, and SOL 8.

This clears the fault

Yes- Return to normal operation; **No-** Go to Step 3

3. Do RAP 4.1 to check Sensors S22, S23 and S24.

This clears the fault

Yes- Return to normal operation;

No- Go to Step 4

4. Do RAP 4.3 to check Solenoid SOL 6.

This clears the fault

Yes- Return to normal operation;

No- Go to Section 3.7 Punching Accuracy Inconsistent

3.6 Skewed Punch

1. Check if the die is locked down properly. This is described in Section 4 (A) of the FuturoPunch Pro User Manual.

Die is properly locked

Yes- Go to Step 2;

No- Lock the die properly and return to normal operation

2. If the holes are consistently skewed, do GP 6.2.13 Skew Offsets Procedure. Otherwise go to section 3.7 *Punching Accuracy Inconsistent*.

This clears the fault

Yes- Return to normal operation;

No- Go to Section 3.7 *Punching Accuracy Inconsistent*

3.7 Punching Accuracy Inconsistent

1. Check if the die is locked down properly, by inspecting the die lock plunger. This is described in Section 4 (A) of the FuturoPunch Pro User Manual.

Die is properly locked

Yes- Go to Step 2;

No- Lock the die properly and return to normal operation

2. Punching will be inaccurate if Solenoid SOL 6, SOL 7, or SOL 8 (PL 4.4) is not disengaging the roller completely when actuated (punched holes will be shifted towards the trail edge of the sheet in this case).
 - Do the following to check whether SOL6, 7 or 8 is causing the punch accuracy inconsistency,
 1. Leave the front door open and insert an interlock cheater.
 2. Leave the jam access panel of area #5 open.
 3. Run a 2~3 sheet job in punch job through the printer.
 4. Punched sheets will collect near area #5, gently pull the sheets and inspect the punch accuracy.
 5. If the punching accuracy is good, it means SOL6 or SOL7 or SOL8 is not functioning properly.
 6. Do RAP 5.3 to Check Solenoids SOL 6, SOL7 and SOL8.

For DFA configuration only- If the punching accuracy is inconsistent for mid punch of Double punched sheets, do RAP 5.3 to check Solenoids SOL 4 and SOL 5 in addition to the above steps.

This clears the fault

Yes- Return to normal operation; No- Go to Step 3

3. Do REP 3.1.1 to remove the Punch module and do Steps 4, 5 and 6.

4. Do GP 6.27 Die Lock Mechanism and Die Rail Springs Inspection.

This clears the fault

Yes- Return to normal operation; No- Go to Step 5

5. Do GP 6.24 Punch Clutch Inspection and Cleaning.

This clears the fault

Yes- Return to normal operation; No- Go to Step 6

6. Check if the set screws in the pulley of Aligner stepper motor are secure (PL 5.2). This can be checked by holding down the Alignment stepper pulley and trying to move the Aligner carriage on its rails. There should not be any play in the mechanism.

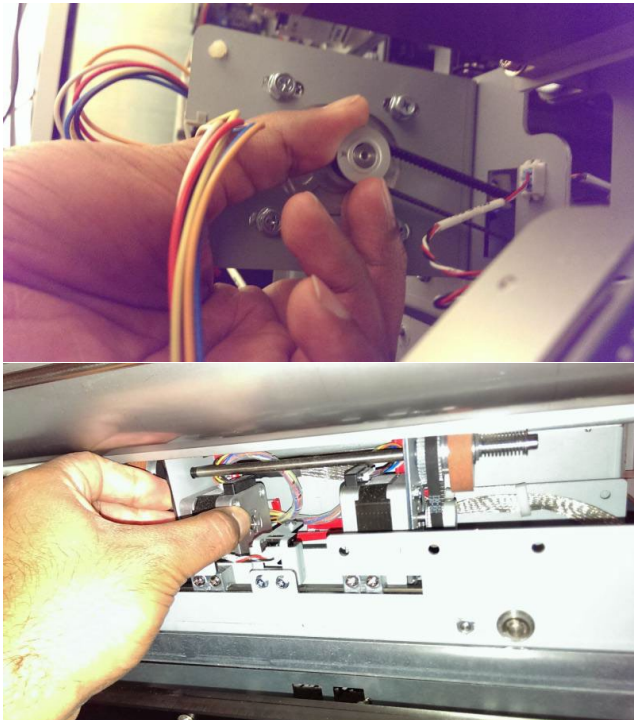

The set screws are secured tightly.

Yes- Go to Step 7;

No- Tighten set screw(s) and return to normal operation

7. There are three more pulleys involved in the Aligner drive (PL 5.3).

- Driven pulley of the Alignment Stepper motor
- Pulley adjacent to the driven pulley
- Pulley on the other shaft of the Aligner drive.

Make sure all the set screws in these three pulleys are tightened securely. If the pulley uses a coiled spring pin, make sure the spring is not broken.

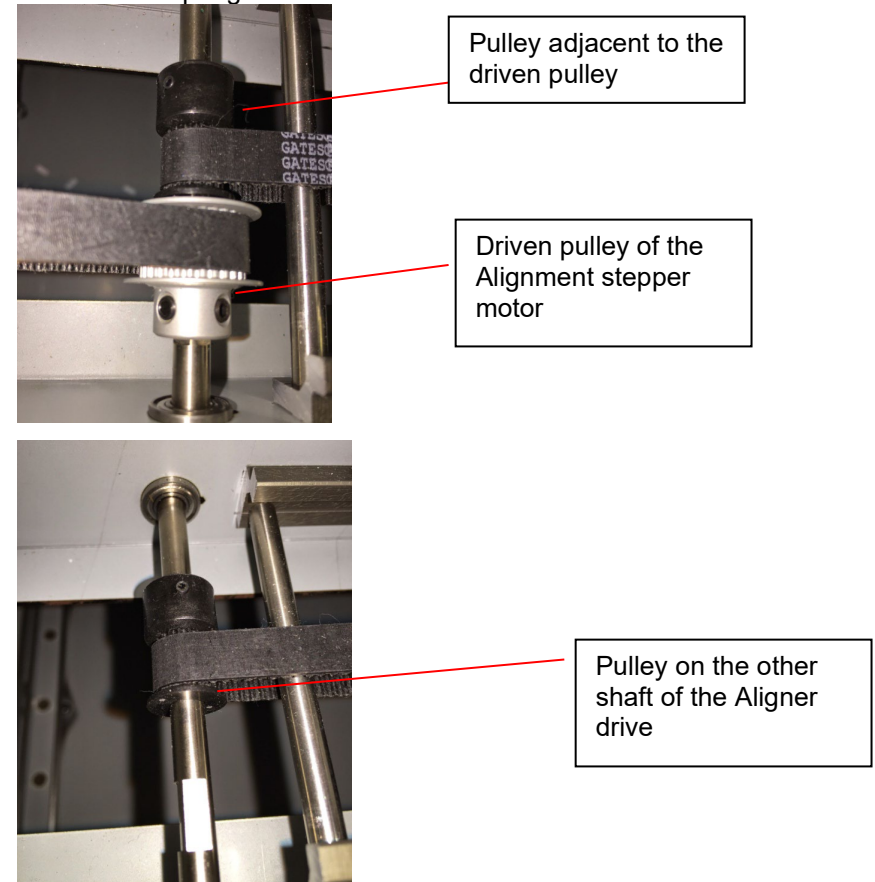

The set screws are secured tightly.

Yes- Escalate to 2nd level

No- Tighten set screw(s) and return to normal operation

3.8 Sheet Without Punched Holes

1. Do RAP 4.1 to check the Diverter Solenoid.

This clears the fault

Yes- Return to normal operation; **No-** Go to Step 2

2. Do RAP 3.2 to Check Sensors S6, S7, S8, S9 and S10. *For DFA configuration only- If it is Double Punch job, also check S18, S19, S20, and S21.*

This clears the fault

Yes- Return to normal operation; **No-** Go to Step 3

3. Do RAP 3.1 to Check Sensor S5.

This clears the fault

Yes- Return to normal operation; **No-** Go to Step 4

4. Do RAP 3.3 checking Sensor S28 Align Home Sensor.

This clears the fault

Yes- Return to normal operation; **No-** Go to Step 5

5. Do GP 6.2.12 Function Tests- Cycle Punch and do the following steps.

6. If you do not hear the Punch cycles and do not hear the AC Motor running, remove the Rear Cover and do step 7.

If you do not hear the punch cycles, but you do hear the AC Motor Running, go to step 8 or step 9.

7. Check the AC Punch Motor connections at the header in the Rear Frame and the Control Board.

- Inspect the cable from the AC punch motor to the header and the cable from the header to Control board (023N01340- see Section 7 Wiring). If a cable is damaged, replace it (PL 7.3)
- Do GP 6.2.16 FIRMWARE UPGRADE Procedure to Re-flash the firmware for the FuturoPunch Pro.
- With the Rear Cover removed, do GP 6.2.12 Function tests- Cycle Punch. Check the relay towards the bottom left of the main control board. You should be able to see the relay make contact when the punch motor starts. If this does not happen, replace control board (REP 5.1).



- If the relay makes contact, replace the AC Punch motor (REP 3.2).

This clears the fault

Yes- Return to normal operation; **No-** Escalate to 2nd level

8. If the motor is running, but clutch is not operating:

- Remove the Rear Cover.
- Check the spade connectors at the punch clutch (PL 5.1 and 5.6) and the connector at the Main control board J19 (PL 7.1), inspect clutch wires.
- Do GP 6.2.16 FIRMWARE UPGRADE Procedure to Re-flash the firmware for the FuturoPunch Pro.
- If the problem still exists, replace punch clutch.

This clears the fault

Yes- Return to normal operation; **No-** Go to Step 9

9. Check the Belt and Pulley for the AC Punch Motor.

- Inspect the timing Belt between the AC Punch Motor and the Clutch (PL 5.1).
- Check the tightness of the Setscrew of the AC Punch Motor (PL 5.8).

This clears the fault

Yes- Return to normal operation; **No-** Escalate to 2nd level.

10. Check that the clutch set screws are secure to the shaft.

- Check that the clutch set screws are tight on the shaft (reference ARP 3.7 to access the clutch)
- If the set screws are loose perform ARP 3.7 Installation steps to reset them.
- If the clutch cannot be reoriented to align with the notches in the shaft, remove the clutch and inspect the shaft for damage (PL 4.1). If the shaft is undamaged reinstall the clutch in the proper position and resume operation.
- Replace the punch module shell if the shaft is damaged (PL 4.1)

This clears the fault

Yes- Return to normal operation; **No-** Escalate to 2nd level.

3.9 Punched holes look elongated towards the trail edge of the sheet

This failure usually occurs when the Punch cycle is slowed.

1. Lubricate die-set. Do GP 6.7.3.

This clears the fault

Yes- Return to normal operation; **No-** Go to Step 2

2. Check if correct pulley is used depending on 115V or 230V machine, 115V machine should use 38T pulley and 230V machine should use 34T pulley (PL 5.6).

The correct pulley is used.

Yes- Go to Step 3; **No-** Change the pulley

3. Check the number of punch cycles of the machine, do GP 6.1.11 Punch Cycles. The normal life of the punch clutch is 15 million punch cycles. If the machines has completed 15 million punch cycles, do REP 3.1 to replace the Punch Module.

The punch has less than 15 million cycles

Yes- Go to Step 4;

No- Replace the punch module (REP 3.1)

4. Do GP 6.24 Punch Clutch Inspection and Cleaning.

This clears the fault

Yes- Return to normal operation; **No-** Escalate to 2nd level

3.10 Sheet Damaged at the Lead Edge of the Sheet

1. Do RAP 3.8 to check for an obstruction of the paper path.

This clears the fault

Yes- Return to normal operation; **No-** Go to Step 2

2. Remove the die set and inspect the die set throat for any obstruction.

This clears the fault

Yes- Return to normal operation; **No-** Escalate to 2nd level

3.11 Scuff Marks on Paper

1. Clean all drive and idler rollers, do

- GP 6.14.1 Idler Roller Cleaning
- GP 6.14.2 Steering Idler Roller and Springs Inspection and Cleaning
- GP 6.15 Drive roller and Steering drive roller Inspection and Cleaning

This clears the fault

Yes- Return to normal operation; **No-** Go to Step 2

2. Do RAP 4.3 to inspect Solenoids SOL 3, SOL 4, SOL 5, SOL 6, SOL 7, and SOL 8.

This clears the fault

Yes- Return to normal operation; **No-** Go to Step 3

3. Do RAP 3.1 to inspect Sensors S3, S4, S5, S22, S23, and S24

This clears the fault

Yes- Return to normal operation; **No-** Escalate to 2nd level

3.12 Wrinkle in the sheet

1. If the wrinkling is at the trail edge of the sheet, Do RAP 4.1 to check Sensor S24.

This clears the fault

Yes- Return to normal operation; **No-** Go to Step 2

2. Do RAP 5.3 to inspect Solenoids SOL 6, SOL 7, and SOL 8.

This clears the fault

Yes- Return to normal operation; **No-** Escalate to 2nd level

3.13 Clear Cover media hole position

1. If the hole position (Backgage and Alignment) of Clear media differs from the hole position of plain media, do GP 6.1.5 CLEAR COVER Procedure

This clears the fault

Yes- Return to normal operation; **No-** Go to Step 2

2. Check the function of Sensor S1b. See GP 6.2.7 Sensor Procedure.

Sensor S1b functions properly

Yes- Escalate to next level; **No-** Go to Step 3

3. Ensure the sensor S1b is connected properly on the receiver side and emitter side.

Sensor S1b is connected properly

Yes- Escalate to next level; **No-** Go to Step 4

4. Replace defective S1b receiver or emitter if needed.

New S1b sensors correct the issue.

Yes- Continue normal operation; **No-** Escalate to next level.

3.14 Punch Specifications

Speed	Up to 157 sheets per minute
Punch Sheet Size and Edge LEF- Long Edge Fed SEF- Short Edge Fed	US Sizes LTR LEF LTR SEF Statement LEF Legal SEF Ledger SEF 9" x 12" SEF 9" x 12" LEF 12" x 18" SEF <i>DFA Configurations offer Double Punching below sizes: LTR SEF; Ledger SEF; 9x12 SEF; 12x18 SEF</i> ISO sizes A4 LEF A4 SEF A5 LEF A3 SEF SRA4 SEF SRA4 LEF SRA3 SEF <i>DFA Configurations offer Double Punching below sizes: A4 SEF; A3 SEF; SRA4 SEF; SRA3 SEF</i>
Paper Stock for Punch job	Plain: 75gsm - 300gsm (20# bond to 110# cover) Coated: 120gsm - 300gsm (32# bond to 110# cover)
Bypass Mode Sheet size	Paper sizes and stocks same as printer

Punch Capacity	Single Sheet	
Electrical	Amps and Frequency	115V: 3.8 A; 60 Hz 230V: 1.9 A; 50 Hz
Safety	cULus / GS	
Dimensions	L: 730mm; W: 445mm; H: 990mm	
Weight	97 kg	

Sheet Entrance and Exit Specifications

Curl variance at entrance	±12.7mm
Alignment variance at pick up	±8.0mm from Center justified
Speed variance at pick up	±2%
Skew variance at pick up	±25mrads
Alignment variance at exit	±2.0mm from Center justified
Skew variance at exit	±5mrads for Punch job (incremental to skew at entrance for bypass job)
Speed variance at exit	±1% compared to speed variance at pick up

Maximum recommended monthly volume	400,000 Punch cycles
Maximum Punch duty cycle	In addition to above, no more than 2 sheets of 300gsm per 5 sheets of 75gsm

Punch Accuracy

Hole Size	±2%
Alignment position	±0.5mm (with 1% ±0.5 to ±1.0mm)
Backgauge Depth (at center)	±0.3mm (with 1% ±0.3 to ±0.8mm)
Skew	±0.6mm (with 1% ±0.6 to ±1.0mm)

Duty Cycles

4. Repairs/Adjustments

Section Contents

1. Cabinet	4-3
REP 1.1 Top Cover Replacement	4-3
REP 1.2 Front Door Replacement	4-4
REP 1.3 Front Door Bottom Hinge Bracket Replacement	4-5
REP 1.4 Front Door Top Hinge Bracket Replacement	4-5
REP 1.5 Panel Open Magnet Replacement	4-6
REP 1.6 Rear Cover Replacement	4-7
REP 1.7 Upstream Rear Side Cover Replacement	4-8
REP 1.8 Upstream Side Frame Cover Replacement	4-9
REP 1.9 Downstream Front Side Cover Replacement	4-10
REP 1.10 Downstream Rear Side Cover Replacement	4-11
REP 1.11 Downstream Side Frame Cover Replacement	4-12
REP 1.12 Door Latch Replacement	4-13
REP 1.13 Interlock Switch Replacement	4-14
REP 1.14 LCD Display Replacement	4-15
REP 1.15 LCD Membrane Switch Panel Replacement	4-17
REP 1.16 Caster Replacement	4-18
REP 1.17 Docking Bracket Replacement	4-19
REP 1.18 Exhaust Fan Replacement	4-21
REP 1.19 Drive roller Cover removal	4-23
2. Paper Path	4-24
REP 2.1 Lower Entrance Panel Replacement	4-24
REP 2.2 Entrance Idler Panel Replacement	4-26
REP 2.3 Acceleration Roller Idler Assembly Replacement	4-28
REP 2.4 Entrance Drive Panel Assembly Replacement	4-30
REP 2.5 Punch Lower Exit Panel Replacement	4-34
REP 2.6 Exit Idler Panel Replacement	4-35
REP 2.7 Drive Exit Panel Replacement	4-37
REP 2.8 Lower Exit Panel Replacement	4-39
REP 2.9 Upper Bypass Panel Replacement	4-40

Title	Page
REP 2.10 Lower Bypass panel replacement	4-42
REP 2.11 Panel Close Magnet Replacement	4-43
REP 2.12 Idler Roller Replacement	4-44
REP 2.13 Flange Ball Bearing Replacement	4-46
REP 2.14 Snap-in Bearing Replacement	4-47
REP 2.15 Bearing Housing Replacement	4-48
REP 2.16 Accel Idler Latch Handle Replacement	4-49
REP 2.17 Accel Idler Latch Shaft, Rear Latch and Front Latch Assembly Replacement	4-50
REP 2.18 One Way Clutch and Pulley Sub-Assembly Replacement	4-53
REP 2.19 Drive Idler Roller Assembly Replacement	4-53
REP 2.20 Timing Pulley Replacement	4-54
REP 2.21 Timing Belt Replacement	4-55
REP 2.21.1 534T Belt Replacement	4-55
REP 2.21.2 134T Belt Replacement	4-56
REP 2.21.3 150T Belt Replacement	4-56
REP 2.21.4 179T Belt Replacement	4-57
REP 2.22 Drive Roller Assembly Replacement	4-58
REP 2.22.1 Drive Roller N5 Replacement	4-60
REP 2.23 Stepper and Mount Assembly Replacement	4-63
REP 2.24 Bypass Open Sensor Replacement	4-64
REP 2.25 Paper Path Sensor Replacement	4-65
REP 2.25.1 Entrance Sensor (S1,) Exit Sensor (S25), and Bypass Middle Sensor (S26) Replacement	4-65
REP 2.25.2 Top, Middle, & Bottom Entrance Sensor (S2, S3, S4) and Top, Middle, & Bottom Exit Sensor (S22, S23, S24) Replacement	4-66
REP 2.25.3 Accel Sensor (S5) Replacement	4-67
REP 2.25.4 Align Home Sensor (S28) Replacement	4-68
REP 2.25.5 Double Punch (Large) Backage Sensor Board Assembly (S18, S19) and Double Punch (X-Large) Backage Sensor Board Assembly (S20, S21) Replacement	4-69
REP 2.25.6 Skew Sensor Board (S6 – S10) Replacement	4-70
REP 2.25.7 Alignment Sensor Board (S11 – S15) Replacement	4-71

REP 2.25.8 Backage Sensor Board (S16, S17) Replacement	4-73
REP 2.26 Motor Driver (Stepper Driver) Replacement	4-74
REP 2.27 Bypass Diverter Replacement	4-76
REP 2.28 Solenoid Replacement.....	4-77
REP 2.28.1 Diverter Solenoid Replacement.....	4-78
REP 2.28.2 Entrance Idler Solenoid Replacement	4-79
REP 2.28.3 Acceleration Roller Idler Solenoid Replacement	4-79
REP 2.28.4 Exit Idler Solenoid Replacement	4-80
REP 2.29 Upper Bypass Panel Anti-Static Brush Replacement	4-81
REP 2.30 Chip Tray Home Switch Replacement.....	4-81
REP 2.31 Chip Level Emitter Replacement	4-83
REP 2.32 Chip Level Receiver Replacement	4-83
3. Punch Module	4-84
REP 3.1 Punch Module Replacement	4-84
REP 3.1.1 Punch Module Removal	4-84
REP 3.1.2 Punch Module Installation	4-87
REP 3.2 Punch Motor Replacement	4-88
REP 3.3 Punch Motor Belt Replacement (Timing Belt).....	4-89
REP 3.4 Clutch or Clutch Pulley Replacement	4-91
REP 3.5 Punch Alignment Stepper Motor and Pulley Replacement..	4-94
REP 3.6 Steering Module Replacement	4-95
REP 3.7 Alignment Carriage Sub Assembly Replacement.....	4-98
REP 3.8 Steering Stepper Motor Replacement	4-100
REP 3.9 Steering Motor Belt (65 Groove) Replacement.....	4-102
REP 3.10 Steering Idler Panel Weldment Replacement.....	4-104
REP 3.11 Steering Idler Roller Assembly Replacement	4-105
REP 3.11.1 Steering Idler Roller Bearing Replacement	4-107
REP 3.12 Steering Drive Panel Weldment Replacement	4-108
REP 3.13 Die Lock Plunger and Stripper Assembly Replacement	4-109
REP 3.14 Die Lock Shaft Replacement	4-110
REP 3.15 Die Rail Assembly and Die Rail Springs Replacement..	4-112
REP 3.16 Backgage Sensor Bracket Weldment and Backgage Sensor Lower Bracket Replacement.....	4-115

4. Power Supply	4-116
REP 4.1 24V Power Supply Replacement	4-116
REP 4.2 AC Filter Replacement.....	4-118
5. Electronics and Control	4-119
REP 5.1 Main Control Board Replacement.....	4-119
REP 5.2 Comm Board Replacement.....	4-121
REP 5.3 Dieset Recognition Reader Board Replacement	4-122
6. Adjustments	4-123
ADJ 1.1 Door Latch Adjustment	4-123
ADJ 1.2 Diverter Solenoid Adjustment	4-124
ADJ 1.3 Die Stop Magnet Adjustment	4-126
ADJ 1.4 Timing Belts Adjustment	4-127
ADJ 1.5 Punch Cam Indexing.....	4-132
ADJ 1.6 Dieset Recognition Board Adjustment	4-136
ADJ 1.7 Idler Panel Magnetic Latches Adjustment.....	4-137
ADJ 1.8 Drive Panel Position Adjustment.....	4-138

REPLACEMENTS

1. Cabinet

REP 1.1 Top Cover Replacement

PARTS LIST ON PL 2.2

Use this procedure to remove and install the Top Cover Assembly.

Removal Procedure

WARNING

Do not perform repair activities with the power on or electrical power supplied to the machine. Some machine components contain dangerous electrical voltages that can result in electrical shock and possible serious injury. See Section 0, page vi for other languages.

1. Switch power OFF to entire printing system.
2. Disconnect the Power Cord from FuturoPunch Pro.
3. Open the Front Door.
4. Do REP 1.6 to remove the Rear Cover.
5. Do REP 1.11 to remove the Upper Downstream Side Frame Cover.
6. Remove the Phillips Head Screws (4) from the Top Cover Tabs.

Caution: Top Cover will drop upon removal of fasteners. Stabilize the Top Cover with your free hand to insure the Top Cover does not fall unexpectedly.



7. Disconnect the LCD Panel Connector and release the LCD Cable from wire saddles.
8. Remove the Top Cover.

Installation Procedure

Use this procedure to install the Top Cover Assembly.

1. Place the Top Cover in position.
2. Install and tighten the Phillips Head Screws (4) through the Tabs.
3. Connect the LCD Panel Connector and place the LCD Cable in the wire saddles.
4. Do REP 1.11 to install Upper Downstream Side Frame Cover.
5. Close the Front Door.
6. Do REP 1.6 to install the Rear Cover.
7. Connect the Power Cord.
8. Power ON the entire printing system.

REP 1.2 Front Door Replacement

PARTS LIST ON PL 2.2

Use this procedure to remove and install the Front Door Assembly

Removal Procedure

WARNING

Do not perform repair activities with the power on or electrical power supplied to the machine. Some machine components contain dangerous electrical voltages that can result in electrical shock and possible serious injury. See Section 0, page vi for other languages.

1. Switch power OFF to entire printing system.
2. Disconnect the Power Cord.
3. Open the Front Door.
4. Lightly trace the perimeter of the Top Hinge bracket fasted to the interior of the Front door.
5. Remove two M4 nuts and washers securing the Top hinge bracket to the Front Door. Carefully remove the bracket while securing the Front Door with your free hand to prevent movement.

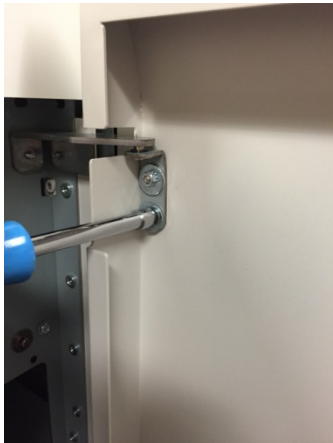

6. Lift the Door up off the pin on the Front Door Bottom Hinge Bracket.
7. Remove the Front Door.
8. Remove the Interlock Switch actuator and latch receptacle (PL 2.2) from the old Door and install it on the new Door.
9. Remove the Magnet Strike Plate from the old Door and install it on the new Door.
10. Transfer the wrench and the mounting bracket to the new door.
11. Transfer Tag Matrix information to the new Front door.

Installation Procedure

1. Place the Front Door in position so the pin on the Front Door Bottom Hinge Bracket fits into the hole in the bottom of the Front Door.



2. Position the top of the Front Door and the Top Hinge bracket to engage the top hinge pin. Secure the bracket to the Front Door using the two washers and nuts. Adjust the bracket to align with the marks made before disassembly and firmly tighten the nuts
3. Close the Front Door.
4. If necessary, do ADJ 1.1 to adjust the Door Latch.
5. Power ON the entire printing system.

REP 1.3 Front Door Bottom Hinge Bracket Replacement

PARTS LIST ON PL 2.2

Use this procedure to remove and install the Front Door Bottom Hinge Bracket.

1. Switch power OFF to entire printing system.
2. Disconnect the Power Cord.
3. Do REP 1.2 Front Door Replacement to remove the Front Door.



Front Door
Bottom Hinge
Bracket

4. It is recommended to trace the perimeter of the hinge bracket before removal.
5. Remove the Screws (2) and the Front Door Bottom Hinge Bracket
6. Place the new Front Door Bottom Hinge Bracket in position and tighten the Screws (2).
7. Do REP 1.2 Front Door Replacement to install the Front Door.
8. Connect the Power Cord.
9. Power ON the entire printing system.

REP 1.4 Front Door Top Hinge Bracket Replacement

PARTS LIST ON PL 2.2

Use this procedure to remove and install the Front Door Top Hinge Bracket.

1. Switch power OFF to entire printing system.
2. Disconnect the Power Cord.
3. Do REP 1.2 Front Door Replacement to remove the Front Door.



Front Door
Top Hinge
Bracket

4. Remove the Screws (2) and the Front Door Top Hinge Bracket
5. Place the new Front Door Top Hinge Bracket in position and tighten the Screws (2).
6. Do REP 1.2 Front Door Replacement to install the Front Door.
7. Connect the Power Cord.
8. Power ON the entire printing system.

REP 1.5 Panel Open Magnet Replacement

PARTS LIST ON PL 3.2

Use this procedure to remove and install a Panel Open Magnet.

1. Switch power OFF to entire printing system.
2. Disconnect the Power Cord.
3. Open the Front Door.
4. Remove the Screws (2) and the Panel Open Magnet.

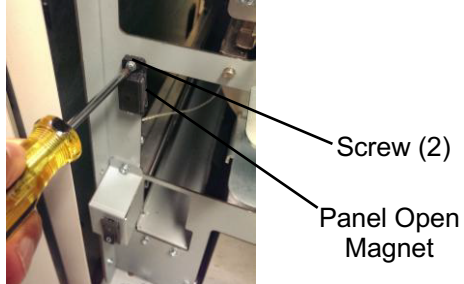

5. Place the Panel Open Bracket in position and tighten the Screws (2).
6. Close the Front Door.
7. Connect the Power Cord.
8. Power ON the entire printing system.

REP 1.6 Rear Cover Replacement

PARTS LIST ON PL 2.2

Use this procedure to remove and install the Rear Cover Assembly

Removal Procedure

WARNING

Do not perform repair activities with the power on or electrical power supplied to the machine. Some machine components contain dangerous electrical voltages that can result in electrical shock and possible serious injury. See Section 0, page vi for other languages.

1. Switch power OFF to entire printing system.
2. Disconnect the Power Cord.
3. Hold the Rear Cover in place so it doesn't fall as you remove the M4 Screws (6) from the Rear Cover.
4. Grasp the Rear Cover by the handle and remove the Rear Cover.



Installation Procedure

1. Place the Rear Cover in position.
2. Tighten the Screws (6) on the Rear Cover.
3. Connect the Power Cord.
4. Power ON the entire printing system.

REP 1.7 Upstream Rear Side Cover Replacement

PARTS LIST ON PL 2.2

Use this procedure to remove and install the Upstream Rear Side Cover.

Removal Procedure

WARNING

Do not perform repair activities with the power on or electrical power supplied to the machine. Some machine components contain dangerous electrical voltages that can result in electrical shock and possible serious injury. See Section 0, page vi for other languages.

1. Switch power OFF to entire printing system.
2. Disconnect the Power Cord.
3. Do GP 6.4 to undock the Punch from the upstream and downstream equipment.
4. Do REP 1.6 to remove the Rear Cover.
5. Remove the Screw from the right side of the Exhaust Fan Bracket Assembly.
6. Remove the Screws (6) holding the Upstream Rear Side Cover.



7. Remove the Upstream Rear Side Cover.

Installation Procedure

1. Place the Upstream Rear Side Cover in position.
2. Tighten the Screws (6) holding the Upstream Rear Side Cover.
3. Insert and tighten the Screw at the right side of the Exhaust Fan Bracket Assembly.
4. Do REP 1.6 to install the Rear Cover.
5. Do GP 6.3 to dock the Punch to the upstream and downstream equipment.
6. Connect the Power Cord.
7. Power ON the entire printing system.

REP 1.8 Upstream Side Frame Cover Replacement

PARTS LIST ON PL 2.2

Use this procedure to remove and install the Upstream Side Frame Cover.

Removal Procedure

WARNING

Do not perform repair activities with the power on or electrical power supplied to the machine. Some machine components contain dangerous electrical voltages that can result in electrical shock and possible serious injury. See Section 0, page vi for other languages.

1. Switch power OFF to entire printing system.
2. Disconnect the Power Cord.
3. Do GP 6.4 to undock the Punch from the upstream and downstream equipment.
4. Remove the Screws (4) on the entrance side.

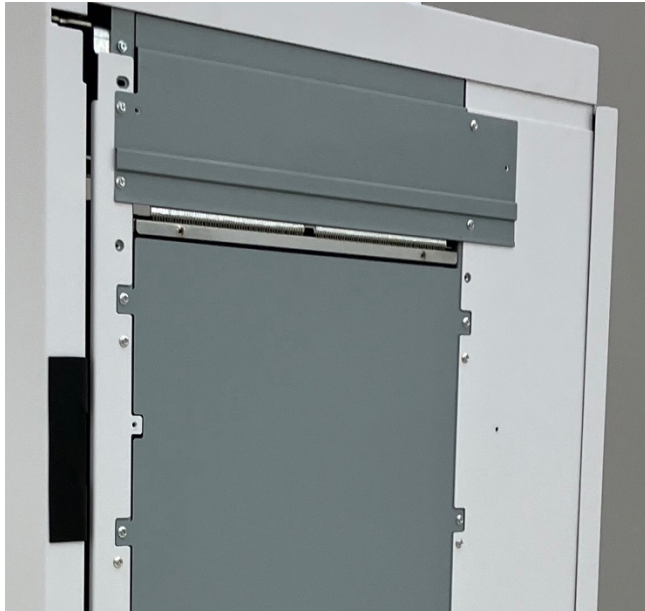

5. Remove the Upstream Side Frame Cover.

Installation Procedure

1. Place the Upstream Side Frame Cover in position.
2. Tighten the Screws (4) on the entrance side.
3. Do GP 6.3 to dock the Punch to the upstream and downstream equipment.
4. Connect the Power Cord.
5. Power ON the entire printing system.

REP 1.9 Downstream Front Side Cover Replacement

PARTS LIST ON PL 2.2

Use this procedure to remove and install the Downstream Front Side Cover.

Removal Procedure

WARNING

Do not perform repair activities with the power on or electrical power supplied to the machine. Some machine components contain dangerous electrical voltages that can result in electrical shock and possible serious injury. See Section 0, page vi for other languages.

1. Switch power OFF to entire printing system.
2. Disconnect the Power Cord.
3. Do GP 6.4 to undock the Punch from the upstream and downstream equipment.
4. Remove the Screws (4).

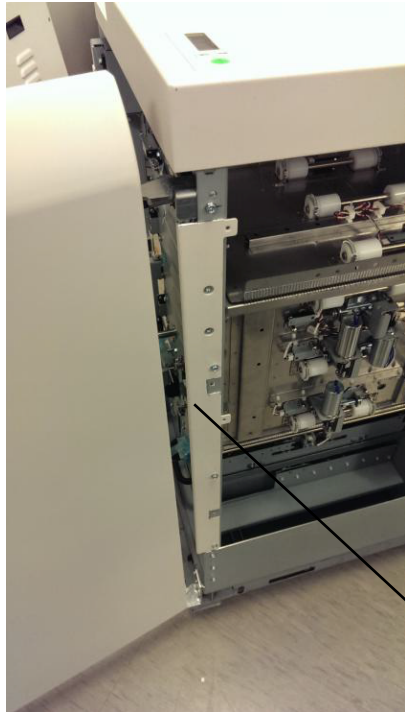

Downstream Front
Side Cover

5. Remove the Downstream Front Side Cover.

Installation Procedure

1. Place the Downstream Front Side Cover in position.
2. Tighten the Screws (4).
3. Do GP 6.3 to dock the Punch to the upstream and downstream equipment.
4. Connect the Power Cord.
5. Power ON the entire printing system.

REP 1.10 Downstream Rear Side Cover Replacement

PARTS LIST ON PL 2.2

Use this procedure to remove and install the Downstream Rear Side Cover.

Removal Procedure

WARNING

Do not perform repair activities with the power on or electrical power supplied to the machine. Some machine components contain dangerous electrical voltages that can result in electrical shock and possible serious injury. See Section 0, page vi for other languages.

1. Switch power OFF to entire printing system.
2. Disconnect the Power Cord.
3. Do GP 6.4 to undock the Punch from the upstream and downstream equipment.
4. Do REP 1.6 to remove the Rear Cover.
5. Release the wire saddles and cables.
6. Remove the Screw from the left side of the Exhaust Fan Bracket Assembly.
7. Remove the Screws (6) holding the Downstream Rear Side Cover.

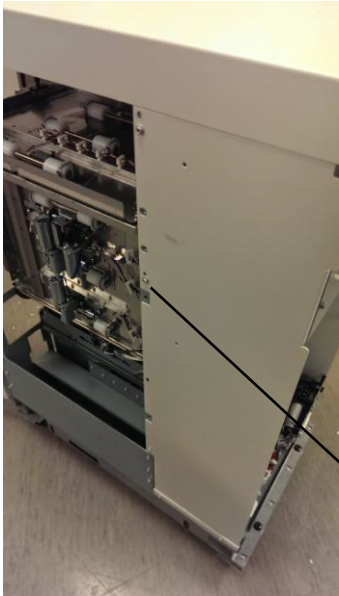

Downstream Rear
Side Cover

8. Remove the Downstream Rear Side Cover.

Installation Procedure

1. Place the Downstream Rear Side Cover in position.
2. Tighten the Screws (6) holding the Downstream Rear Side Cover.
3. Install and tighten the Screw at the left side of the Exhaust Fan Bracket Assembly.
4. Place the Cables in the wire Saddles and cose the wire saddles.
5. Do REP 1.6 to install the Rear Cover.
6. Do GP 6.3 to dock the Punch to the upstream and downstream equipment.
7. Connect the Power Cord.
8. Power ON the entire printing system.

REP 1.11 Downstream Side Frame Cover Replacement

PARTS LIST ON PL 2.2

Use this procedure to remove and install the Downstream Side Frame Cover

Removal Procedure

WARNING

Do not perform repair activities with the power on or electrical power supplied to the machine. Some machine components contain dangerous electrical voltages that can result in electrical shock and possible serious injury. See Section 0, page vi for other languages.

1. Switch power OFF to entire printing system.
2. Disconnect the Power Cord.
3. Do GP 6.4 to undock the Punch from the upstream and downstream equipment.
4. Remove the (2) screws and Docking plate off the Side cover you are uninstalling.



5. To remove the Upper downstream side frame cover, remove (4) screws (shown in blue).
6. To remove the Lower downstream side frame cover, remove (6) screws (shown in green).



7. Remove the Downstream Side Frame Cover.

Installation Procedure

1. Place the Downstream Side Frame Cover in position.
2. Tighten the Screws (4) on the exit side.
3. Do GP 6.3 to dock the Punch to the upstream and downstream equipment.
4. Connect the Power Cord.
5. Power ON the entire printing system.

REP 1.12 Door Latch Replacement

PARTS LIST ON PL 2.2

Use this procedure to remove and install the Door Latch Assembly.

WARNING

Do not perform repair activities with the power on or electrical power supplied to the machine. Some machine components contain dangerous electrical voltages that can result in electrical shock and possible serious injury. See Section 0, page vi for other languages.

Do the following to ensure the door latch holds the door closed and that the activating bracket tab depresses the door switch. The tab should press the switch button just so that it is close to bottoming out.

1. Switch power OFF to entire printing system.
2. Disconnect the Power Cord.
3. Open the Front Door.



4. Remove the two screws on the Door Latch.



5. Remove Screws (2) from the Interlock Box.

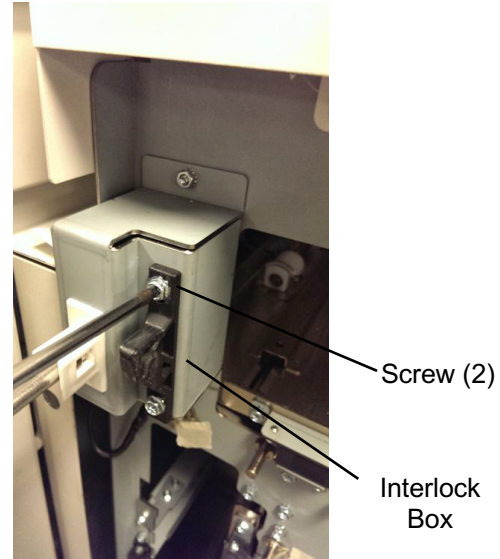

Installation Procedure

1. Remove the old Latch and put the new Latch in position.
2. Do ADJ 1.1 to adjust the Door Latch.
3. Tighten the Screws (4).
4. Close the Front Door.
5. Connect the Power Cord.
6. Power ON the entire printing system.
7. Test the Door Latch operation.

REP 1.13 Interlock Switch Replacement

PARTS LIST ON PL 2.2

Use this procedure to remove and install the Interlock Switch Assembly.

Removal Procedure

WARNING

Do not perform repair activities with the power on or electrical power supplied to the machine. Some machine components contain dangerous electrical voltages that can result in electrical shock and possible serious injury. See Section 0, page vi for other languages.

1. Switch power OFF to entire printing system.
2. Disconnect the Power Cord.
3. Open the Front Door.
4. Remove the M4 Nuts (2).

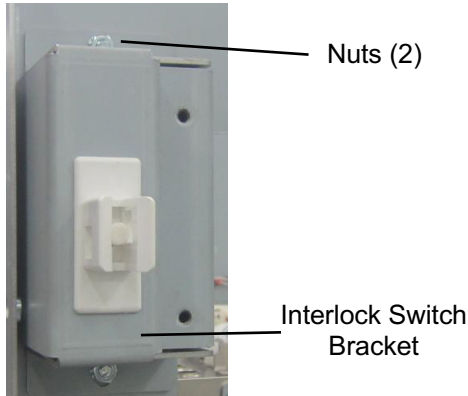

5. Remove the Interlock Switch Bracket.
Do not knock the Nuts (2) into the machine.
6. Press in the Tabs (2) on the sides of the Switch and remove the Interlock Switch from the Interlock Switch Bracket.

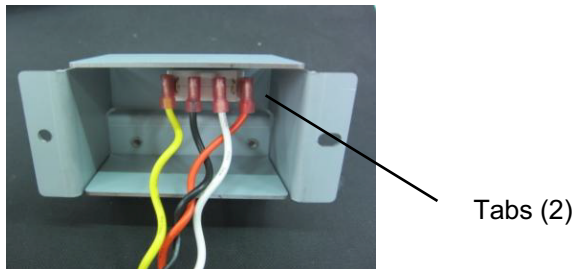

7. Note the location of the Wires (4); then disconnect the Wires from the Interlock Switch (PL 2.2).

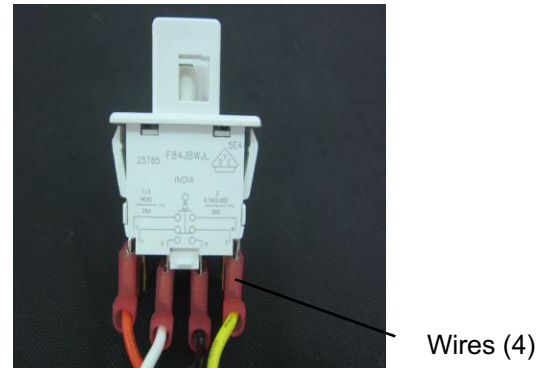

From right to left:

- Yellow wire – Position 8.
 - Black wire – Position 4.
 - White wire – Position 3.
 - Orange wire – Position 7.
8. Place the new Interlock Switch into the Interlock Switch Bracket. and press down until the Tabs lock in place.
 9. Connect the Wires (4) to the new Interlock Switch.
 10. Place the interlock Switch Bracket in position, and tighten the Nuts (2).
 11. Close the Front Door.
 12. Connect the Power Cord.
 13. Power ON the entire printing system.

7. Remove the LCD Display.

REP 1.14 LCD Display Replacement
PARTS LIST ON PL 2.2

Use this procedure to remove and install the LCD Display.

Removal Procedure

WARNING

Do not perform repair activities with the power on or electrical power supplied to the machine. Some machine components contain dangerous electrical voltages that can result in electrical shock and possible serious injury. See Section 0, page vi for other languages.

1. Switch power OFF to entire printing system.
2. Disconnect the Power Cord.
3. Do REP 1.11 to remove the Upper Downstream Side Frame Cover.
4. Open the Front Door.



LCD Display

5. Disconnect the Cables from the LCD Display.

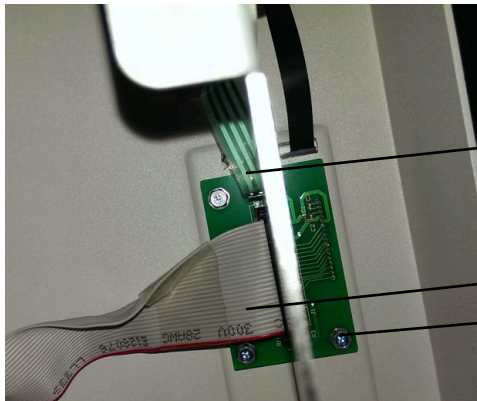

Cable

Cable

Screws

6. From the bottom side of the Top Cover, remove the Screws (3) holding the LCD Display to the Top Cover.

Installation Procedure

1. Place the new LCD Display Panel in position.
2. Tighten the Screws (3) holding the LCD Display to the Top Cover.
3. Connect the Cables to the LCD Display Panel.
4. Do REP 1.11 to remove the Upper Downstream Side Frame Cover.
5. Close the Front Door.
6. Connect the Power Cord.
7. Power ON the entire printing system.

REP 1.15 LCD Membrane Switch Panel Replacement

PARTS LIST ON PL 2.2

Use this procedure to remove and install the LCD Membrane Switch Panel.

WARNING

Do not perform repair activities with the power on or electrical power supplied to the machine. Some machine components contain dangerous electrical voltages that can result in electrical shock and possible serious injury. See Section 0, page vi for other languages.

1. Switch power OFF to entire printing system.
2. Disconnect the Power Cord.
3. Open the Front Door.
4. Disconnect the LCD Membrane Switch Connector from the LCD Display.



5. Remove the M4 nut that secures the strap to the Top cover.



6. Peel off the old LCD Membrane Switch.

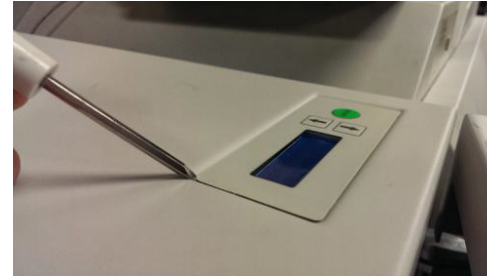

Installation Procedure

1. Install the new Membrane within the indent of the Top Cover.
2. Close the Front Door.
3. Connect the LCD Membrane Switch Connector from the LCD Display.
4. Connect the Power Cord.
5. Power ON the entire printing system.

REP 1.16 Caster Replacement

PARTS LIST ON PL 3.2

Use this procedure to remove and install the Caster Assembly.

Removal Procedure

WARNING

Do not perform repair activities with the power on or electrical power supplied to the machine. Some machine components contain dangerous electrical voltages that can result in electrical shock and possible serious injury. See Section 0, page vi for other languages.

1. Switch power OFF to entire printing system.
2. Disconnect the Power Cord.
3. Carefully lift the corner of the Punch by the Caster.
4. Loosen the Jam Nut.

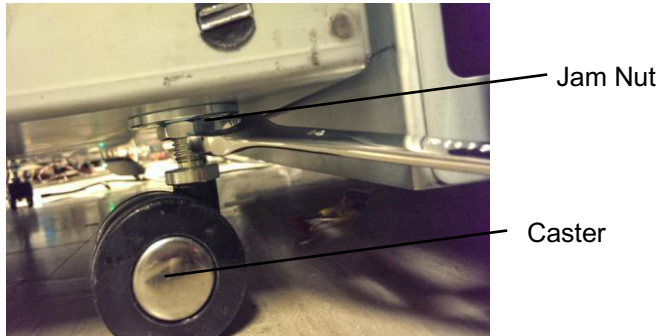

5. Unscrew the Caster to remove it.
6. Place the new Caster in position and screw it in.
7. Tighten the Jam Nut.
8. Lower the Punch
9. Connect the Power Cord.
10. Power ON the entire printing system.

REP 1.17 Docking Bracket Replacement

PARTS LIST ON PL 2.2

Use this procedure to remove and install the Docking Bracket Assembly.

Removal Procedure

WARNING

Do not perform repair activities with the power on or electrical power supplied to the machine. Some machine components contain dangerous electrical voltages that can result in electrical shock and possible serious injury. See Section 0, page vi for other languages.

1. Switch power OFF to entire printing system.
2. Disconnect the Power Cord.
3. Do GP 6.4 Undock the Punch to separate the Punch from the upstream and downstream devices.



(Cont.)

4. Remove (2x) M3 screws to remove the Docking latch bracket.



5. Remove (1x) screw from front side of the Docking Bracket



6. Remove (2x) screws from rear side

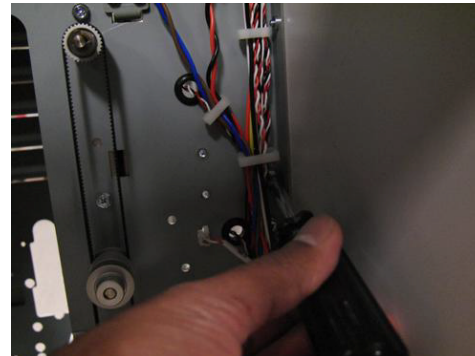

7. Remove the Docking Bracket.

Installation Procedure

1. Place the Docking Bracket in position and tighten the (2x) screws at the rear side of the Docking Bracket.
2. Tighten the (1x) screw at front side of the Docking Bracket
3. Place the Docking latch bracket and tighten (2x) screws.
4. Do GP 6.3 Dock the Punch to connect the Punch to the upstream and downstream devices.
5. Connect the Power Cord.
6. Power ON the entire printing system.

REP 1.18 Exhaust Fan Replacement

PARTS LIST ON PL 2.2

Use this procedure to remove and install the Exhaust Fan.

Removal Procedure

WARNING

Do not perform repair activities with the power on or electrical power supplied to the machine. Some machine components contain dangerous electrical voltages that can result in electrical shock and possible serious injury. See Section 0, page vi for other languages.

1. Switch power OFF to entire printing system.
2. Disconnect the Power Cord.
3. Do REP 1.6 to remove the Rear Cover.
4. Remove the Screws (2) and the Exhaust Fan Bracket.

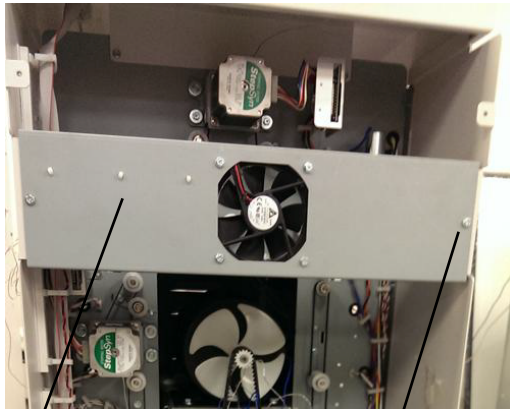

Exhaust Fan Bracket

Screws (2)

5. Do the following to remove the Exhaust Fan from the Exhaust Fan Bracket.

- Disconnect Cable 7715267 at Connector J20 on the Control Board (PL 7.1 and PL 7.4).



Nuts (4)

- Open the Wires Saddles.
- Remove the Screws (4) from the front and the Nuts (4) from the rear of the Bracket.
- Remove the Exhaust Fan.

Installation Procedure

1. Do the following to install the Exhaust Fan on the Exhaust Fan Bracket.
 - Place the new Exhaust Fan in position on the Exhaust Fan Bracket. The arrow on the Fan housing indicates the direction of air flow. The air flow direction is pointing out, air flowing out of the machine.

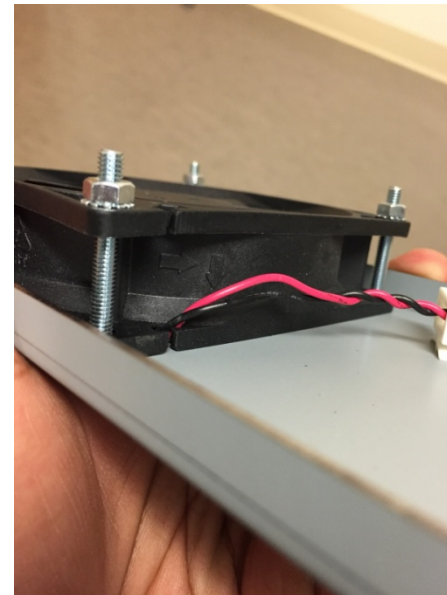

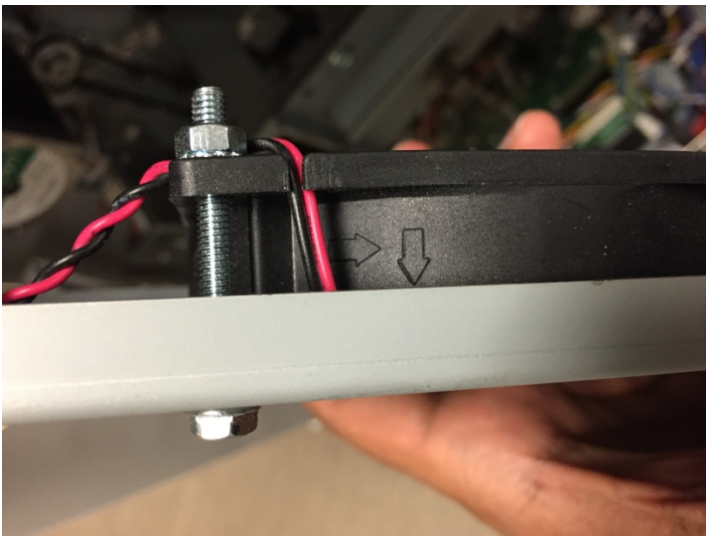

2. Place the Exhaust Fan Bracket Assembly in position and tighten the Screws (2).
3. Connect Cable 7715267 at Connector J20 on the Control Board (7.1).
4. Do REP 1.6 to install the Rear Cover.
5. Connect the Power Cord.
6. Power ON the entire printing system.

- Connect Cable 7715267 at Connector J20 on the Control Board (PL 7.1 and PL 7.4).
- Install the Screws (4) from the front and tighten the Nuts (4) from the rear of the Bracket.
- Place Cable 7715267 into the Wires Saddles.

REP 1.19 Drive roller Cover removal.

Use this Procedure to remove the Drive roller cover from entrance and exit sides.

Removal Procedure

WARNING

Do not perform repair activities with the power on or electrical power supplied to the machine. Some machine components contain dangerous electrical voltages that can result in electrical shock and possible serious injury. See Section 0, page vi for other languages.

1. Switch power OFF to entire printing system.
2. Disconnect the Power Cord.
3. Do REP 1.6 to remove the Rear Cover.
4. For Entrance side- Remove (2) screws from the front frame and (2) screws from the rear frame.

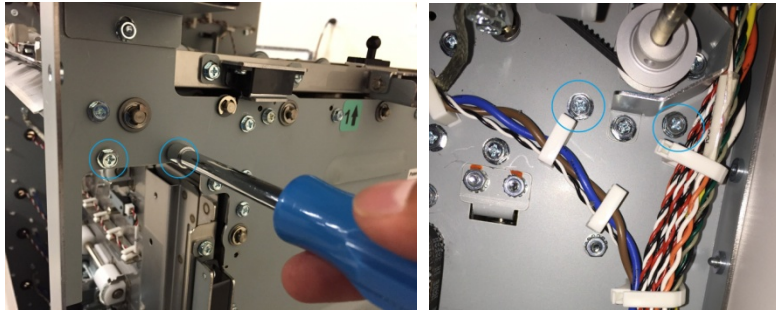

5. For exit side- Remove (2) screws from the front frame and (2) screws from the rear frame.

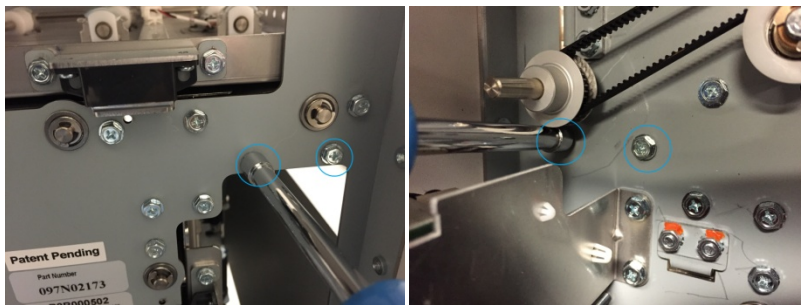

6. Remove the Drive roller cover.

2. Paper Path

REP 2.1 Lower Entrance Panel Replacement

PARTS LIST ON PL 3.1

Use this procedure to remove and install the Lower Entrance Panel.

Removal Procedure

WARNING

Do not perform repair activities with the power on or electrical power supplied to the machine. Some machine components contain dangerous electrical voltages that can result in electrical shock and possible serious injury. See Section 0, page vi for other languages.

1. Switch power OFF to entire printing system.
2. Disconnect the Power Cord.
3. Do GP 6.4 to undock the Punch from the upstream and downstream equipment.
4. Do REP 1.6 Rear Cover Replacement to remove the Rear Cover.
5. Do REP 1.20 to remove the Entrance side Drive roller cover.
6. Open the Upper Bypass Assembly.
7. Remove the Screws (2) from the Front Frame used to mount the Lower Entrance Panel.

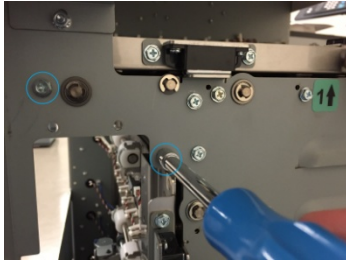

8. Remove the Timing belt pulley shield by removing (1) screw and (1) nut from the Rear Frame.

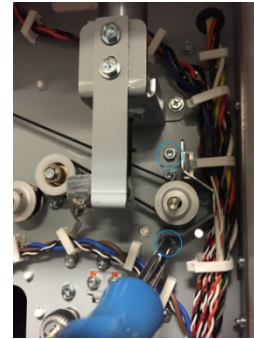

9. Remove the Screws (2) from the Rear Frame used to mount the Lower Entrance Panel.



10. Remove the Lower Entrance Panel.

Installation Procedure

1. Place the Lower Entrance Panel in position.
2. Tighten the Screws (4) used to mount the Lower Entrance Panel
3. Intall the Timing belt pulley shield with (1) screw and (1) nut.
4. Close the Upper Bypass Assembly.
5. Do REP 1.6 Rear Cover Replacement to install the Rear Cover.
6. Do GP 6.3 to dock the Punch to the upstream and downstream equipment.
7. Connect the Power Cord.
8. Power ON the entire printing system.
9. Do ADJ 1.2 Diverter Solenoid Adjustment.

REP 2.2 Entrance Idler Panel Replacement

PARTS LIST ON PL 3.1, PL 4.2

Use this procedure to remove and install the Entrance Idler Panel.

Removal Procedure

WARNING

Do not perform repair activities with the power on or electrical power supplied to the machine. Some machine components contain dangerous electrical voltages that can result in electrical shock and possible serious injury. See Section 0, page vi for other languages.

1. Switch power OFF to entire printing system.
2. Disconnect the Power Cord.
3. Open the Front Door.
4. Do GP 6.4 *Undock the Punch* to separate the Punch from the upstream and downstream devices.
5. Do REP 1.8 to remove the Upstream Side Cover.
6. Do REP 1.17 to remove the Docking Bracket.



Docking Bracket

7. Open the Cable Clamps to release all the sensor cables and disconnect S2, S3, S4 and S1b..

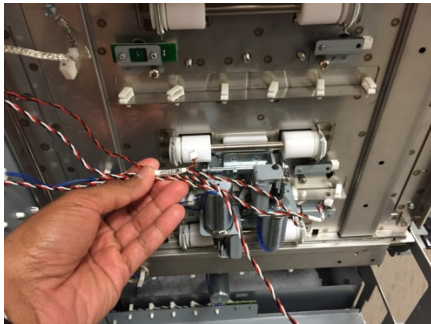

8. Remove the screw for the ground strap.
9. Disconnect the Connectors for Solenoids SOL3 & SOL4 from the header.

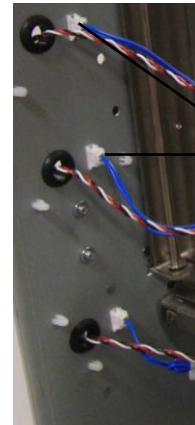

Solenoid SOL3 & SOL4 Connectors

10. Remove the M4 screw of the Ground strap.



11. Remove the E-Ring from the bottom of the Idler Panel Shaft.

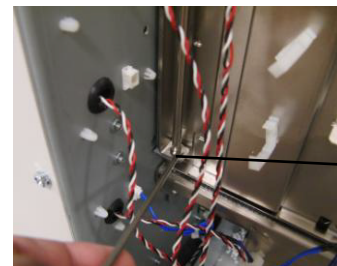

E-Ring

12. Remove the E-Ring from the top of the Idler Panel Shaft.

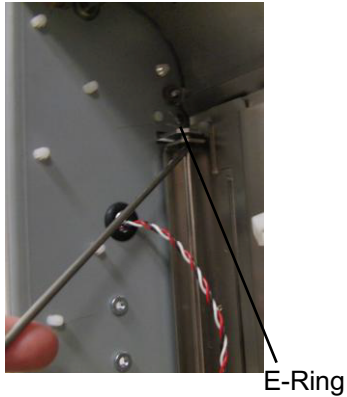

13. Open the Entrance Idler Panel from the front side.

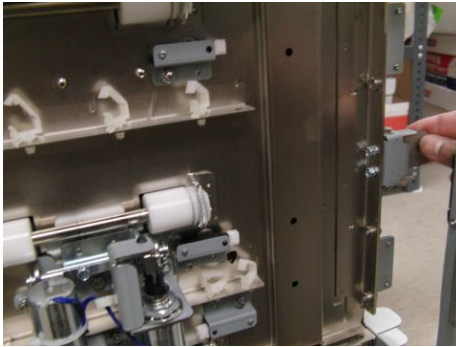

14. Carefully remove the Shaft.

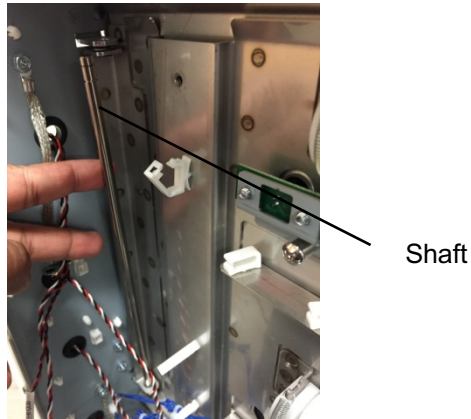

(Cont.)

15. Grasp the Entrance Idler Panel and remove it.



16. Do the following to transfer the Sensors, Solenoid Modules, Idler Rollers, Springs, and Panel Magents to the new weldment.

- REP 2.12 Idler Roller replacement
- REP 2.25.3 Paper path sensor (S2, S3, S4) Replacement
- REP 2.28.2 Disengaging Roller Solenoid Replacement

Installation Procedure

1. Place the Entrance Idler Panel in position.
2. Insert the Shaft through the holes (2) at the left side of the Entrance Idler Panel.
3. Install the E-Rings (2) at the top and bottom of the Shaft.
4. Connect the Connectors for Solenoids SOL3 & SOL4 to the header.
5. Connect the Connectors for Sensors S2, S3, S4 and S1b.
6. Place the sensor cables into the Cable Clamps, and close the Clamps.
7. Install the Ground strap.
8. Do ADJ 1.7 Idler Panel Magnetic Latches Adjustment.
9. Do REP 1.17 to install the Docking Bracket.
10. Do REP 1.8 to install the Side Cover.
11. Do GP 6.3 *Dock the Punch* to connect the Punch to the upstream and downstream devices.
12. Close the Front Door.
13. Connect the Power Cord.
14. Power ON the entire printing system.

REP 2.3 Acceleration Roller Idler Assembly Replacement

PARTS LIST ON PL 3.1 and PL 4.4

Do the following to replace the Acceleration Idler Roller Assembly (or the Accel Idler Panel Weldment).

Removal Procedure

1. Switch power OFF to entire printing system.
2. Disconnect the Power Cord.
3. Do GP 6.4 *Undock the Punch* to separate the Punch from the upstream and downstream devices.
4. Open the Front Door.



Acceleration Idler Roller Handle

5. Do REP 1.8 to remove the Upstream Side frame Cover.

6. Grasp the Handle and open the Acceleration Idler Roller Panel.



Acceleration Idler Roller Handle

7. Open the Cable Clamps to release the Sensor Cable.

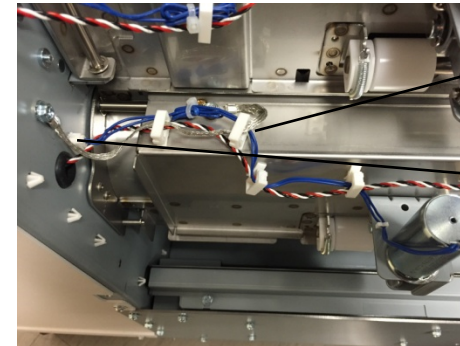

Cable Clamps

Solenoid SOL5
Connector

8. Disconnect the Accel Sensor S5 Connector.
9. Disconnect the Acceleration Idler Roller Solenoid SOL5 Connector at the sensor on the Acceleration Idler Roller Assembly.
10. Remove the screw for the Ground strap.



11. Remove the E-Ring (2) from each end of the Accel Idler Latch Shaft.

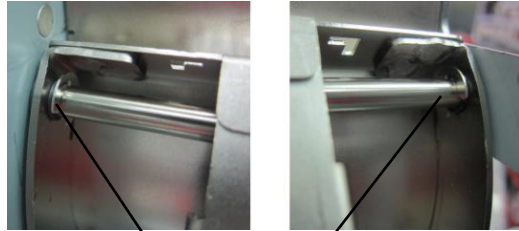

E-Ring

E-Ring

12. Remove the Accel Idler Latch Shaft.

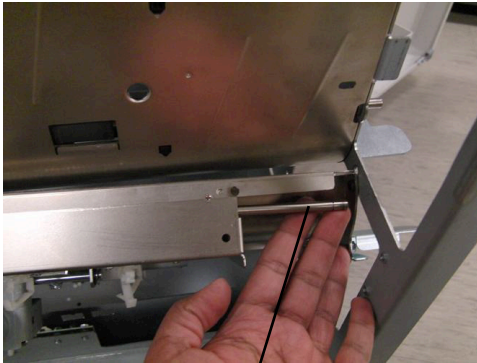

Shaft

13. Remove the Acceleration Idler Roller Assembly.



Acceleration Idler Roller Assembly

14. To replace the Accel Idler Panel Weldment do the following procedures to remove and install these components.

- REP 2.12 Acceleration Roller Idler Assembly Replacement
- REP 2.25.3 Accel Sensor (S5) Replacement
- REP 2.28.2 Disengaging Roller Solenoid Replacement

Installation Procedure

1. Place the Acceleration Idler Roller Assembly in position.
2. Slide the Accel Idler Latch Shaft through the holes in the frame and the holes at each end of the Acceleration Idler Roller Assembly.
3. Install the E-Ring (2) at each end of the Accel Idler Latch Shaft.
4. Connect the Acceleration Idler Roller Solenoid SOL5 Connector at the header.
5. Connect the Acccel Sensor S5 Connector.
6. Place the Cable in the cable Clamps and close the cable Clamps.
7. Grasp the Handle and close the Acceleration Idler Roller Panel.
8. Do REP 1.8 to install the Upstream Side frame Cover.
9. Close the Front Door.
10. Do GP 6.3 *Dock the Punch* to connect the Punch to the upstream and downstream devices.
11. Connect the Power Cord.
12. Power ON the entire printing system.

REP 2.4 Entrance Drive Panel Assembly Replacement

PARTS LIST ON PL 3.1, PL 4.1

Use this procedure to remove and install the Entrance Drive Panel Assembly.

Removal Procedure

WARNING

Do not perform repair activities with the power on or electrical power supplied to the machine. Some machine components contain dangerous electrical voltages that can result in electrical shock and possible serious injury. See Section 0, page vi for other languages.

1. Switch power OFF to entire printing system.
2. Disconnect the Power Cord.
3. Do REP 1.6 to remove the Rear Cover.



4. Do REP 3.1 to remove the Punch Module.

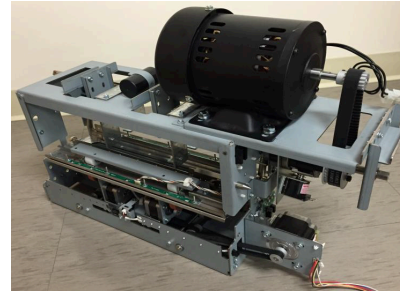

5. Do GP 6.4 *Undock the Punch* to separate the Punch from the upstream and downstream devices.
6. Do REP 1.8 to remove the Side Cover.
7. Do REP 1.17 to remove the Docking Bracket.



Docking Bracket

8. Do REP 2.2 to remove the Entrance Idler Panel.

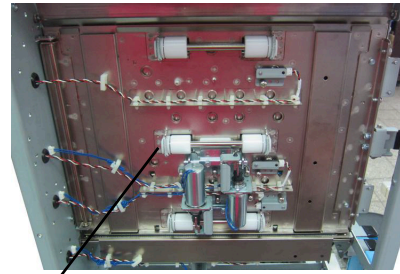

Entrance Idler Panel

(Cont.)

9. Do REP 2.3 to remove the Acceleration Idler Roller Panel.



Acceleration Roller Idler Assembly

10. Unhook the Acceleration Panel Latch Springs (2).

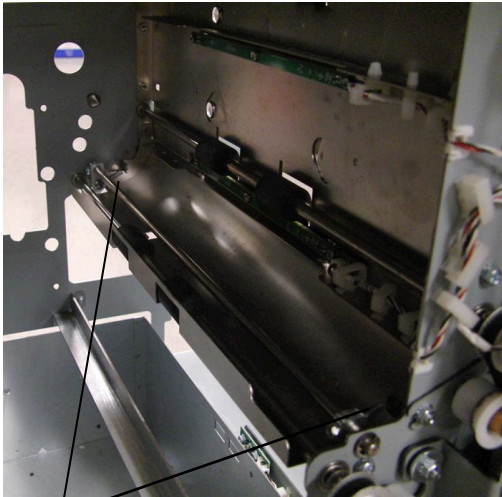

Acceleration Panel Latch Springs

11. Unhook the Springs (2) from the Idler panel side.

12. Do REP 2.22.1 to remove the Drive Roller for Roller N5.

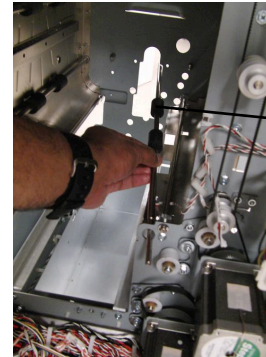

Drive Roller

13. Open the Cable Clamps and release the Sensor Cables.

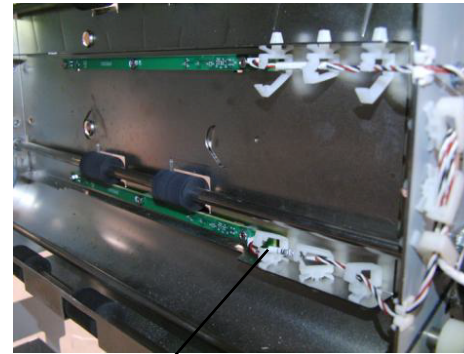

Cable Clamps

14. Disconnect the Sensor Board Connectors (2) and the Clear Cover Sensor.



Sensor Board Connectors

(Cont.)

15. Remove the Screws (5) that hold the Entrance Drive Panel to the front Frame.



Screws (5)

Entrance Drive Panel

16. Remove the Screws (5) that hold the Entrance Drive Panel to the Rear Frame.

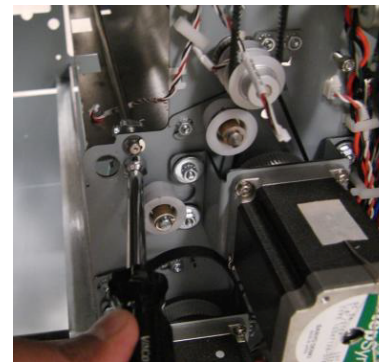
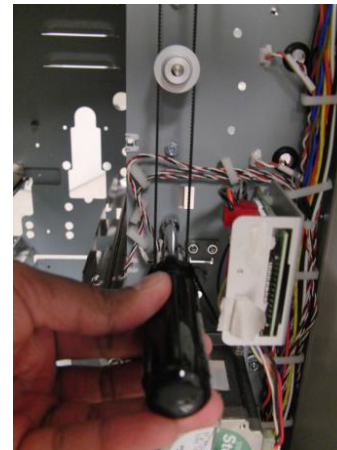
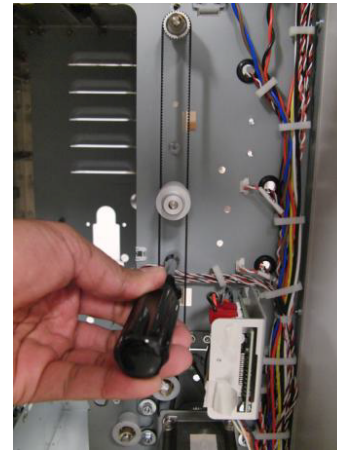
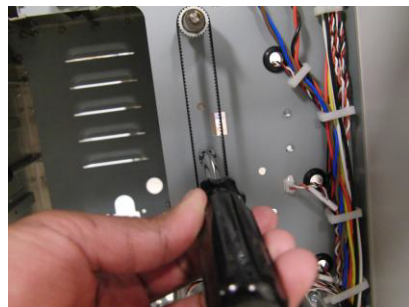
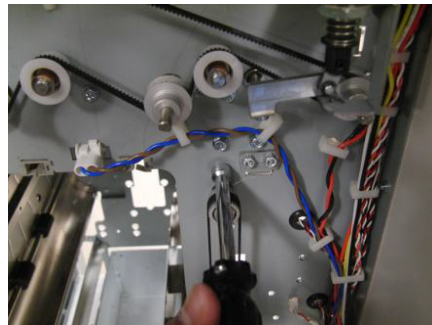

17. If you cannot remove the Entrance Drive Panel, remove the Idler Panel Mount Bracket from the lower position only.

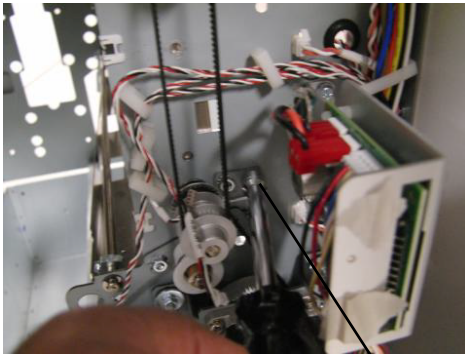

Idler Panel Mount Bracket

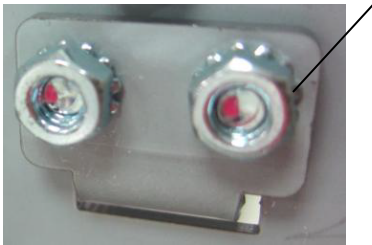

18. Remove the Entrance Drive Panel.
19. Transfer the sensor Boards and the Clear Cover Sensor to the new Panel Weldment.

Installation Procedure

Do the following to install the Entrance Drive Panel.

1. Place the Entrance Drive Panel in position.
2. Install the Idler Panel Mount Bracket at the lower position with (2) M4 nuts.
3. Install the Screws (5) that hold the Entrance Drive Panel to the rear Frame.
4. Install the Screws (5) that hold the Entrance Drive Panel to the front Frame.
5. Connect the Sensor Board Connectors (2).
6. Place the Sensor Cables in the Cable Clamps and close the Cable Clamps.
7. Do REP 2.22.1 to install the Drive Roller for Roller N5.
8. Hook the Acceleration Panel Latch Springs (2) to the Idler Panel side.
9. Do REP 2.3 to install the Acceleration Idler Roller Panel.
10. Do REP 2.2 to install the Entrance Idler Panel.
11. Do REP 1.17 to install the Docking Bracket.
12. Do REP 1.8 to install the Side Cover.
13. Do REP 3.1 to install the Punch Module.
14. Do ADJ 1.8 Drive Panel Position Adjustment.
15. Do REP 1.6 to install the Rear Cover.
16. Connect the Power Cord.
17. Power ON the entire printing system.

REP 2.5 Punch Lower Exit Panel Replacement

PARTS LIST ON PL 3.1

Use this procedure to remove and install the Lower Exit Panel.

Removal Procedure

WARNING

Do not perform repair activities with the power on or electrical power supplied to the machine. Some machine components contain dangerous electrical voltages that can result in electrical shock and possible serious injury. See Section 0, page vi for other languages.

1. Switch power OFF to entire printing system.
2. Disconnect the Power Cord.
3. Do REP 1.11 to remove Lower downstream Side frame cover.
4. Remove the screw for Ground strap.
5. Open the Front Door.

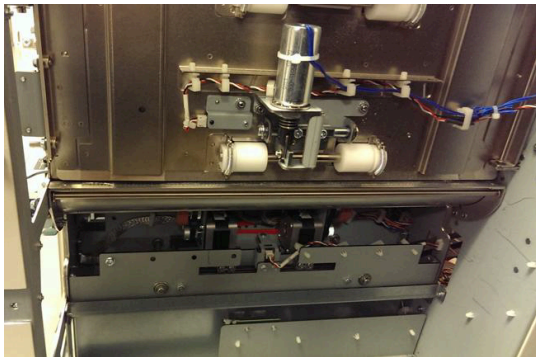

6. Remove the E-clips (2) from the Shaft.



7. Remove the M4 screw for the ground strap.

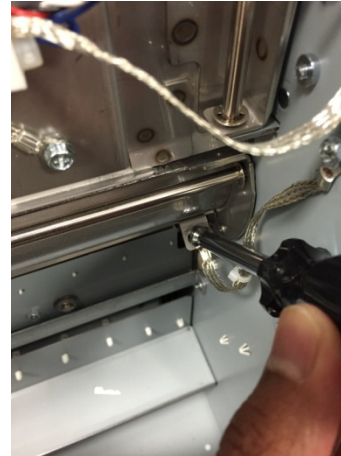

8. Slide the Shaft out of place.
9. Remove the Lower Exit Panel.



Installation Procedure

1. Place the Lower Exit Panel in position.
2. Slide the Shaft into place.
3. Install the E-clips (2) on the ends of the Shaft.
4. Close the Front Door.
5. Connect the Power Cord.
6. Power ON the entire printing system.

REP 2.6 Exit Idler Panel Replacement PARTS LIST ON PL 3.1 and PL 4.4

Use this procedure to remove and install the Exit Idler Panel.

Removal Procedure

WARNING

Do not perform repair activities with the power on or electrical power supplied to the machine. Some machine components contain dangerous electrical voltages that can result in electrical shock and possible serious injury. See Section 0, page vi for other languages.

1. Switch power OFF to entire printing system.
2. Disconnect the Power Cord.
3. Open the Front Door.
4. Do GP 6.4 *Undock the Punch* to separate the Punch from the downstream devices.
5. Do REP 1.11 to remove the Lower Downstream Side Frame Cover.
6. Open the Cable Clamps to release all the sensor cables.

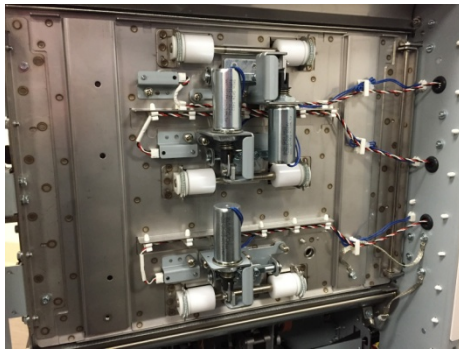

7. Disconnect the Connectors for Sensors S22, S23, & S24.

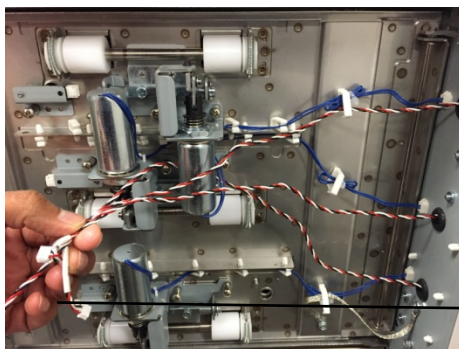

Sensor S22, S23, & S24
Connectors

8. Disconnect the Connectors for Solenoids SOL6, SOL7, & SOL8 from the header.

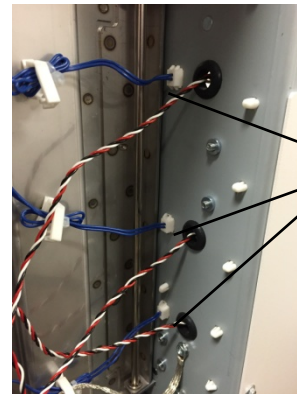

Solenoid SOL6,
SOL7 & SOL8
Connectors

9. Remove the M4 screw for ground strap.

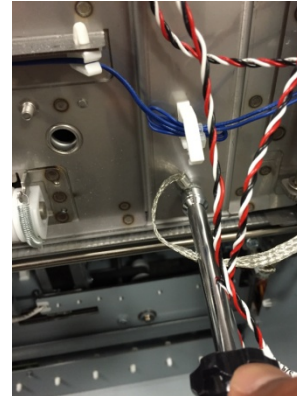

10. Remove the E-Ring from the bottom of the Idler Panel Shaft.



E-Ring

11. Remove the E-Ring from the top of the Idler Panel Shaft.

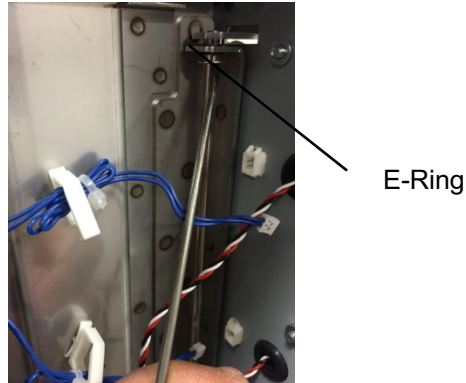

12. Open the Entrance Idler Panel from the front side.
13. Carefully remove the Shaft.

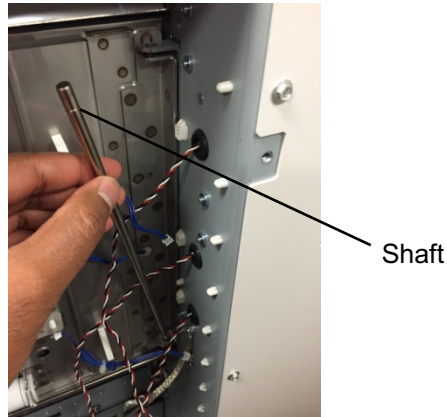

14. Grasp and remove the Exit Idler Panel.

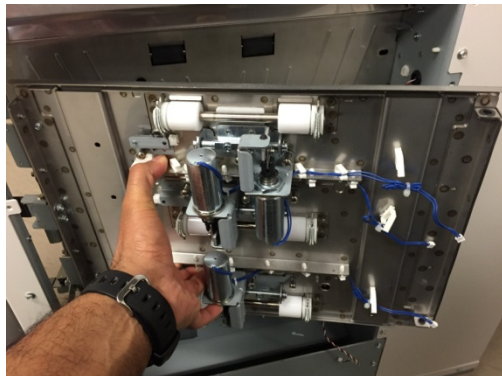

15. To replace the Exit Idler Panel Weldment do the following procedures to remove and install these components.
- REP 2.12 Idler Roller Replacement
 - REP 2.25.2 Top, Middle, & Bottom Exit Sensor (S22, S23, S24) Replacement
 - REP 2.28.4 Exit Idler Solenoid Replacement
 - REP 2.11 Panel Close Magnet Replacement

Installation Procedure

1. Place the Exit Idler Panel in position.
2. Insert the Shaft through the holes (2) at the left side of the Exit Idler Panel.
3. Install the E-Rings (2) at the top and bottom of the Shaft.
4. Connect the Connectors for Solenoids SOL5, SOL6 & SOL7 to the header.
5. Connect the Connectors for Sensors S22, S23, & S24.
6. Install the Ground strap.
7. Place the sensor cables into the Cable Clamps, and close the Clamps
8. Do REP 1.11 to install the Downstream Side Frame Cover.
9. Do GP 6.3 *Dock the Punch* to connect the Punch to the downstream devices.
10. Close the Front Door.
11. Connect the Power Cord.
12. Power ON the entire printing system.

REP 2.7 Drive Exit Panel Replacement

PARTS LIST ON PL 3.1

Use this procedure to remove and install the Drive Exit Panel.

Removal Procedure

WARNING

Do not perform repair activities with the power on or electrical power supplied to the machine. Some machine components contain dangerous electrical voltages that can result in electrical shock and possible serious injury. See Section 0, page vi for other languages.

1. Switch power OFF to entire printing system.
2. Disconnect the Power Cord.
3. Do GP 6.4 to undock the Punch from the upstream and downstream equipment.
4. Do REP 1.11 Downstream Side Frame Cover Replacement remove the Downstream Side Frame Cover.
5. Do REP 2.5 to remove the Punch Lower Exit Panel.
6. Do REP 2.6 to remove the Exit Idler Panel.
7. Remove (3) M4 nuts to remove the Bracket in Area 5 of the machine.



8. Do REP 2.23 to remove Motor M7 by removing (4) screws.



9. Remove the Timing Belt Tensioner Assembly of Motor M6 by removing (2) nuts.

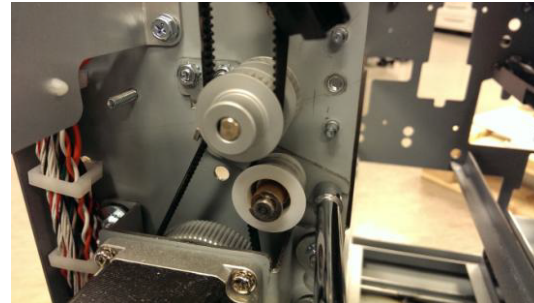

10. Remove (4) screws from the front frame and (4) screws from the rear frame to remove the Drive Exit Panel.

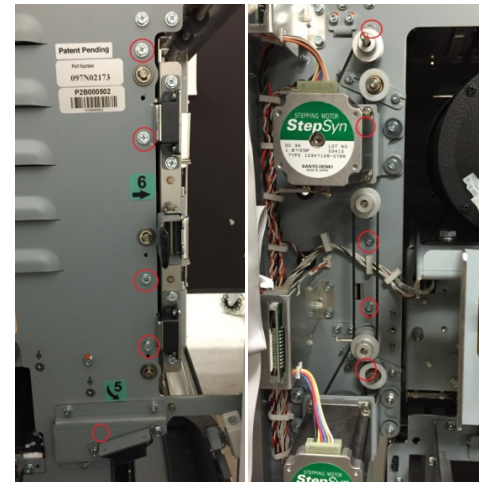

11. Remove the Drive Exit Panel.

Installation Procedure

1. Place the Drive Exit Panel in position.
2. Install the new Drive exit panel, by installing the (4) screws in the front frame and (4) screws in the rear frame.
3. Do ADJ 1.8 Drive Panel Position Adjustment
4. Place the Timing Belt Tensioner Assembly of Motor M6 in position and tighten the (2) nuts.
5. Do REP 2.23 to install Motor M7.
6. Place the Bracket in position in Area 5 of the machine, and tighten the (3) M4 nuts.
7. Do REP 2.6 to install the Exit Idler Panel.
8. Do REP 2.5 to install the Punch Lower Exit Panel.
9. Do ADJ 1.7 Idler Panel Magnetic Latches Adjustment.
10. Do REP 1.11 Downstream Side Frame Cover Replacement install the Downstream Side Frame Cover.
11. Do GP 6.4 to dock the Punch to the upstream and downstream equipment.
12. Connect the Power Cord.
13. Power ON the entire printing system.

REP 2.8 Lower Exit Panel Replacement

PARTS LIST ON PL 3.1

Use this procedure to remove and install the Lower Exit Panel

Removal Procedure

1. Switch power OFF to entire printing system.
2. Disconnect the Power Cord.
3. Do GP 6.4 to undock the Punch from the upstream and downstream equipment.
4. Do REP 1.6 Rear Cover Replacement to remove the Rear Cover.
5. Do REP 1.11 Downstream Side Frame Cover Replacement to remove the upper and lower Downstream Side Frame Cover.
6. Remove the Screws (2) from the Front Frame and the Screws (2) from the Rear Frame used to mount the Lower Exit Panel.

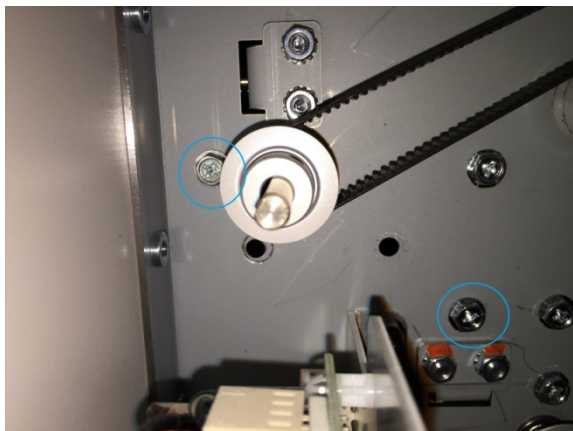
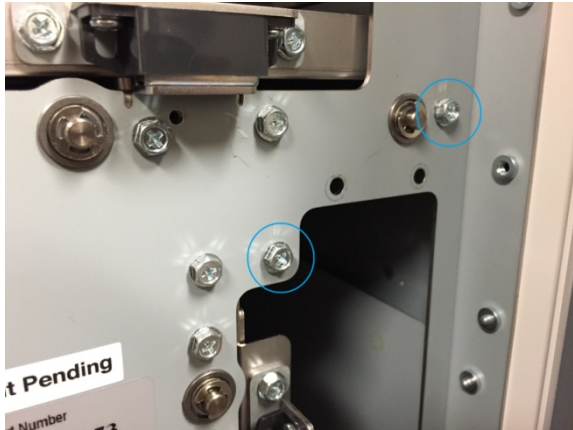

7. Open the Upper Bypass Assembly.



8. Remove the Lower Exit Panel.

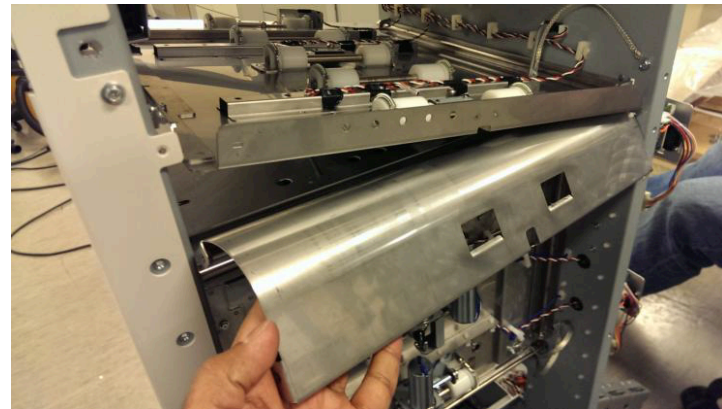

Installation Procedure

1. Place the Lower Exit Panel in position.
2. Tighten the Screws (4) used to mount the Inner Entrance Panel.
3. Do REP 1.11 Downstream Side Frame Cover Replacement to install the upper and lower Downstream Side Frame Cover.
4. Do REP 1.6 Rear Cover Replacement to install the Rear Cover.
5. Do GP 6.3 to dock the Punch to the upstream and downstream equipment.
6. Connect the Power Cord.
7. Power ON the entire printing system.

REP 2.9 Upper Bypass Panel Replacement

PARTS LIST ON PL 3.1 and PL 4.5

Use this procedure to remove and install the Upper Bypass Panel.

Removal Procedure

WARNING

Do not perform repair activities with the power on or electrical power supplied to the machine. Some machine components contain dangerous electrical voltages that can result in electrical shock and possible serious injury. See Section 0, page vi for other languages.

1. Switch power OFF to entire printing system.
2. Disconnect the Power Cord.
3. Do GP 6.4 to undock the Punch from the upstream and downstream equipment.
4. Do REP 1.6 Rear Cover Replacement to remove the Rear Cover.
5. Unplug the Sensors from the Upper Bypass Panel and release the sensor cables from the cable clamps.

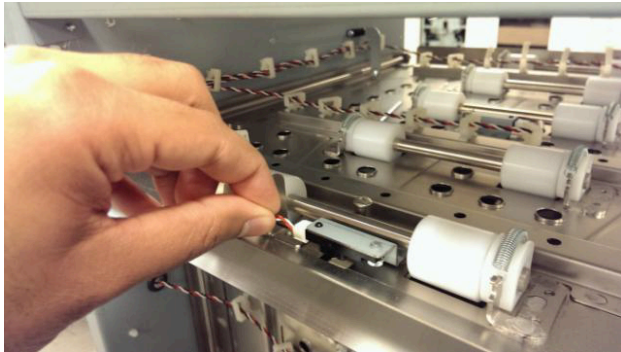

6. Remove (2) E-clips from the hinge shaft and remove the shaft.



7. Remove the Idler Panel Mount Brackets (2) from the rear frame.



8. Remove (2) Idler panel magnetic latches from the Upper bypass assembly by unscrewing (4) screws.



9. Remove the Handle assembly by removing (2) screws.



10. Remove the Upper Bypass Assembly.

Installation Procedure

1. Transfer the Idler rollers, springs, sensors, Bypass Open sensor flag, Magnetic latches to the new part.
2. Place the Upper Bypass Assembly.in position.
3. Install the the Handle Assembly.
4. Install the (2) Idler panel magnetic latches.
5. Install the Idler Panel Mount Brackets (2) on the rear frame.
6. Place the Shaft in position and install the (2) E-clips.
7. Connect the Sensors from the Upper Bypass Panel and place the sensor cables in the cable clamps.
8. Do REP 1.6 Rear Cover Replacement to install the Rear Cover.
9. Do GP 6.3 to dock the Punch to the upstream and downstream equipment.
10. Connect the Power Cord.
11. Power ON the entire printing system.
12. Do ADJ 1.7 Idler Panel Magnetic Latches adjustment.

REP 2.10 Lower Bypass panel replacement

PARTS LIST ON PL 3.1

Use this procedure to remove and install the Lower Bypass panel.

Removal Procedure

WARNING

Do not perform repair activities with the power on or electrical power supplied to the machine. Some machine components contain dangerous electrical voltages that can result in electrical shock and possible serious injury. See Section 0, page vi for other languages.

1. Switch power OFF to entire printing system.
2. Disconnect the Power Cord.
3. Do REP 2.9 Upper bypass removal.
4. Remove (4) M4 screws from Front frame.

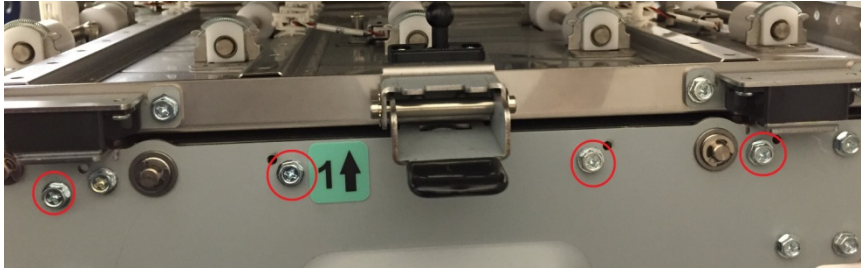

5. Remove (4) M4 screws from Rear frame.

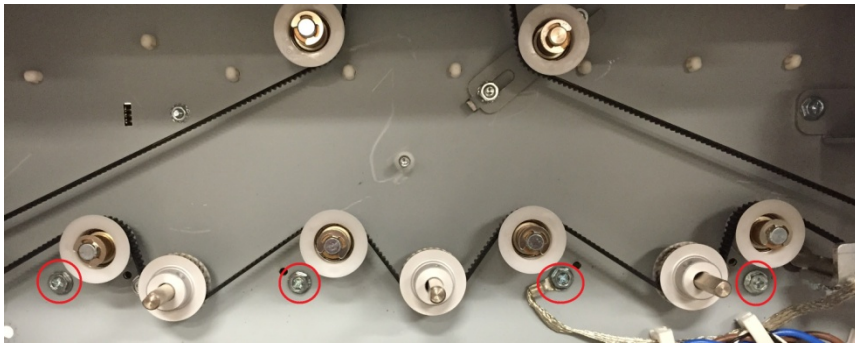

6. Remove the Lower Bypass panel.

Installation Procedure

1. Place the new Lower Bypass panel in position
2. Install (4) M4 screws through the Front frame and (4) screws through the Rear frame.

3. Do ADJ 1.8 to adjust the Drive panel position.
4. Do REP 2.9 to install the Upper Bypass panel.

REP 2.11 Panel Close Magnet Replacement

PARTS LIST ON PL 3.2

Use this procedure to remove and install the Magnet and Magnet Bracket for the Entrance Idler Panel, the Exit Idler Panel, or the Upper Bypass Panel.

WARNING

Do not perform repair activities with the power on or electrical power supplied to the machine. Some machine components contain dangerous electrical voltages that can result in electrical shock and possible serious injury. See Section 0, page vi for other languages.

1. Switch power OFF to entire printing system.
2. Disconnect the Power Cord.
3. Remove the Screws (2) and Nuts (2).
4. Remove the Magnet Bracket.
5. Remove the old Magnet.

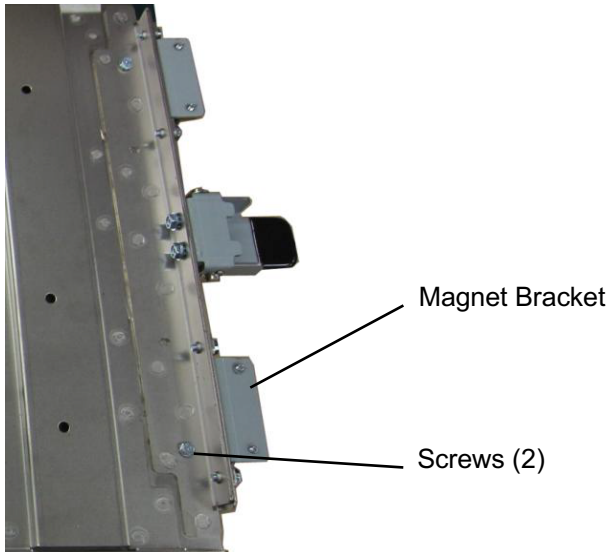

1. Place the Magnet Bracket in position and insert the Screws.
2. Do ADJ 1.7 Idler Panel Magnetic Latches Adjustment.



3. Connect the Power Cord.
4. Power ON the entire printing system.

REP 2.12 Idler Roller Replacement

PARTS LIST ON PL 4.2, PL 4.3, PL 4.4, PL 4.5

Use this procedure to remove and install the Idler Rollers or the Retaining Springs in these assemblies:

- Entrance Idler Panel.
- Acceleration Roller Idler Assy.
- Exit Idler Panel.
- Bypass Panel

Removal Procedure

WARNING

Do not perform repair activities with the power on or electrical power supplied to the machine. Some machine components contain dangerous electrical voltages that can result in electrical shock and possible serious injury. See Section 0, page vi for other languages.

1. Switch power OFF to entire printing system.
2. Disconnect the Power Cord.
3. Do the following to access the Idler Rollers.
 - For the Idler Rollers in the Entrance Idler Panel, do REP 1.8 to remove the Upstream Side Frame Cover.
 - For the Idler Rollers in the Acceleration Roller Idler Assembly, do do REP 1.8 to remove the Upstream Side Frame Cover.
 - For the Idler Rollers in the Exit Idler Panel, do REP 1.11 to remove the Downstream Side Frame Cover.
 - For the Idler Rollers in the Bypass Panel, Open the Front Door.

4. Lift the Extension Spring (2) up off the Bearing Housing (2) at each end of the Idler Roller Shaft.

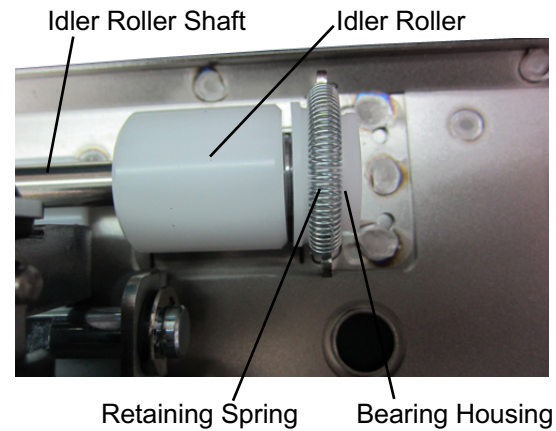

5. Remove the Idler Roller with the Bearing Housings (2) from the Bushing Forks.



6. Remove the Bearing Housing (2) at each end of the Idler Roller Shaft.



(Cont.)

Installation Procedure

1. Place the Bearing Housings (2) on the ends of the Idler Roller Shaft.
2. Place the new Idler Roller with the Bearing Housings (2) into the Bushing Forks.



3. Make sure the flat surface of the bushing aligns in the fork.
4. Rollers are non-directional so it does not matter which end goes in each fork.
5. After the assembly is in place, gently pull the assembly outward and release to ensure it moves freely in the fork.
6. Place the Extension Spring (2) over the Bearing Housings (2).
7. Place the hooks on the ends of the Extension Springs (2) on the notches at the top of the Bushing Forks (2).
8. Do the following to install the covers.
 - For the Idler Rollers in the Exit Idler Panel, do do REP 1.8 to remove the Upstream Side Frame Cover.
 - For the Idler Rollers in the Acceleration Roller Idler Assembly, do REP 1.8 to remove the Upstream Side Frame Cover.
 - For the Idler Rollers in the Exit Idler Panel, do REP 1.11 to install the Downstream Rear Side Cover.
 - For the Idler Rollers in the Bypass Panel, lower the Bypass Panel and close the Front Door.
9. Connect the Power Cord.
10. Power ON the entire printing system.

REP 2.13 Flange Ball Bearing Replacement

PARTS LIST ON PL 3.4

Use this procedure to remove and install a Flange Ball Bearing Part # 013N13948 or 013N13946).

1. Switch power OFF to entire printing system.
2. Disconnect the Power Cord.
3. Locate the Flange Ball Bearing.

7. Place the new Flange Ball Bearing in position.
8. Install the Flat Washer.
9. Install the E-Ring.
10. Connect the Power Cord.
11. Power ON the entire printing system.

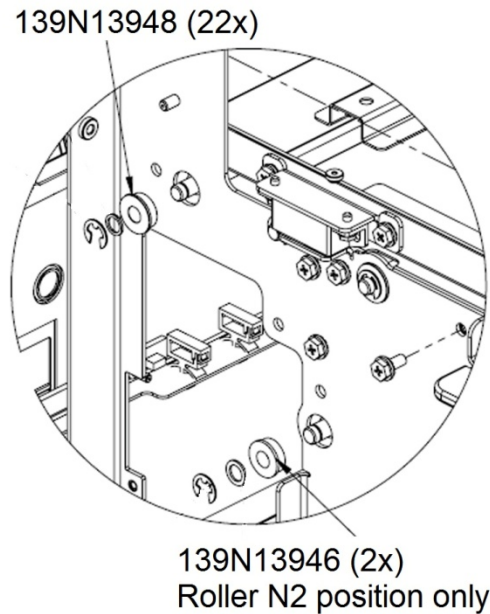

- There are 22 Flange Ball Bearings (Pt # 013N13948) on the Frame (PL 3.4).
 - There are 2 Flange Ball Bearings (Pt # 013N13946) on the Frame (PL 3.4).
4. Remove the E-Ring.
 5. Remove the Flat Washer.
 6. Remove the Flange Ball Bearing.

NOTE: To replace a Bearing from the rear side, do REP 2.20 to remove the Pulley.

REP 2.14 Snap-in Bearing Replacement

PARTS LIST ON PL 3.1 and PL 3.2

Use this procedure to remove and install a Snap-in Bearing, located in one of the following assemblies.

- Entrance Idler Panel (PL 4.2)
- Acceleration Roller Idler Assembly (PL 4.3)
- Upper Bypass Panel (PL 4.5)
- Exit Idler Panel (PL 4.4)
- Lower Exit Panel (PL 3.1)

WARNING

Do not perform repair activities with the power on or electrical power supplied to the machine. Some machine components contain dangerous electrical voltages that can result in electrical shock and possible serious injury. See Section 0, page vi for other languages.

1. Switch power OFF to entire printing system.
2. Disconnect the Power Cord.
3. Do one of the following to remove the panel so you can access the Snap-in Bearing.
 - REP 2.2 Entrance Idler Panel Replacement
 - REP 2.3 Acceleration Roller Idler Assembly Replacement
 - REP 2.9 Upper Bypass Panel Replacement
 - REP 2.6 Exit Idler Panel Replacement
 - REP 2.5 Punch Lower Exit Panel Replacement

4. Remove the Snap-in Bearing.
5. Place the new Snap-in Bearing in position.
6. Do one of the following to install the panel.
 - REP 2.2 Entrance Idler Panel Replacement
 - REP 2.3 Acceleration Roller Idler Assembly Replacement
 - REP 2.9 Upper Bypass Panel Replacement
 - REP 2.6 Exit Idler Panel Replacement
 - REP 2.5 Lower Exit Panel Replacement
7. Connect the Power Cord.
8. Power ON the entire printing system.

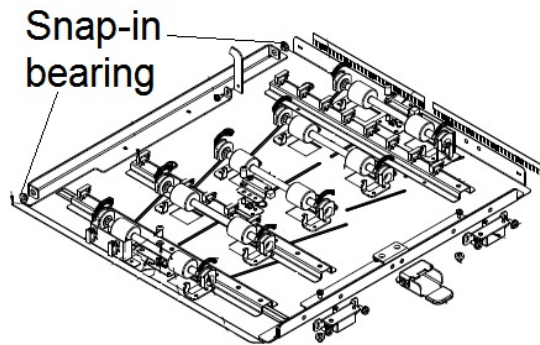

REP 2.15 Bearing Housing Replacement

PARTS LIST ON PL 4.2, PL 4.3, PL 4.4, PL 4.5

Use this procedure to remove and install the Bearing Housings for the Idler Rollers in these assemblies:

- Entrance Idler Panel.
 - Acceleration Roller Idler Assy.
 - Exit Idler Panel.
 - Bypass Panel
1. Do REP 2.12 to remove the Idler Roller with the Bearing Housings (2) from the Bushing Forks.

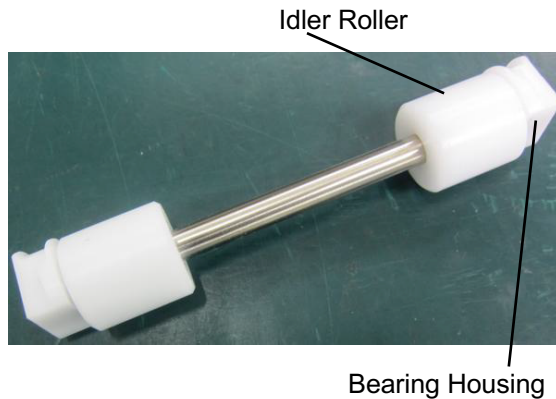

2. Remove the old Bearing Housings (2) from the ends of the Shaft.



3. Place the new Bearing Housings (2) on the ends of the Shaft with the flange of the Bearing facing in toward the Idler Roller.

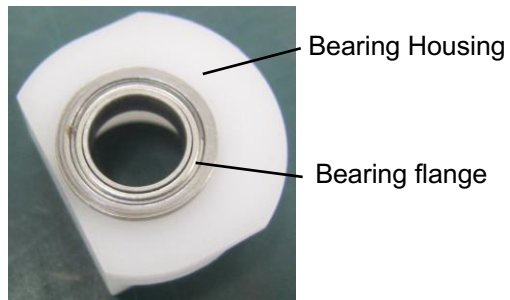

4. Do REP 2.12 to install the Idler Roller.

REP 2.16 Accel Idler Latch Handle Replacement

PARTS LIST ON PL 3.2

Use this procedure to remove and install the Accel Idler Latch Handle or the Accel Idler Shaft.

Removal Procedure

WARNING

Do not perform repair activities with the power on or electrical power supplied to the machine. Some machine components contain dangerous electrical voltages that can result in electrical shock and possible serious injury. See Section 0, page vi for other languages.

1. Switch power OFF to entire printing system.
2. Disconnect the Power Cord.
3. Open the Front Door.
4. Remove (2) screws from the Accel Idler Latch Handle.



5. Remove the Rubber Cap and transfer it to the new part, if re-using the rubber cap. If a new Rubber cap has been ordered, use the new part.



Installation Procedure

1. Place the Accel Idler Latch Handle in position and tighten the Screws (2).
2. Close the Front Door.
3. Connect the Power Cord.
4. Power ON the entire printing system.

REP 2.17 Accel Idler Latch Shaft, Rear Latch and Front Latch Assembly Replacement

PARTS LIST ON PL 3.5

Use this procedure to remove and install one or more of the following:

- Accel Idler Latch Shaft
- Accel Idler Panel Rear Latch Assembly
- Accel Idler Panel Front Latch Assembly

Removal Procedure

1. Switch power OFF to entire printing system.
2. Disconnect the Power Cord.
3. Do REP 1.6 to remove the Rear Cover.
4. Do REP 3.1.1 to remove the Punch Module.
5. Unhook the Extension Springs from the Accel Idler Panel Front and Rear Latches.



6. Remove the M3 screws (2) from the Accel Idler Panel Front and Rear Latches.

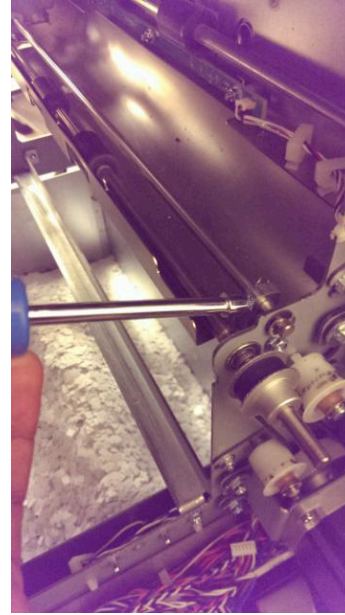

7. Remove the E-clip from the Accel Idler Shaft on the rear side.



8. Do REP 2.16 to remove the Accel Idler Latch Handle.
9. Remove the E-clip from the Accel Idler Shaft on the front side.



11. For the Accel Idler Panel Front Latch Assembly, slide the shaft towards the rear side to remove.

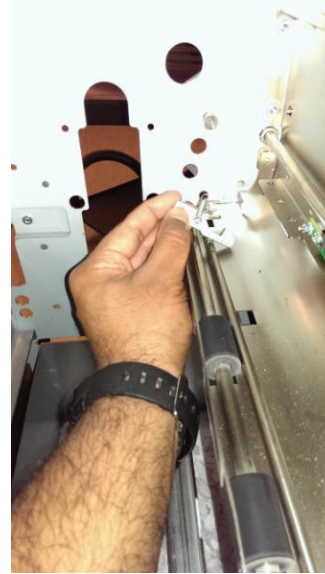

10. For the Accel Idler Panel Rear Latch Assembly, slide the shaft towards the front side to remove.

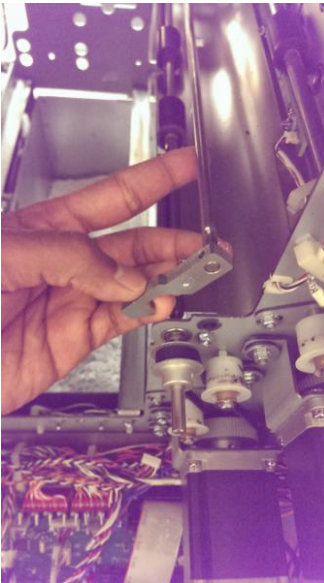

12. Remove Accel Panel Rear and Front Latch assemblies to remove the Accel Idler Latch shaft.



Installation Procedure

1. Place the Accel Panel Rear and Front Latch Assemblies in position to install the Accel Idler Latch Shaft.
2. For the Accel Idler Panel Front Latch Assembly, slide the shaft towards the front side to install.
3. For the Accel Idler Panel Rear Latch Assembly, slide the shaft towards the rear side to install.
4. Install the E-clip on the Accel Idler Shaft from the front side.
5. Do REP 2.16 to install the Accel Idler Latch Handle.
6. Install the E-clip on the Accel Idler Shaft from the rear side.
7. Install the M3 screws (2) in the Accel Idler Panel Front and Rear Latches.
8. Hook the Extension Springs to the Accel Idler Panel Front and Rear Latches.
9. Do REP 3.1.2 to install the Punch Module.
10. Do REP 1.6 to install the Rear Cover.
11. Connect the Power Cord.
12. Power ON the entire printing system.

REP 2.18 One Way Clutch and Pulley Sub-Assembly Replacement PARTS LIST ON PL 3.4

Use this procedure to remove and install the One Way Clutch and Pulley Sub-Assembly.

WARNING

Do not perform repair activities with the power on or electrical power supplied to the machine. Some machine components contain dangerous electrical voltages that can result in electrical shock and possible serious injury. See Section 0, page vi for other languages.

1. Switch power OFF to entire printing system.
2. Disconnect the Power Cord.
3. Do REP 1.6 Rear Cover Replacement to remove the Rear Cover.
4. Remove the E-Clip and Washer.
5. Slide the old One Way Clutch Assembly off the Shaft, while leaving the Timing Belt in place.

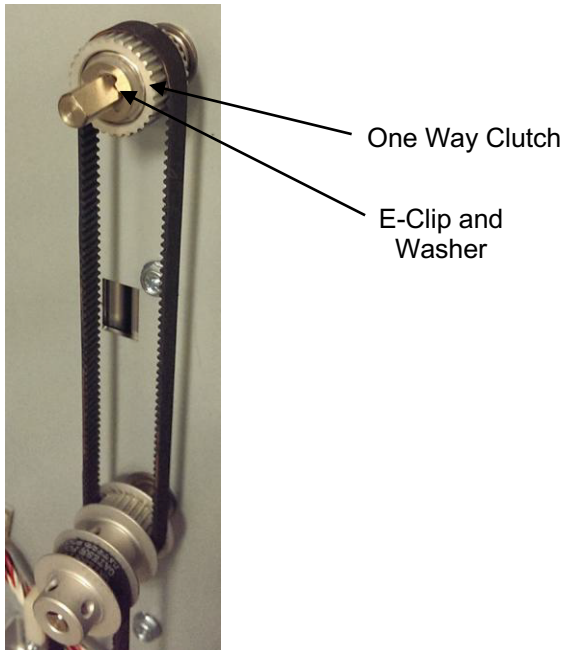

6. Place the new One Way Clutch Assembly on to the Shaft.
7. Install the Washer and the E-Clip.
8. Connect the Power Cord.
9. Power ON the entire printing system.

REP 2.19 Drive Idler Roller Assembly Replacement PARTS LIST ON PL 3.3

Use this procedure to remove and install a one way Drive Idler Roller Assembly.

Removal Procedure

WARNING

Do not perform repair activities with the power on or electrical power supplied to the machine. Some machine components contain dangerous electrical voltages that can result in electrical shock and possible serious injury. See Section 0, page vi for other languages.

1. Switch power OFF to entire printing system.
2. Disconnect the Power Cord.
3. Do REP 2.21.1 to remove the 534T Belt
4. Remove the E-ring and the Spacer.
5. Slide out the old Idler Roller from the Stud.

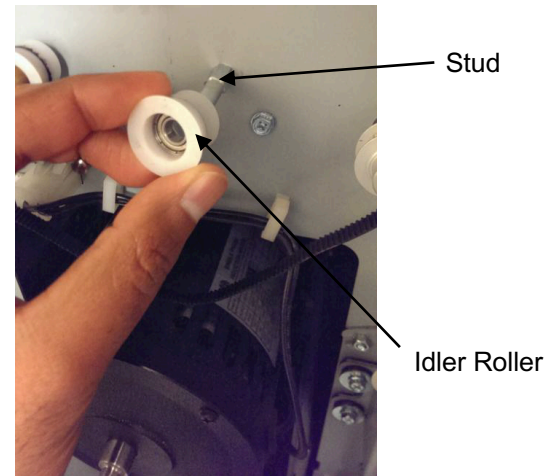

6. Place the new Idler Roller on the Stud.
7. Install the Spacer and the E-ring.
8. Do REP 2.21.1 to install the 534T Belt
9. Connect the Power Cord.
10. Power ON the entire printing system.

REP 2.20 Timing Pulley Replacement

PARTS LIST ON PL 3.9

Use this procedure to remove and install the Timing Pulley.

Removal Procedure

WARNING

Do not perform repair activities with the power on or electrical power supplied to the machine. Some machine components contain dangerous electrical voltages that can result in electrical shock and possible serious injury. See Section 0, page vi for other languages.

1. Switch power OFF to entire printing system.
2. Disconnect the Power Cord.
3. Do REP 1.6 to remove the Rear Cover.
4. Do REP 2.21 to remove the appropriate Timing Belt from the Pulley.
5. Remove the retaining ring from the roller shaft.



6. Remove the Timing Pulley by sliding it out.



Installation Procedure

1. Place the Timing Pulley in position on the Shaft and install the retaining ring.
2. Do REP 2.21 to install the appropriate Timing Belt.
3. Do REP 1.6 to install the Rear Cover.
4. Connect the Power Cord.
5. Power ON the entire printing system.

REP 2.21 Timing Belt Replacement

There are eight (8) belts used at the rear of the Frame in the AdvancePunch Pro.

Five (5) belts connect to motors.

Type of Belt	#	Motor	REP	Page
Belt, 534T, 2MM 2GT	1 belt	M8	REP 2.21.1	4-55
Belt, 134T, 2MM 2GT	3 belts	M1 M6 M7	REP 2.21.2	4-56
Belt, 179T, 2MM 2GT, 6MM Wide	1 belt	M2	REP 2.21.4	4-56

Three (3) belts are used to connect two nip rollers.

Type of Belt	#	Connects Rollers	RAP	Page
Belt, 150 T, 2MM 2GT	3 belts	N1 and N2 N2 and N3 N8 and N9	REP 2.21.3	4-56

Use the following procedures to replace the belts.

REP 2.21.1 534T Belt Replacement PARTS LIST ON PL 3.9

Use this procedure to remove and install the 534T Belt for the Bypass Motor (M8).

WARNING

Do not perform repair activities with the power on or electrical power supplied to the machine. Some machine components contain dangerous electrical voltages that can result in electrical shock and possible serious injury. See Section 0, page vi for other languages.

1. Switch power OFF to entire printing system.
2. Disconnect the Power Cord.
3. Do REP 1.6 to remove the Rear Cover.
4. Loosen the Tensioner and remove the old Belt.

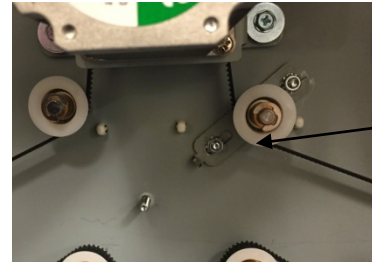

Tensioner

5. Place the new Belt in position around the Pulleys (11).

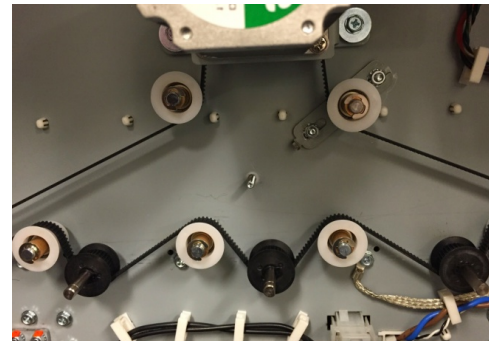

6. Adjust the Belt Tension, ADJ 1.4.2
7. Do REP 1.6 to install the Rear Cover.
8. Connect the Power Cord.
9. Power ON the entire printing system.

REP 2.21.2 134T Belt Replacement

PARTS LIST ON PL 3.9

Use this procedure to remove and install the 134T Belt for Motor M1, M6 and M7.

WARNING

Do not perform repair activities with the power on or electrical power supplied to the machine. Some machine components contain dangerous electrical voltages that can result in electrical shock and possible serious injury. See Section 0, page vi for other languages.

1. Switch power OFF to entire printing system.
2. Disconnect the Power Cord.
3. Do REP 1.6 to remove the Rear Cover.
4. Loosen the Tensioner and remove the old Belt.

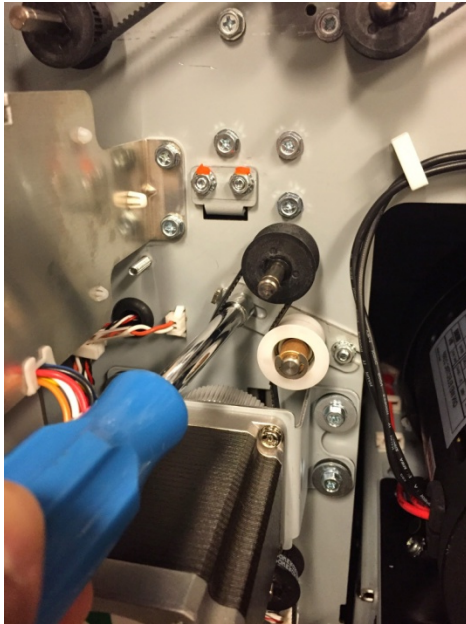

5. Place the new Belt in position around the Pulleys.
6. Adjust the Belt Tension, ADJ 1.4.3
7. Do REP 1.6 to install the Rear Cover.
8. Connect the Power Cord.
9. Power ON the entire printing system.

REP 2.21.3 150T Belt Replacement

PARTS LIST ON PL 3.9

Use this procedure to remove and install the 150T Belt connecting rollers N1 and N2, N2 and N3, N8 and N9.

Removal Procedure

WARNING

Do not perform repair activities with the power on or electrical power supplied to the machine. Some machine components contain dangerous electrical voltages that can result in electrical shock and possible serious injury. See Section 0, page vi for other languages.

1. Switch power OFF to entire printing system.
2. Disconnect the Power Cord.
3. Do REP 1.6 to remove the Rear Cover.
4. Do REP 2.20 to remove both of the Pulleys Connected to the Belt that is being replaced.

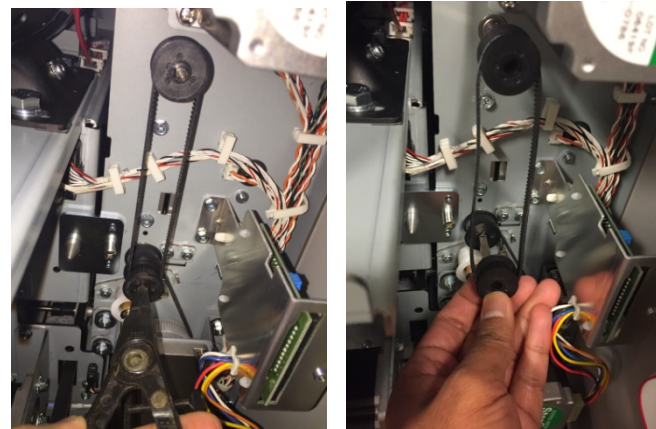

5. Place the Belt in position between the Pulleys and slide the Pulleys on to the Shafts.
6. Install the retaining rings
7. Do REP 1.6 to install the Rear Cover.
8. Connect the Power Cord.
9. Power ON the entire printing system.

REP 2.21.4 179T Belt Replacement

PARTS LIST ON PL 3.9

Use this procedure to remove and install the 179T belt for Acceleration motor M2.

WARNING

Do not perform repair activities with the power on or electrical power supplied to the machine. Some machine components contain dangerous electrical voltages that can result in electrical shock and possible serious injury. See Section 0, page vi for other languages.

1. Switch power OFF to entire printing system.
2. Disconnect the Power Cord.
3. Do REP 1.6 to remove the Rear Cover.
4. Loosen the Tensioner and remove the old Belt.

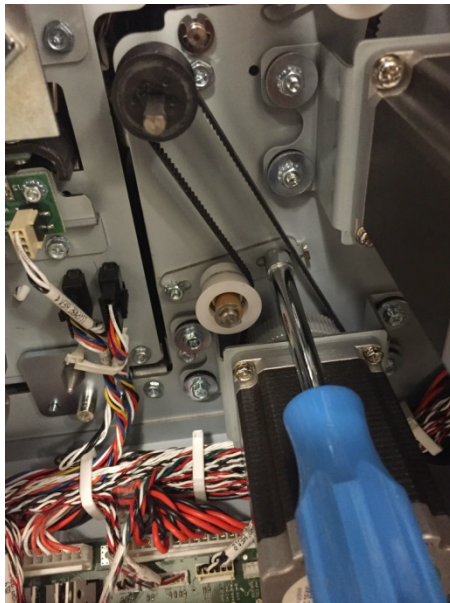

5. Place the new Belt in position around the Pulleys.
6. Adjust the Belt Tension, ADJ 1.4.4
7. Do REP 1.6 to install the Rear Cover.
8. Connect the Power Cord.
9. Power ON the entire printing system.

REP 2.22 Drive Roller Assembly Replacement

PARTS LIST ON PL 3.4

Use this procedure to remove and install a Drive Roller Assembly (Part # 7715093) used in Nips N1 - N14, except Nip N5.

Do not use this procedure for Nip N5, Do REP 2.22.1.

Procedures for individual Drive Rollers are located immediately after this general procedure.

Removal Procedure

1. Switch power OFF to entire printing system.
2. Do REP 1.6 to remove the Rear Cover.
3. Open the Front Door.
4. Locate the appropriate Drive Roller.

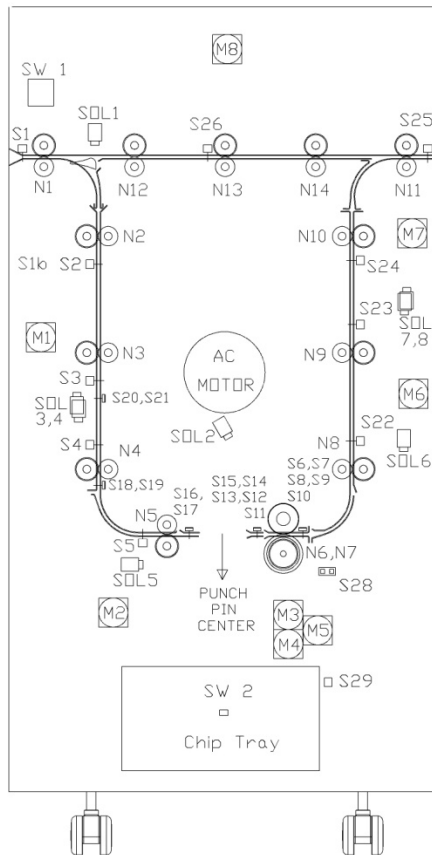

5. For all Drive Rollers (except N1 and N11), do REP 3.1 to remove the Punch Module.
6. Do REP 2.21 to remove the Belt from the appropriate Drive Roller Shaft.
7. Do REP 2.20 to remove the Pulley from the appropriate Drive Roller Shaft.
8. Remove the E-Ring and the Washer from the end of the Drive Roller Shaft at the front of the machine.

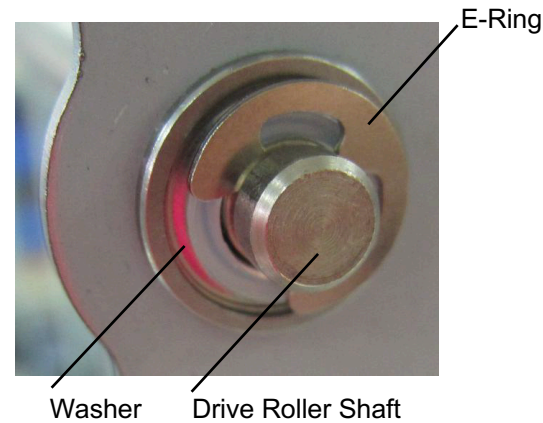

9. Remove the E-Ring and the Washer from the end of the Drive Roller Shaft at the rear of the machine.

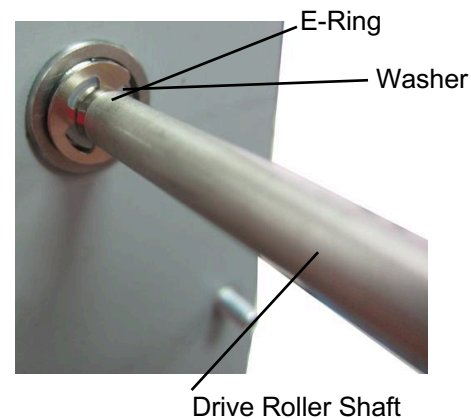

10. Remove the Drive Roller.

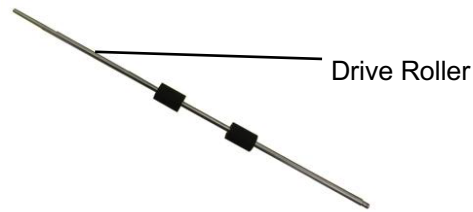

11. Remove the Bearing from the front of the machine.
12. Remove the Bearing from the rear of the machine.

Installation Procedure

1. Place the Drive Roller in position
2. Place the Bearing in position at the front of the machine.
3. Place the Bearing in position at the rear of the machine.
4. Place the Washer and the E-Ring in position the end of the Drive Roller Shaft at the front of the machine.
5. Place the Washer and the E-Ring in position the end of the Drive Roller Shaft at the rear of the machine.
6. Do REP 2.20 to install the Pulley on the appropriate Drive Roller Shaft.
7. Do REP 2.21 to install the Belt on the appropriate Drive Roller.
8. Adjust the Belt Tension, ADJ 1.4
9. For all Drive Rollers (except N1 and N11), do REP 3.1 to install the Punch Module.
10. Do REP 1.6 to install the Rear Cover.
11. Close the Front Door.
12. Connect the Power Cord.
13. Power ON the entire printing system.

REP 2.22.1 Drive Roller N5 Replacement

Do the following to remove and replace the Drive Roller for Nip N5. (PL 3.4)

Removal Procedure

1. Switch power OFF to entire printing system.
2. Disconnect the Power Cord.
3. Do REP 1.6 to remove the Rear Cover.
4. Do REP 3.1 to remove the Punch Module.
5. Loosen the nuts (2) on the Tensioner of the M2 motor belt.

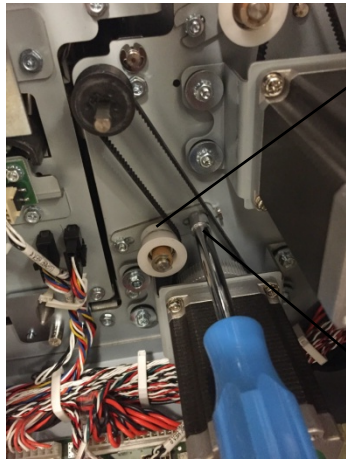

Tensioner

Nuts (2)

6. Remove the retaining ring from the shaft of roller N5.



7. Remove the Belt from the Motor Pulley

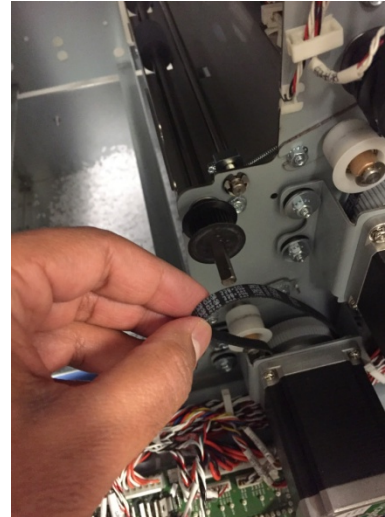

8. Slide the Pulley off the Roller Shaft.



9. Remove the E-Ring and the Washer from the rear side of the Shaft.

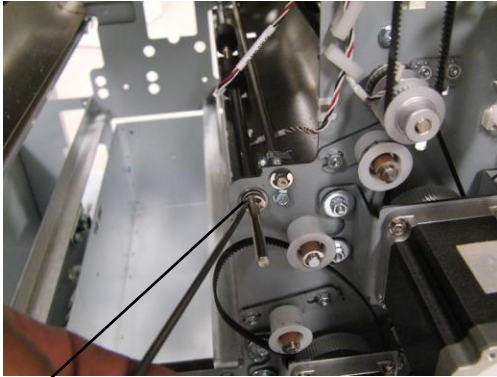

E-Ring and Washer

10. Remove the E-Ring at the front side of the Shaft.



E-Ring

11. Remove the Washer and Ball Bearing from the front side.

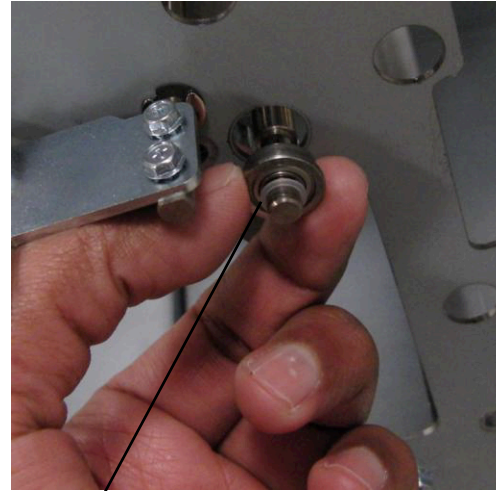

Washer and Ball Bearing

12. Remove the Ball Bearing from the rear side of the Shaft.

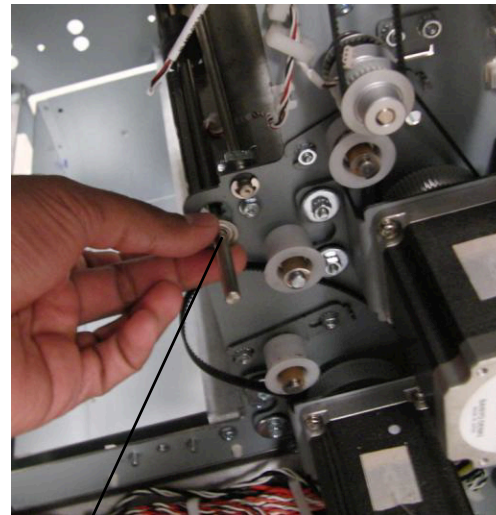

Ball Bearing

(Cont.)

13. Remove the Drive Roller.

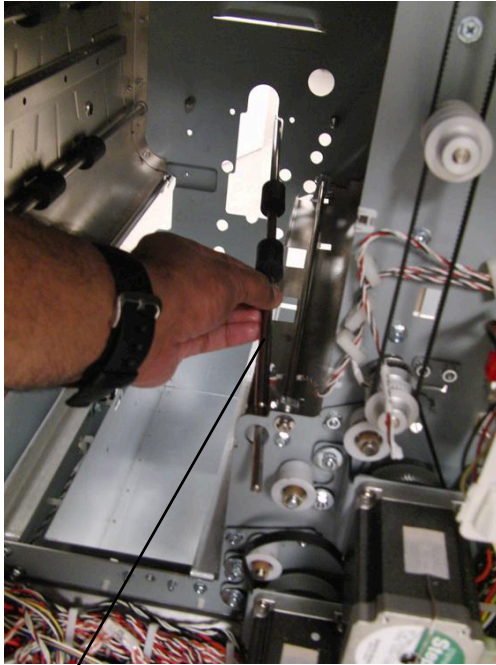

Drive Roller.

Installation Procedure

1. Place the Drive Roller in position.
2. Install the Ball Bearing at the rear side of the Shaft.
3. Install the Ball Bearing and the Washer at the front side of the Shaft.
4. Install the E-Ring at the front side of the Shaft
5. Install the Washer and the E-Ring at the rear side of the Shaft.
6. Slide the Pulley on to the Roller Shaft.
7. Place the Belt over the Pulley.
8. Install the retaining ring on the Drive Roller N5.
9. Move the Tensioner of the M2 motor belt into position and tighten the Screws (2).
10. Adjust the Belt Tension, ADJ 1.7.4
11. Do REP 3.1 to install the Punch Module.
12. Do REP 1.6 to install the Rear Cover.
13. Close the Front Door.
14. Connect the Power Cord.
15. Power ON the entire printing system.

REP 2.23 Stepper and Mount Assembly Replacement

PARTS LIST ON PL 3.6

Use this procedure to remove and install the Entrance Motor (M1), Accel Motor (M2), Exit Motor (M6), Decel Motor (M7), or Bypass Motor (M8).

WARNING

Do not perform repair activities with the power on or electrical power supplied to the machine. Some machine components contain dangerous electrical voltages that can result in electrical shock and possible serious injury. See Section 0, page vi for other languages.

1. Switch power OFF to entire printing system.
2. Disconnect the Power Cord.
3. Do REP 1.6 to remove the Rear Cover.

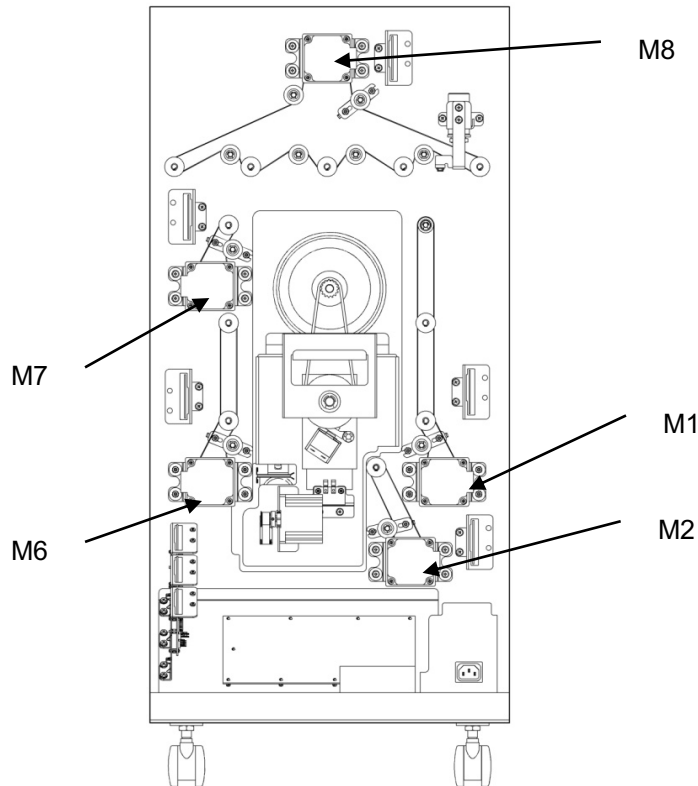

4. Locate the affected Motor (see PL 3.6).
5. Disconnect the Motor Connector from the corresponding Motor Driver (PL 3.6).

6. Remove the Screws (4) and the Stepper and Mount Assembly from the Rear Panel.

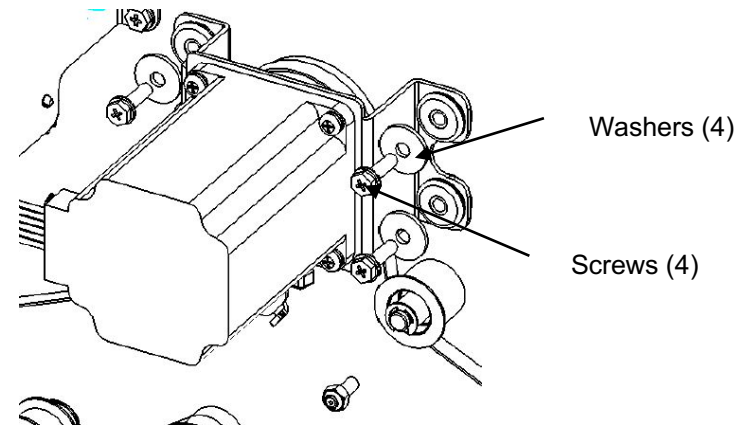

Installation Procedure

1. Place the Stepper and Mount Assembly in position and tighten the Screws (4).

Service replacement Stepper motors come in Configuration B. Remove (4) M4 Phillips Pan head screws and rotate the stepper motor. M1, M6 and M7- Config A; M2 and M8- Config B.

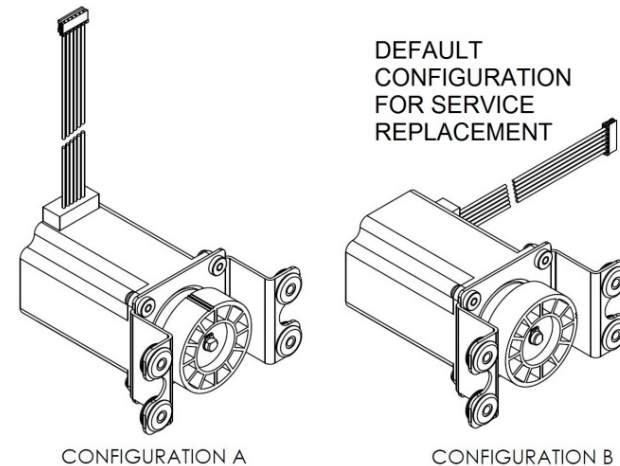

2. Connect the Motor Connector.
3. Do REP 1.6 to install the Rear Cover.
4. Connect the Power Cord.
5. Power ON the entire printing system.

REP 2.24 Bypass Open Sensor Replacement

PARTS LIST ON PL 3.7

Use this procedure to remove and install the Bypass Open Sensor (S27).

WARNING

Do not perform repair activities with the power on or electrical power supplied to the machine. Some machine components contain dangerous electrical voltages that can result in electrical shock and possible serious injury. See Section 0, page vi for other languages.

1. Switch power OFF to entire printing system.
2. Disconnect the Power Cord.
3. Do GP 6.4 to undock the Punch from the upstream and downstream equipment.
4. Do REP 1.11 Downstream side frame cover to remove the upper cover.
5. Do REP 1.6 to remove the Rear Cover.
6. Disconnect the Sensor Connector at the Sensor.



Screw

Bypass Open
Sensor

7. Remove the Screw and Nut that secure the Sensor to the sheet metal part.

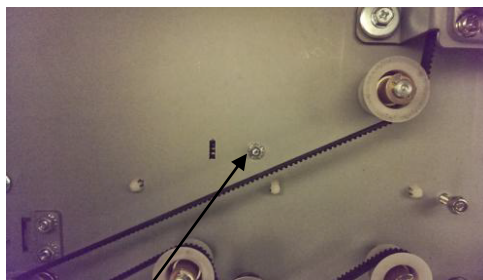

Nut

Installation Procedure

1. Place the Sensor in position, then install and tighten the Screw and the Nut.
2. Connect the Sensor Connector.
3. Do REP 1.6 to install the Rear Cover.
4. Do REP 1.11 Downstream side frame cover to install the upper cover.
5. Do GP 6.3 to dock the Punch to the upstream and downstream equipment.
6. Connect the Power Cord.
7. Power ON the entire printing system.

REP 2.25 Paper Path Sensor Replacement

PARTS LIST ON PL 3.7

Use the following procedures to remove and install the paper path sensors.

WARNING

Do not perform repair activities with the power on or electrical power supplied to the machine. Some machine components contain dangerous electrical voltages that can result in electrical shock and possible serious injury. See Section 0, page vi for other languages.

Sensor #	REP #	Sensor #	REP #
S1	REP 2.25.1	S16	REP 2.25.8
S2	REP 2.25.2	S17	REP 2.25.8
S3	REP 2.25.2	S18	REP 2.25.5
S4	REP 2.25.2	S19	REP 2.25.5
S5	REP 2.25.3	S20	REP 2.25.5
S6	REP 2.25.6	S21	REP 2.25.5
S7	REP 2.25.6	S22	REP 2.25.2
S8	REP 2.25.6	S23	REP 2.25.2
S9	REP 2.25.6	S24	REP 2.25.2
S10	REP 2.25.6	S25	REP 2.25.1
S11	REP 2.25.7	S26	REP 2.25.1
S12	REP 2.25.7	S27	REP 2.24
S13	REP 2.25.7	S28	REP 2.25.4
S14	REP 2.25.7	S1b	REP 2.25.2
S15	REP 2.25.7		

REP 2.25.1 Entrance Sensor (S1,) Exit Sensor (S25), and Bypass Middle Sensor (S26) Replacement

PARTS LIST ON PL 4.5

Use this procedure to remove and install the Sensor and Bracket Assembly for the Entrance Sensor, S1 and Exit Sensor, S25.

1. Switch power OFF to entire printing system.
2. Disconnect the Power Cord.
3. Open the Front Door.

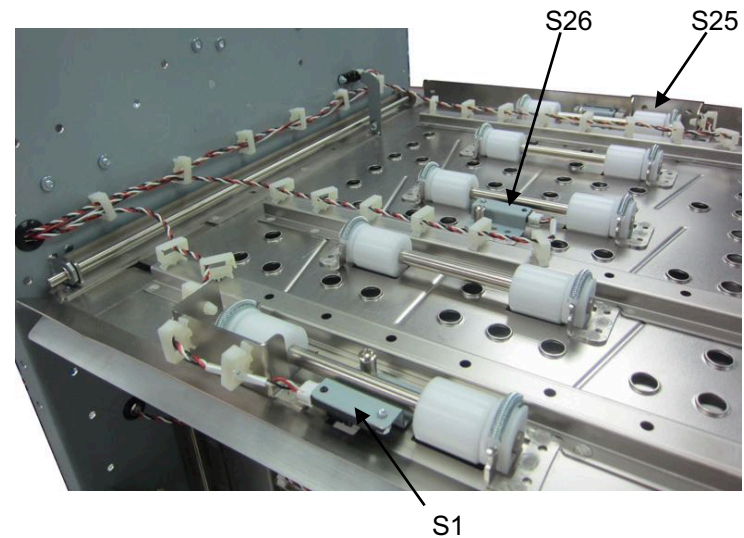

4. Disconnect the Sensor Connector at the Sensor.
5. Remove the Barrell Screw and Lockwasher that secure the Sensor to the sheet metal part.
6. Remove the old Sensor.
7. Place the new Sensor in position, then install Lockwasher and Barrell Screw.
8. Close the Front Door.
9. Connect the Power Cord.
10. Power ON the entire printing system.

REP 2.25.2 Top, Middle, & Bottom Entrance Sensor (S2, S3, S4) and Top, Middle, & Bottom Exit Sensor (S22, S23, S24) Replacement
PARTS LIST ON PL 4.2 and PL 4.4

Use this procedure to remove and install the Sensor and Bracket Assembly for the Top, Middle, & Bottom Entrance Sensor (S2, S3, S4) and Exit Sensor (S22, S23, S24).

1. Switch power OFF to entire printing system.
2. Disconnect the Power Cord.
3. Remove the side panels as needed to access the Sensor (see REP 1.8 or REP 1.11).
4. Disconnect the sensor wire and the Sensor.
5. Remove the Barrel Screw and Lock Washer that secure the Sensor to the sheet metal part.

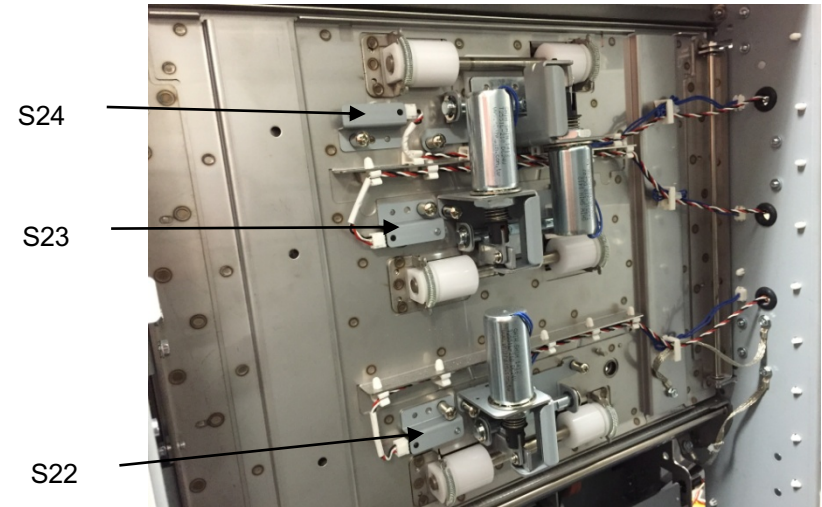
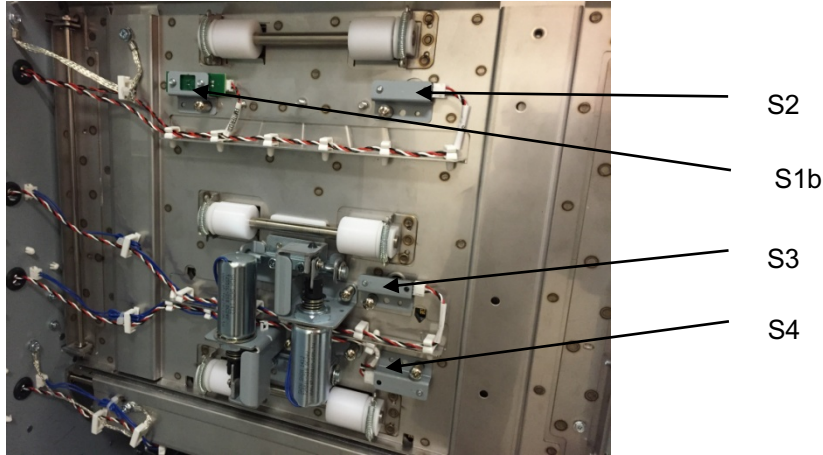

6. Remove the old Sensor.
7. Place the new Sensor in position, then install Lockwasher and Barrell Screw.
8. Connect the Power Cord.
9. Power ON the entire printing system.

REP 2.25.3 Accel Sensor (S5) Replacement

PARTS LIST ON PL 4.3

Use this procedure to remove and install the Sensor and Bracket Assembly for the Accel Sensor (S5).

1. Switch power OFF to entire printing system.
2. Disconnect the Power Cord.
3. Do REP 1.8 to remove the Upstream Side Frame Cover.
4. Open the Wire Saddles and release the Sensor Cable.
5. Disconnect the sensor connector at the Sensor.
6. Remove the Barrel Screw and Lock Washer that secure the Sensor to the sheet metal part.



Accel Sensor (S5)

7. Remove the old Sensor.
8. Place the new Sensor in position, then install Lockwasher and Barrell Screw.
9. Place Sensor Cable in the Wire Saddles.
10. Connect the Power Cord.
11. Power ON the entire printing system.

REP 2.25.4 Align Home Sensor (S28) Replacement

PARTS LIST ON PL 5.3

Use this procedure to remove and install the Sensor and Bracket Assembly for the Align Home Sensor (S28).

1. Switch power OFF to entire printing system.
2. Disconnect the Power Cord.
3. Do REP 1.11 to remove the Lower Downstream Side Frame Cover.
4. Disconnect the Sensor Wire Connector from the Sensor.

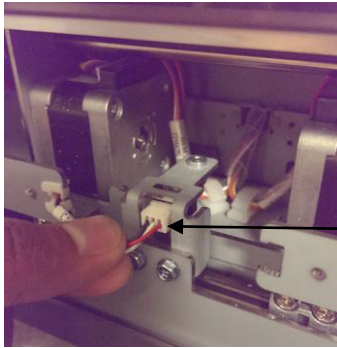

Sensor Wire Connector

5. Remove the M3 Screws (2) that secure the Sensor to the Bracket.

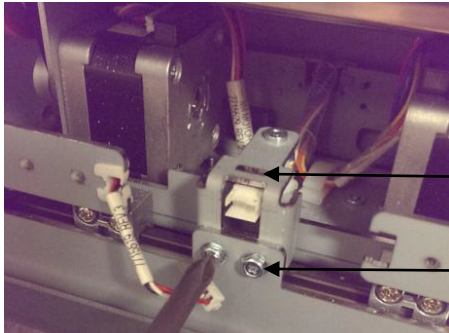

Sensor Bracket

Screws (2)

6. Remove the Sensor Sub-assembly.

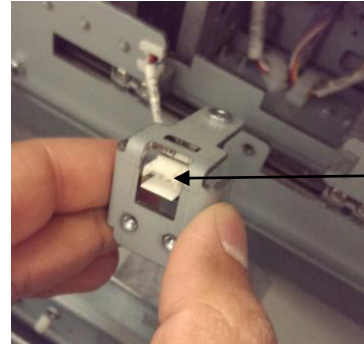

Sensor Sub-assembly

7. Place the new Sensor in position.
8. Tighten the M3 Screws (2) that secure the Sensor to the Bracket.
9. Connect the Sensor Connector to the Sensor.
10. Do REP 1.11 to install the Downstream Side Frame Cover.
11. Connect the Power Cord.
12. Power ON the entire printing system.

REP 2.25.5 Double Punch (Large) Backage Sensor Board Assembly (S18, S19) and Double Punch (X-Large) Backage Sensor Board Assembly (S20, S21) Replacement

PARTS LIST ON PL 4.1

Use this procedure to remove and install the Backage Sensor Board (S18, S19) or the Backage Sensor Board (S20, S21).

WARNING

Do not perform repair activities with the power on or electrical power supplied to the machine. Some machine components contain dangerous electrical voltages that can result in electrical shock and possible serious injury. See Section 0, page vi for other languages.

1. Switch power OFF to entire printing system.
2. Disconnect the Power Cord.
3. Do REP 1.6 to remove the Rear Cover.
4. Do REP 3.1 to remove the Punch Module.
5. Locate the Drive Entrance Panel
 - The upper board is the Backage Sensor Board (S20, S21).

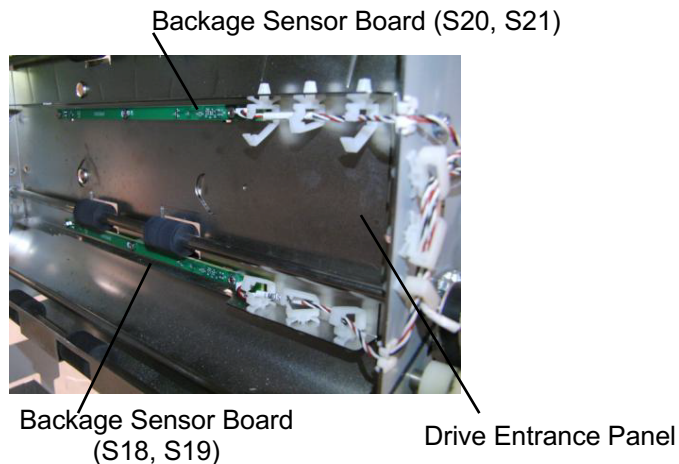

- The lower board is the Backage Sensor Board (S18, S19).

6. Disconnect the Sensor Board Connectors (2).

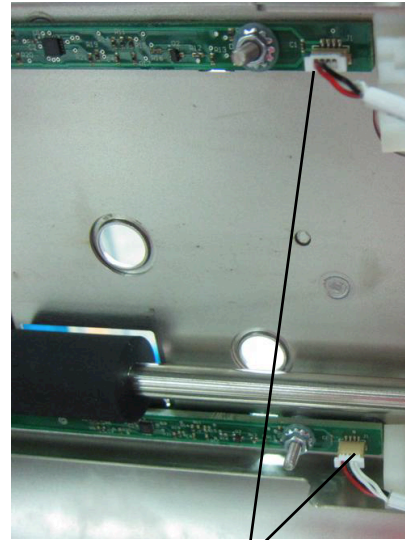

Sensor Board Connector (2)

7. Remove the Nuts (3) and Washers (3).
8. Remove the old Backage Sensor Board.
9. Place the new Punch Sensor Board in position.
10. Place the Washers (3) in position and tighten the Nuts (3).
11. Connect the Sensor Board Connector.
12. Do REP 3.1 to install the Punch Module.
13. Do REP 1.6 to install the Rear Cover.
14. Connect the Power Cord.
15. Power ON the entire printing system.

REP 2.25.6 Skew Sensor Board (S6 – S10) Replacement

PARTS LIST ON PL 5.4

Use this procedure to remove and install the Skew Sensor Board (S6, S7, S8, S9, S10).

1. Switch power OFF to entire printing system.
2. Disconnect the Power Cord.
3. Do REP 1.6 to remove the Rear Cover.
4. Do REP 3.1 to remove the Punch Module.

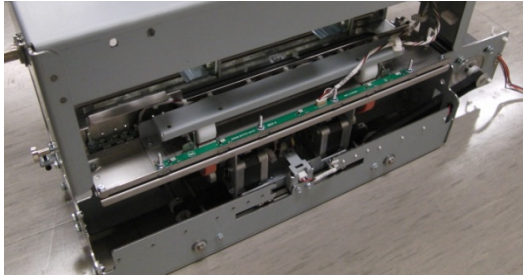

5. Disconnect the Skew Sensor Board Connector.

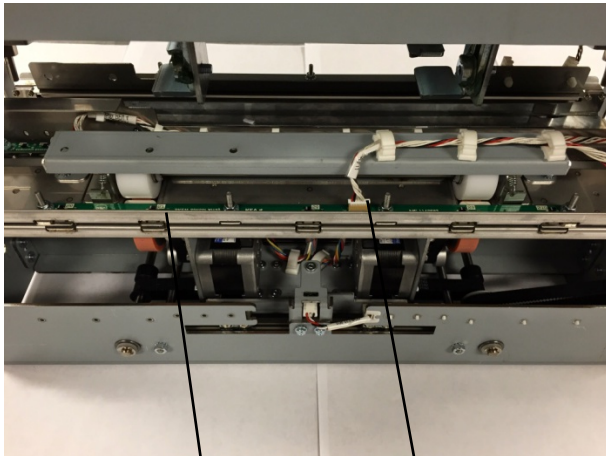

Skew Sensor Board Connector
Skew Sensor Board

6. Remove the Nuts (4), Washers (4), and the Skew Sensor Board. (do not remove the washers under the sensor board)

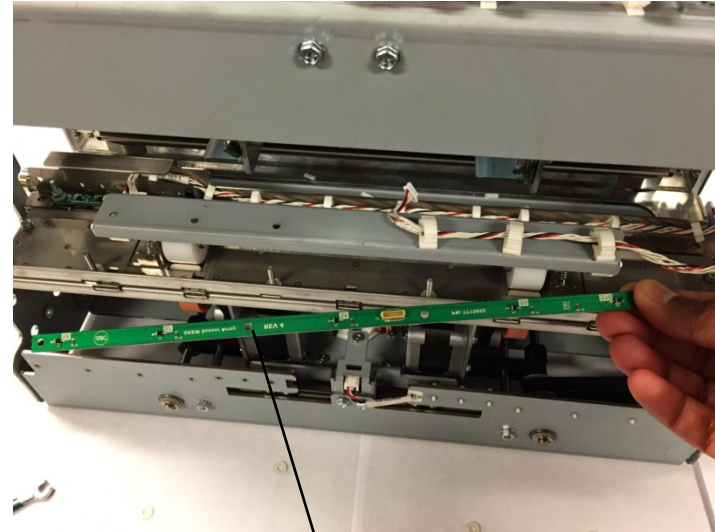

Skew Sensor Board

7. Place the new Skew Sensor Board in position.
8. Install the Washers (4) and tighten the Nuts (4). (Make sure there are (4) washers below the sensor board).
9. Connect the Sensor Board Connector.
10. Do REP 3.1 to install the Punch Module.
11. Do REP 1.6 to install the Rear Cover.
12. Connect the Power Cord.
13. Power ON the entire printing system.

**REP 2.25.7 Alignment Sensor Board (S11 – S15) Replacement
PARTS LIST ON PL 5.7**

Use this procedure to remove and install the Alignment Sensor Board (S11, S12, S13, S4, S15).

1. Switch power OFF to entire printing system.
2. Disconnect the Power Cord.
3. Do REP 1.6 to remove the Rear Cover.
4. Do REP 3.1 to remove the Punch Module.
5. Disconnect the Skew Sensor Board Connector.

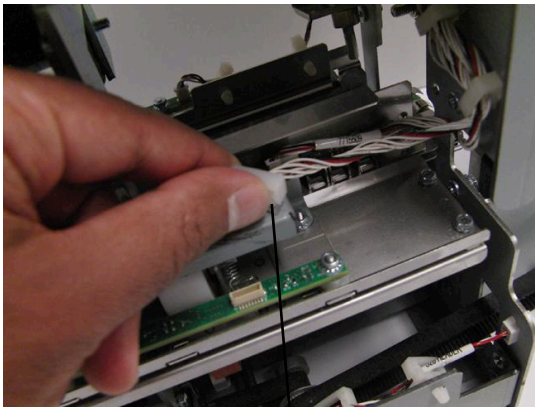

Skew Sensor Board Connector

6. Release the Cable Clamp and move the Cable out of the way.
7. Remove the M4 Nuts (2).

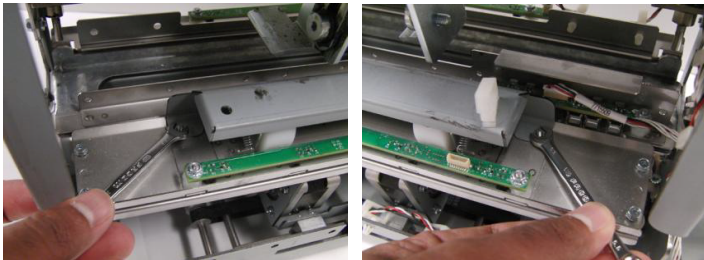

8. Remove the Roller Cover.

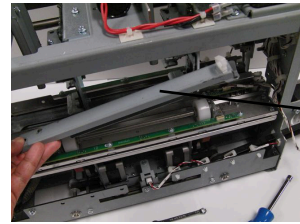

Roller Cover

9. Disconnect the Alignment Sensor Board Connector.

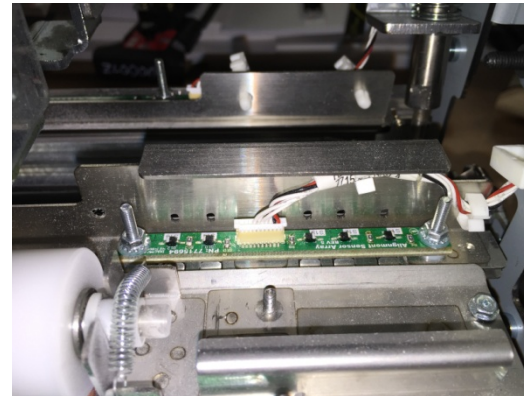

10. Release the Cable Clamp and move the Cable out of the way.
11. Remove the M4 Nuts (2) and Washers (2),

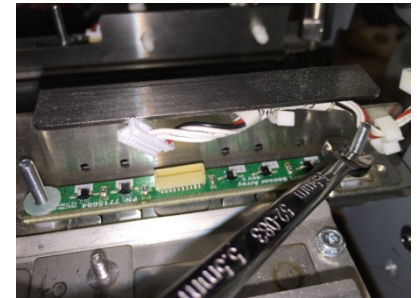
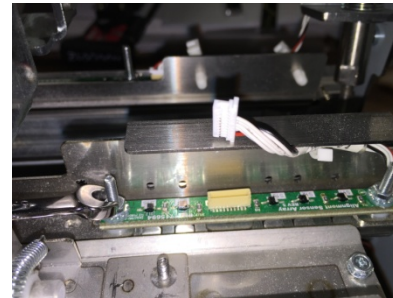

12. Remove the Alignment Sensor Board.

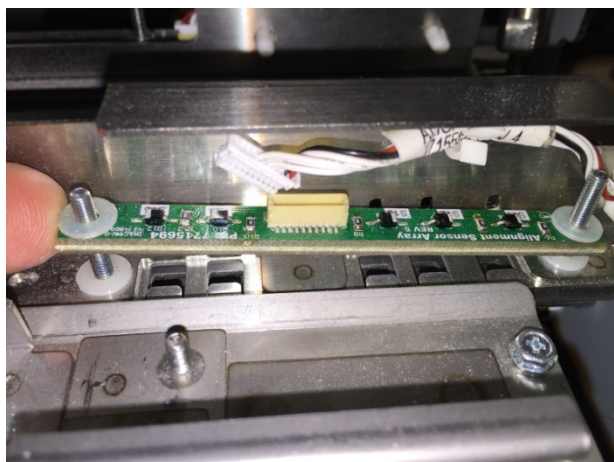

Installation Procedure

1. Place the new Alignment Sensor Board in position.
2. Install the Washers (2) and tighten the Nuts (2).
Note: There is (1) washer below and (1) washer above the sensor at each mounting location.
3. Place the Alignment Sensor Board Cable into the Cable Clamps and close the Cable Clamps.
4. Connect the Alignment Sensor Board Connector.
5. Place the Roller Cover in position.
6. Place the Skew Sensor Board Cable into the Cable Clamps and close the Cable Clamps.
7. Connect the Skew Sensor Board Connector.
8. Do REP 3.1 to install the Punch Module.
9. Do REP 1.6 to install the Rear Cover.
10. Connect the Power Cord.
11. Power ON the entire printing system.

REP 2.25.8 Backage Sensor Board (S16, S17) Replacement

PARTS LIST ON PL 5.7

Use this procedure to remove and install the Backage Sensor Board (S16, S17) or the Backage Sensor Bracket.

1. Switch power OFF to entire printing system.
2. Disconnect the Power Cord.
3. Do REP 1.6 to remove the Rear Cover.
4. Do REP 3.1 to remove the Punch Module.

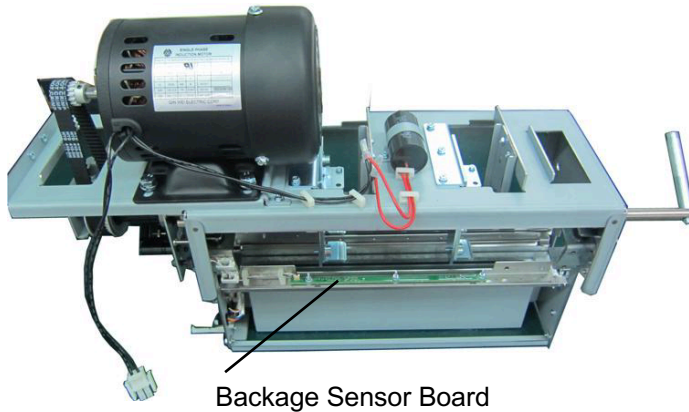

5. Disconnect the Sensor Board Connector at the Board.
6. Remove the Nuts (3), Washers (3), and the Backage Sensor Board.
7. To replace the Lower Backage Sensor Bracket or the Bracket Weldment,:
 - Open the Wire Saddles and remove the Sensor Cable.
 - Remove the M3 Nuts (2).
 - Remove the Bracket.
 - Remove the Bracket Weldment.
 - Place the new Bracket Weldment in position on the Studs (2)
 - Place the new Bracket in position in position on the Studs (2).
 - Tighten the M3 Nuts (2).
 - Place the Sensor Cable in the Wire Saddles, then close the wire Saddles.

8. Place the new Backage Sensor Board in position.
9. Install the Washers (3) and tighten the Nuts (3)
10. Connect the Sensor Board Connector.
11. Do REP 3.1 to install the Punch Module.
12. Do REP 1.6 to install the Rear Cover.
13. Connect the Power Cord.
14. Power ON the entire printing system.

REP 2.26 Motor Driver (Stepper Driver) Replacement

PARTS LIST ON PL 3.6

Use this procedure to remove and install a Motor Driver (Stepper Board) - DRV M1, DRV M2, DRV M3, DRV M4, DRV M5, DRV M6, DRV M7, or DRV M8.

WARNING

Do not perform repair activities with the power on or electrical power supplied to the machine. Some machine components contain dangerous electrical voltages that can result in electrical shock and possible serious injury. See Section 0, page vi for other languages.

1. Switch power OFF to entire printing system.
2. Disconnect the Power Cord.
3. Do REP 1.6 to remove the Rear Cover.
4. Locate the appropriate Motor Driver (see PL 3.6).
5. Disconnect the Connectors (3)

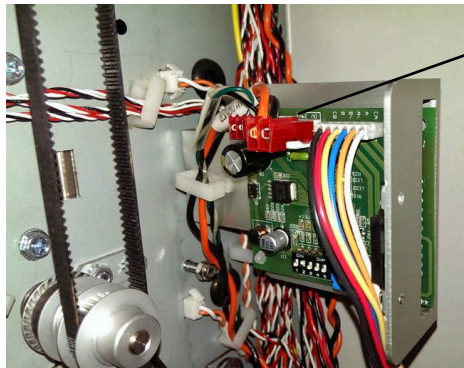

Connectors (3)

6. Remove the M4 Screws (2) and the Driver and Bracket Assembly.

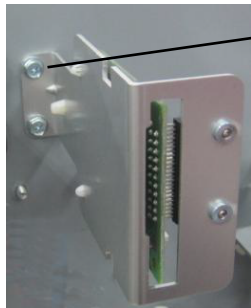

Screws (2)

7. Disconnect the Cables from the Motor Driver Board.

8. Set the Dip switches (6) on the new Motor Driver in accordance with the table below.

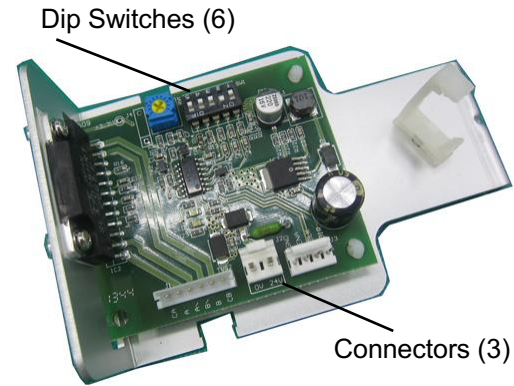

M1 Motor Driver		M2 Motor Driver		M3 Motor Drive	
1	Off	1	Off	1	Off
2	On	2	On	2	Off
3	Off	3	Off	3	On
4	Off	4	Off	4	On
5	Off	5	Off	5	On
M4 Motor Driver				M5 Motor Drive	
1	Off			1	Off
2	Off			2	Off
3	On			3	On
4	Off			4	Off
5	On			5	Off
M6 Motor Driver		M7 Motor Driver		M8 Motor Driver	
1	Off	1	Off	1	Off
2	On	2	On	2	On
3	Off	3	Off	3	Off
4	Off	4	Off	4	On
5	Off	5	Off	5	Off

Installation Procedure

1. Place the Driver and Bracket Assembly in position and tighten the M4 Screws (2).
2. Connect the Connectors (3).
3. Do REP 1.6 to install the Rear Cover.
4. Connect the Power Cord.
5. Power ON the entire printing system.

REP 2.27 Bypass Diverter Replacement

PARTS LIST ON PL 3.5

Use this procedure to remove and install the Bypass Diverter Assembly.

Removal Procedure

1. Switch power OFF to entire printing system.
2. Disconnect the Power Cord.
3. Do REP 1.6 to remove the Rear Cover.
4. Remove the E-clip from the Diverter Shaft on the front side.



5. Remove the M4 screws (2) from the Diverter Shaft on the rear side.

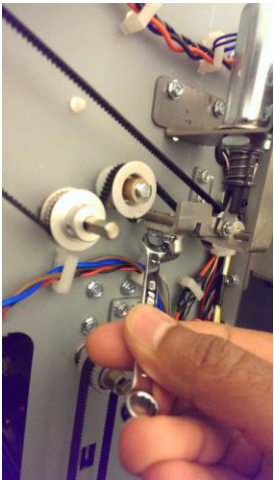

6. Remove the E-clip from the Diverter Shaft on the rear side.

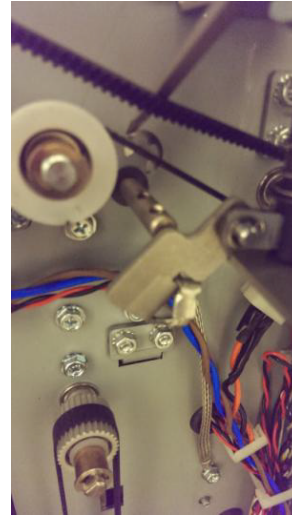

7. Slide the Diverter Assembly to the back side and remove the part.



(Cont.)

Installation Procedure

1. Slide the Diverter Assembly into position through to the rear side.
2. Install the E-clip on the Diverter Shaft at the rear side.
3. Install the M4 screws (2) on the Diverter Shaft at the rear side.
4. Install the E-clip on the Diverter Shaft at the front side.
5. Do REP 1.6 to install the Rear Cover.
6. Connect the Power Cord.
7. Power ON the entire printing system.
8. Do ADJ 1.2 Diverter Solenoid Adjustment.

REP 2.28 Solenoid Replacement

PARTS LIST ON PL 3.8

Use this procedure to remove and install the Solenoids in these assemblies:

Solenoid	Solenoid #	REP #
Diverter Subassembly	SOL 1	REP 2.28.1
Punch Clutch	SOL 2	REP 3.4
Entrance Idler Solenoid, Middle	SOL 3	REP 2.28.2
Entrance Idler Solenoid, Bottom	SOL 4	REP 2.28.2
Acceleration Roller Idler Solenoid	SOL 5	REP 2.28.3
Exit Idler Solenoid, Bottom	SOL 6	REP 2.28.4
Exit Idler Solenoid, Middle	SOL 7	REP 2.28.4
Exit Idler Solenoid, Top	SOL 8	REP 2.28.4

WARNING

Do not perform repair activities with the power on or electrical power supplied to the machine. Some machine components contain dangerous electrical voltages that can result in electrical shock and possible serious injury. See Section 0, page vi for other languages.

REP 2.28.1 Diverter Solenoid Replacement

PARTS LIST ON PL 3.3

Use this procedure to remove and install the Diverter Solenoid Assembly (SOL 1).

WARNING

Do not perform repair activities with the power on or electrical power supplied to the machine. Some machine components contain dangerous electrical voltages that can result in electrical shock and possible serious injury. See Section 0, page vi for other languages.

Removal Procedure

1. Switch power OFF to entire printing system.
2. Disconnect the Power Cord.
3. Do REP 1.6 to remove the Rear Cover.
4. If necessary, Do REP 1.18 to remove the Exhaust Fan Bracket along with the fan. Do not remove the fan from the bracket.
5. Remove the M4 (2) screws from the Diverter Shaft.

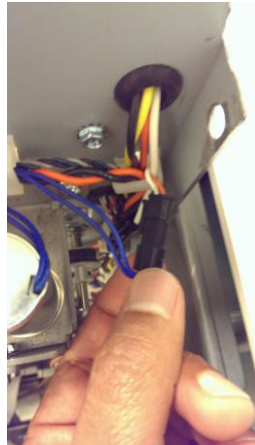
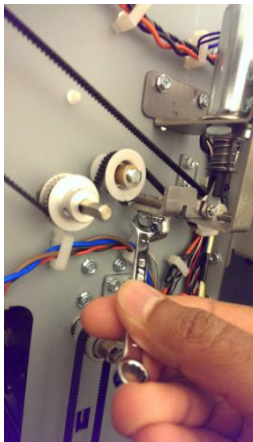

6. Disconnect the inline Connector for the Diverter Solenoid sub-assembly.

7. Remove Screws (2) from the diverter solenoid sub assembly.



8. Remove the Diverter Solenoid Sub-assembly.

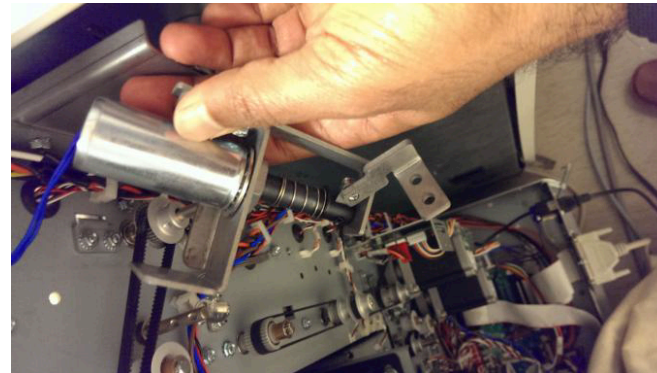

Installation Procedure

1. Place the new Solenoid in position and tighten the Screws (2).
2. Connect the inline Connector for the Diverter Solenoid.
3. Place the Cable into the Cable Clamps and close the Cable Clamps
4. If necessary, Do REP 1.18 to install the Exhaust Fan Bracket
5. Do ADJ 1.2 Diverter Solenoid Adjustment.
6. Do REP 1.6 to install the Rear Cover.
7. Connect the Power Cord.
8. Power ON the entire printing system.

REP 2.28.2 Entrance Idler Solenoid Replacement

PARTS LIST ON PL 4.2

Use this procedure to remove and install the Entrance Idler Solenoids (SOL 3 & SOL 4).

1. Switch power OFF to entire printing system.
2. Disconnect the Power Cord.
3. Do GP 6.4 Undock the Punch.
4. Do REP 1.8 to remove the Upstream Side Frame Cover.
5. Open the Front Door.
6. Disconnect the Solenoid Connector for the Solenoid being replaced.

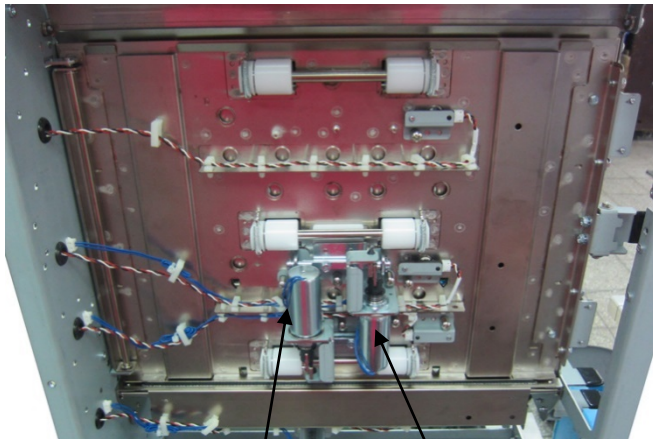

SOL4 SOL3

7. Open the Cable Clamps and remove the Cable.
8. Remove the M4 Barrel Screws (3) and the Solenoid.
9. Place the new Solenoid in position and tighten the Screws (3).
10. Connect the Solenoid Connector.
11. Place the the Cable into the Cable Clamps and close the Cable Clamps
12. Close the Front Door.
13. Do GP 6.3 Dock the Punch.
14. Connect the Power Cord.
15. Power ON the entire printing system.

REP 2.28.3 Acceleration Roller Idler Solenoid Replacement

PARTS LIST ON PL 4.3

Use this procedure to remove and install the Acceleration Roller Idler Solenoid (SOL 5).

1. Switch power OFF to entire printing system.
2. Disconnect the Power Cord.
3. Do GP 6.4 Undock the Punch.
4. Do REP 1.8 to remove the Upstream Side Frame Cover.
5. Open the Front Door.
6. Disconnect the Solenoid Connector.

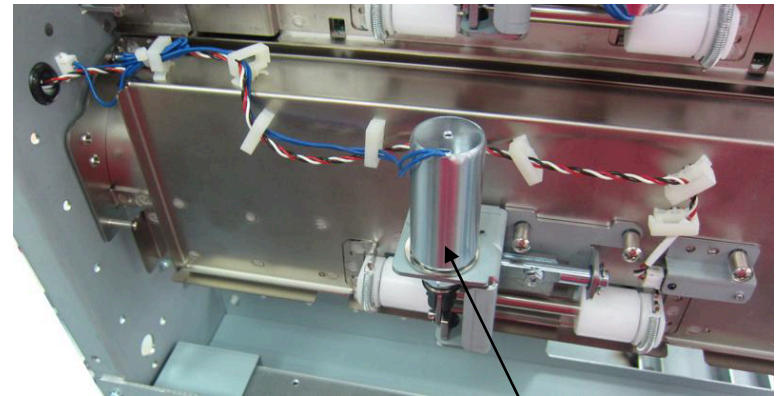

SOL5

7. Open the Cable Clamps and remove the Cable.
8. Remove the M4 Barrel Screws (3) and the Solenoid.
9. Place the new Solenoid in position and tighten the Screws (3).
10. Connect the Solenoid Connector.
11. Place the the Cable into the Cable Clamps and close the Cable Clamps
12. Close the Front Door.
13. Do GP 6.3 Dock the Punch.
14. Connect the Power Cord.
15. Power ON the entire printing system.

REP 2.28.4 Exit Idler Solenoid Replacement

PARTS LIST ON PL 4.4

Use this procedure to remove and install the Exit Idler Solenoids (SOL 6, SOL 7, & SOL 8)

1. Switch power OFF to entire printing system.
2. Disconnect the Power Cord.
3. Do GP 6.4 Undock the Punch.
4. Do REP 1.11 to remove the Lower Downstream Side Frame Cover.
5. Open the Front Door.
6. Disconnect the Solenoid Connector.

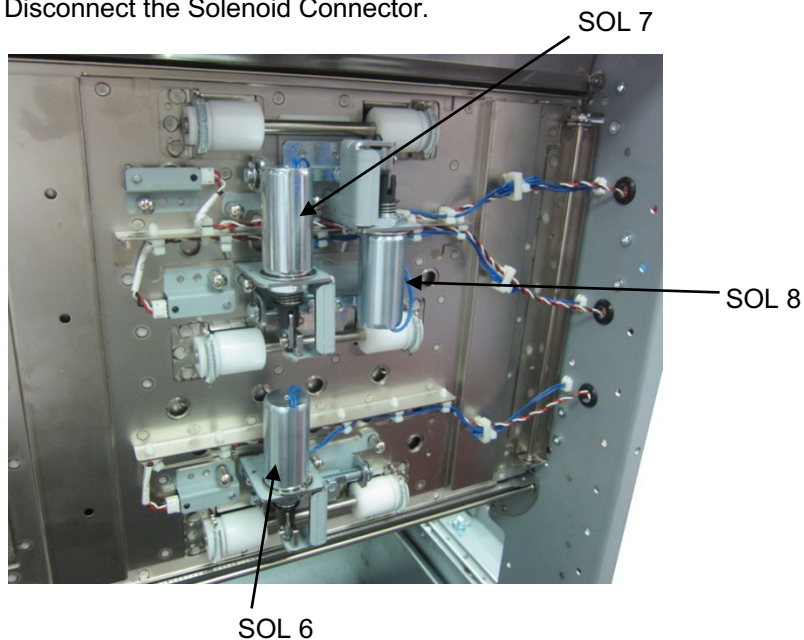

7. Open the Cable Clamps and remove the Cable.
8. Remove the M4 Barrel Screws (3) and the Solenoid.
9. Place the new Solenoid in position and tighten the Screws (3).
10. Connect the Solenoid Connector.
11. Place the the Cable into the Cable Clamps and close the Cable Clamps
12. Close the Front Door.
13. Do GP 6.3 Dock the Punch.
14. Connect the Power Cord.

15. Power ON the entire printing system.

REP 2.29 Upper Bypass Panel Anti-Static Brush Replacement PARTS LIST ON PL 4.5

Use this procedure to replace the Anti-Static Brush on the Upper Bypass Panel.

WARNING

Do not perform repair activities with the power on or electrical power supplied to the machine. Some machine components contain dangerous electrical voltages that can result in electrical shock and possible serious injury. See Section 0, page vi for other languages.

1. Switch power OFF to entire printing system.
2. Disconnect the Power Cord.
3. Do GP 6.4 to undock the Punch from the downstream equipment.

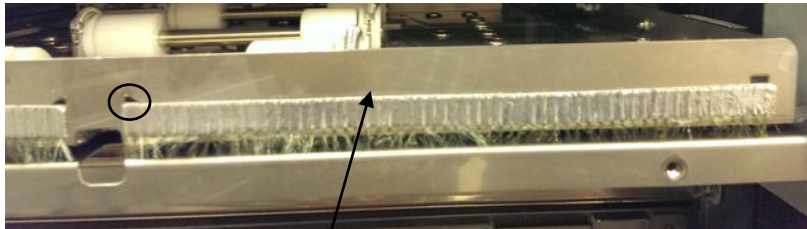

Anti-Static Brush



4. Peel off the old Anti-Static Brush.
5. Clean the surface with some rubbing alcohol
6. Affix the new brush inside referencing the cut-outs as shown above.
7. Do GP 6.4 to dock the Punch from the downstream equipment.
8. Connect the Power Cord.
9. Power ON the entire printing system.

REP 2.30 Chip Tray Home Switch Replacement PARTS LIST ON PL 3.5

Use this procedure to remove and install the Chip Tray Home Switch (SW2).

1. Open the Front Door.

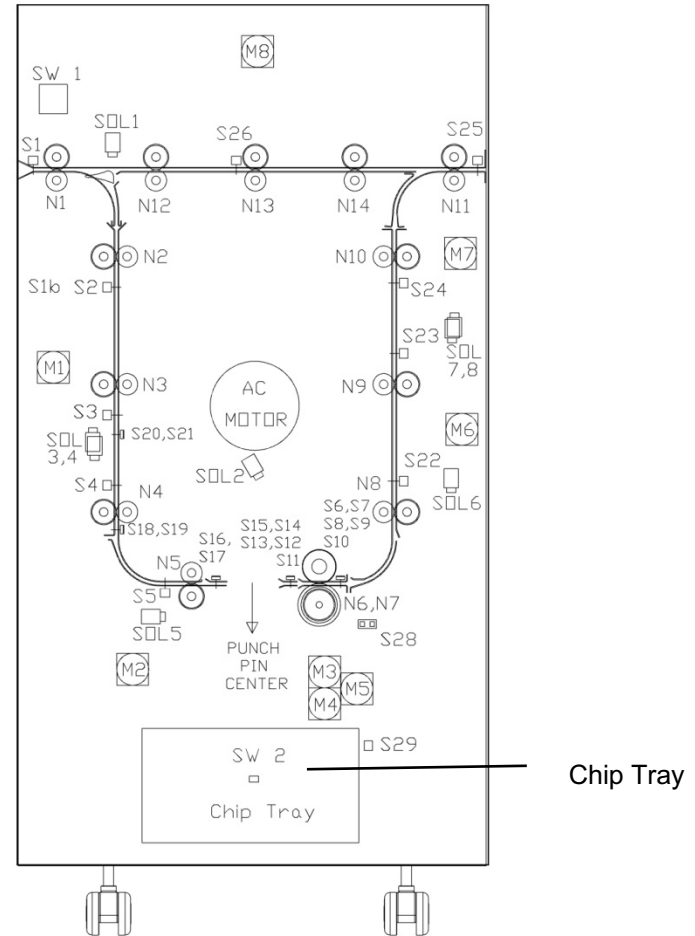

2. Remove the Chip Tray.

3. Disconnect Cable 7715485 at the Chip Tray Home Switch.

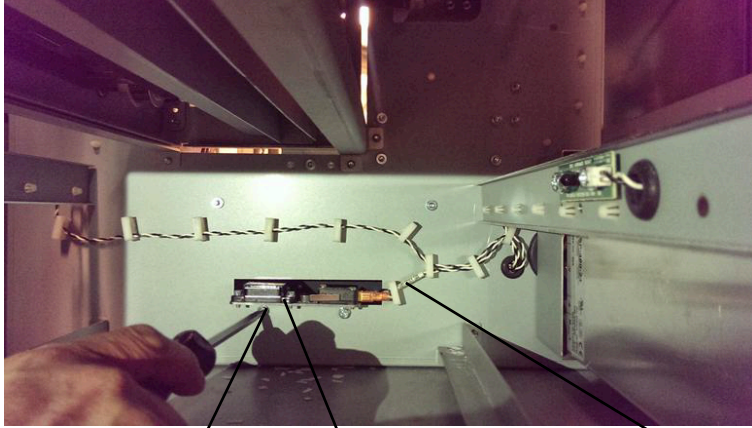

Screws (2) Chip Tray Home Switch Cable

4. Remove the Screws (2) and the old Chip Tray Home Switch Bracket.
5. Place the new Chip Tray Home Switch Bracket in position and tighten the Screws (2).
6. Connect Cable 023N01327 at the Chip Tray Home Switch.
7. Put the Chip Tray in position and push the Chip Tray Assembly in firmly until it latches.
8. Close the Front Door.
9. Connect the Power Cord.
10. Power ON the entire printing system.

REP 2.31 Chip Level Emitter Replacement

PARTS LIST ON PL 3.5

Use this procedure to remove and install the Chip Level Emitter Assembly.

WARNING

Do not perform repair activities with the power on or electrical power supplied to the machine. Some machine components contain dangerous electrical voltages that can result in electrical shock and possible serious injury. See Section 0, page vi for other languages.

1. Switch power OFF to entire printing system.
2. Disconnect the Power Cord.
3. Open the Front Door.
4. Remove the Chip Tray.
5. Locate the Chip Level Emitter on the Frame at the left (upstream) side of the Chip Tray compartment.
6. Disconnect Cable 023N01327 at the Chip Level Emitter.



7. Remove the Screws (2) and the old Chip Level Emitter. There will be Washers (4) between the Sensor and the sheet metal Bracket.
8. Place the new Chip Level Emitter, and the Washers (4), in position and tighten the Screws (2).
9. Connect Cable 7715485 at the Chip Level Emitter.
10. Put the Chip Tray in position and push the Chip Tray Assembly in firmly until it latches.
11. Close the Front Door.
12. Connect the Power Cord.
13. Power ON the entire printing system.

REP 2.32 Chip Level Receiver Replacement

PARTS LIST ON PL 3.5

Use this procedure to remove and install the Chip Level Receiver Assembly.

WARNING

Do not perform repair activities with the power on or electrical power supplied to the machine. Some machine components contain dangerous electrical voltages that can result in electrical shock and possible serious injury. See Section 0, page vi for other languages.

1. Switch power OFF to entire printing system.
2. Disconnect the Power Cord.
3. Open the Front Door.
4. Remove the Chip Tray.
5. Locate the Chip Level Receiver on the Frame at the right (downstream) side of the Chip Tray compartment.
6. Disconnect Cable 023N01327 at the Chip Level Receiver.

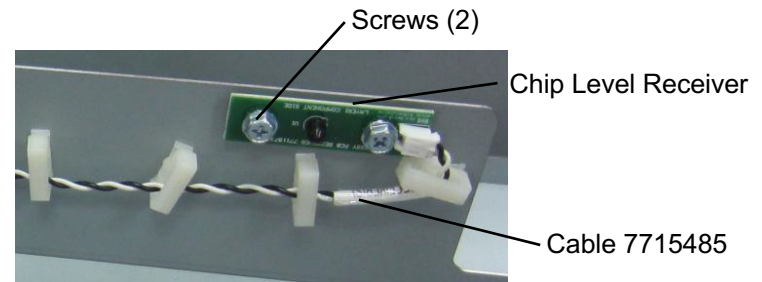

7. Remove the Screws (2) and the old Chip Level Receiver. There will be Washers (4) between the Sensor and the sheet metal Bracket.
8. Place the new Chip Level Receiver, and the Washers (4), in position and tighten the Screws (2).
9. Connect Cable 7715485 at the Chip Level Receiver.
10. Install the Clear Cover.
11. Put the Chip Tray in position and push the Chip Tray Assembly in firmly until it latches.
12. Close the Front Door.
13. Connect the Power Cord.
Power ON the entire printing system.

3. Punch Module

REP 3.1 Punch Module Replacement

PARTS LIST ON PL 5.1

Use this procedure to remove and install the Punch Module.

REP 3.1.1 Punch Module Removal

WARNING

Do not perform repair activities with the power on or electrical power supplied to the machine. Some machine components contain dangerous electrical voltages that can result in electrical shock and possible serious injury. See Section 0, page vi for other languages.

1. Switch power OFF to entire printing system.
2. Disconnect the Power Cord.
3. Do REP 1.6 to remove the Rear Cover.
4. Open the Front Door.
5. Use the handle to unlock the Die Set. Remove the Die set and insert it into one of the Die storage racks.



6. Use the levers (blue) to open the Acceleration Roller Idler Panel and the Accel Idler Panel compartments.

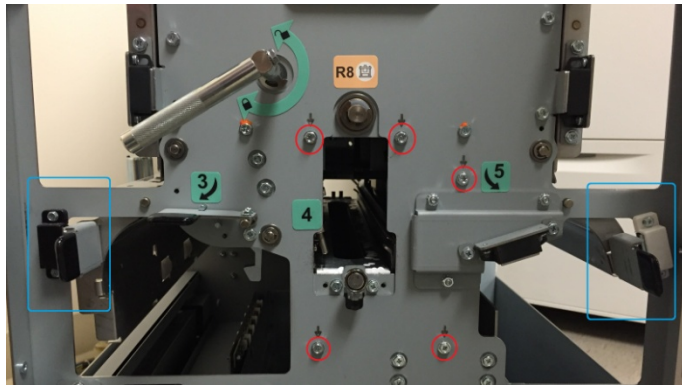

7. Remove the M4 X 10 Phillips Head Screw and the Die Lock Handle.



8. Remove the M4 Screws (5) from the Front Frame. The screws to be removed are marked with a downward arrow (↓).



9. Go to the rear of the Punch.
10. Disconnect the Connectors (2) for Sensors S6-S10 and S11-S15.



11. Disconnect the Connector for Sensor S28.



12. Disconnect the Connector for Solenoid SOL2.



13. Disconnect the Connector for the M5 Motor Driver.



14. Disconnect the Connectors (2) for the M3 Header and the M4 Header.

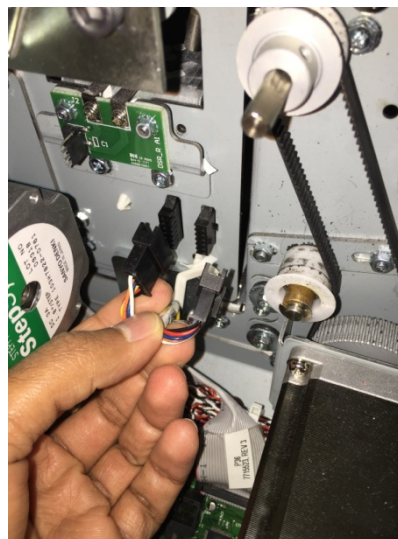

15. Disconnect the Die Set Recognition Connector.



16. Disconnect the Connector for Sensors S16 and S17.



17. Disconnect the Connector for Punch Motor M10.

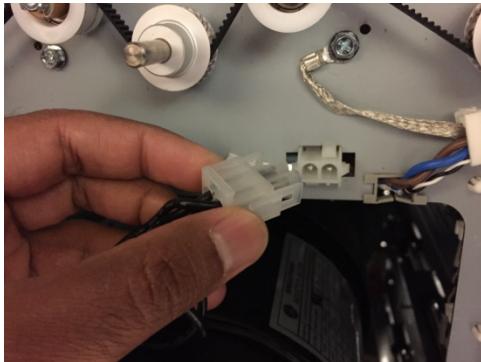

(Cont.)

18. Do the following to remove the Punch Module Mount Bracket (Lock Plates).

- Use a Phillips Head Screwdriver to loosen the Captive Screw from the left Punch Module Mount Bracket.
- Remove the left Punch Module Mount Bracket.

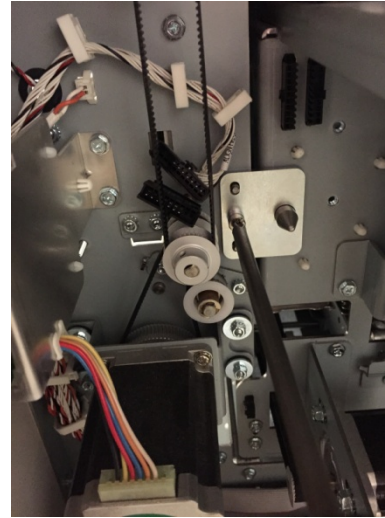

- Use a Phillips Head Screwdriver to loosen the Captive Screw from the right Punch Module Mount Bracket.
- Remove the right Punch Module Mount Bracket.

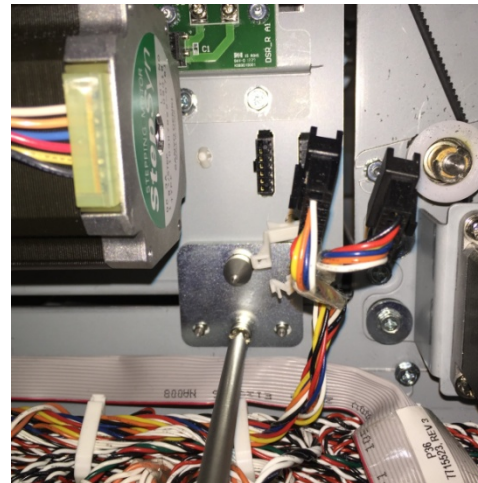

19. Do the following to remove the Punch Module

- Grasp the handle near with one hand and pull to slide out the Punch Module.
- Support the Punch Module with your other hand as you slide it out.
- Make sure the punch module does not drop on the Control board as you remove it.

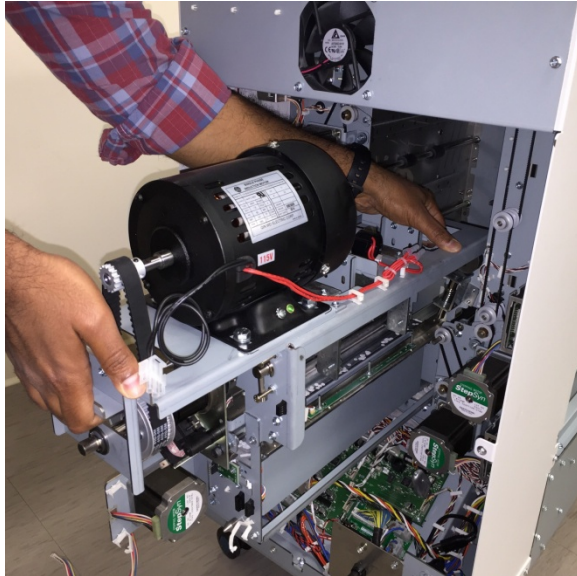

- Place the Punch Module on a flat surface.

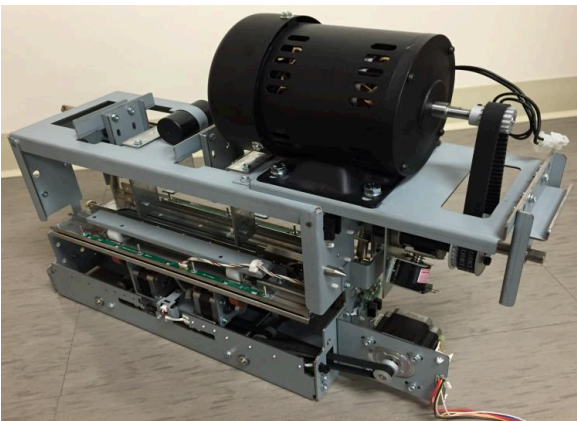

REP 3.1.2 Punch Module Installation

Use this procedure to install the Punch Module.

1. Do the following to slide the Punch Module into the slot at the rear of the machine.
 - Grasp the Clutch Pulley Sub Assembly with your right hand and support the Punch Module with your left hand
 - Slide the Punch Module into the slot.
2. Do the following to install the Lock Plates (green).
 - Place the Lock Plates (2) in position).
 - Use a Phillips Head Screwdriver to tighten the Screws (2) through the Lock Plates (2).
3. Connect all electrical Connectors (11).
 - Connector for Punch Motor M10.
 - Connector for Sensors S16 and S17.
 - Die Set Recognition Connector
 - Connectors (2) for the M3 Header and the M4 Header.
 - Connector for the M5 Motor Driver
 - Connector Solenoid SOL2.
 - Connector for Sensor S28.
 - Connectors (2) for Sensors S6-S10 and S11-S15.
4. Go to the front of the Punch
5. Tighten the M4 Screws (5) into the Front Frame.
6. Install the Die Lock Handle and tighten the M4 X 10 Phillips Head Screw.
7. Install the Die Set (see *Operation Instructions Manual*).
8. Use the handle to lock the Die Set.
(Cont.)
9. Close the Front Door.
10. Do REP 1.6 to install the Rear Cover.
11. Connect the Power Cord.
12. Power ON the entire printing system.

REP 3.2 Punch Motor Replacement

PARTS LIST ON PL 5.8

Use this procedure to remove and install the Punch Motor (M10).

Removal Procedure

WARNING

Do not perform repair activities with the power on or electrical power supplied to the machine. Some machine components contain dangerous electrical voltages that can result in electrical shock and possible serious injury. See Section 0, page vi for other languages.

1. Switch power OFF to entire printing system.
2. Disconnect the Power Cord.
3. Do REP 1.6 to remove the Rear Cover.
4. Do REP 3.1 to remove the Punch Module.

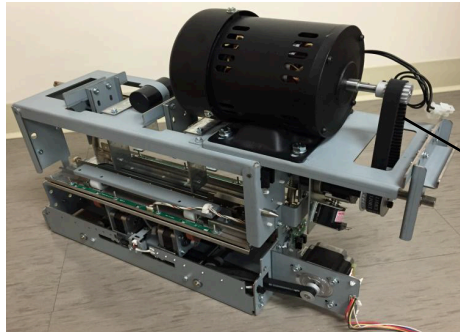

Punch Motor Belt

5. Do REP 3.3 Punch Motor Belt Replacement (Timing Belt) to remove the Punch Motor Belt.

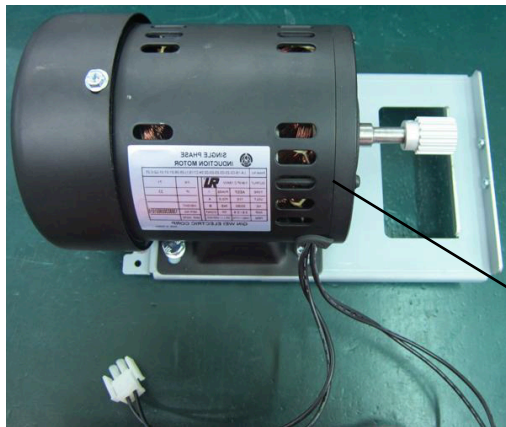

Punch Motor

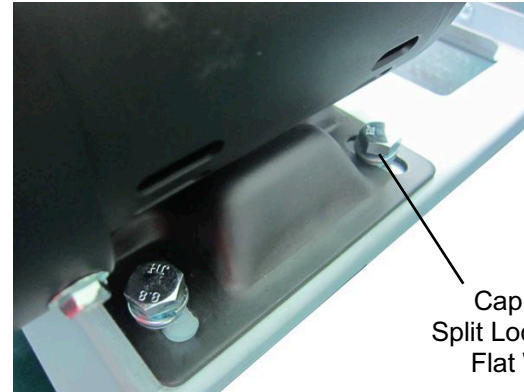

Cap Screws (4),
Split Lock Washers (4),
Flat Washers (4)

6. Remove the M8 Hex Cap Screws (4), the M8 Split Lock Washers (4), and the Flat Washers (4).
7. Remove the old Punch Motor.

Installation Procedure

1. Using the position marks on the Bracket, place the new Punch Motor in position.



Mark

2. Place the Flat Washers (4) and the M8 Split Lock Washers (4) in position.
3. Tighten the M8 Hex Cap Screws (4).
4. Do REP 3.3 Punch Motor Belt Replacement (Timing Belt) to install the Punch Motor Belt.
5. Do REP 3.1 to install the Punch Module.
6. Do REP 1.6 to install the Rear Cover.
7. Connect the Power Cord.
8. Power ON the entire printing system.

REP 3.3 Punch Motor Belt Replacement (Timing Belt)

PARTS LIST ON PL 5.1 (page 2)

Use this procedure to remove and install the Punch Motor Belt.

- (Belt, Timing, Punch Pulley, 115V)
- Belt, Timing, Punch Pulley, 230V

WARNING

Do not perform repair activities with the power on or electrical power supplied to the machine. Some machine components contain dangerous electrical voltages that can result in electrical shock and possible serious injury. See Section 0, page vi for other languages.

1. Switch power OFF to entire printing system.
2. Disconnect the Power Cord.
3. Do REP 1.6 to remove the Rear Cover.
4. There is no need to uninstall the punch module, however for ease of operation it is recommended to uninstall it, using REP 3.1
5. Remove the E-Ring, nylon washer and ball bearing.

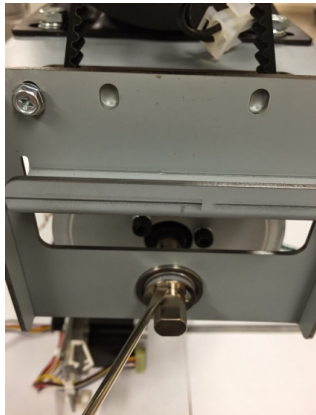

6. Remove the Screws (2) and the Bearing Bracket.

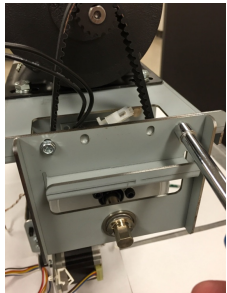

7. Remove the old Belt.
8. Place the new Belt around the Clutch Pulley.

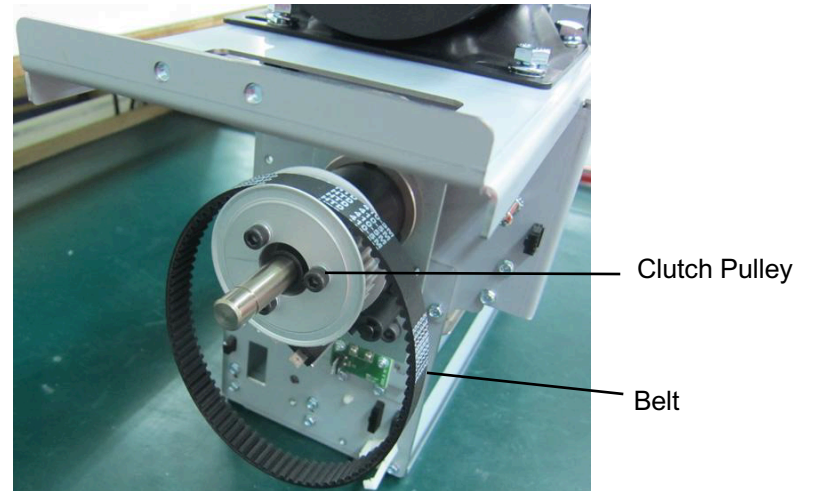

9. Place the new Belt around the Timing Pulley on the Punch Motor.

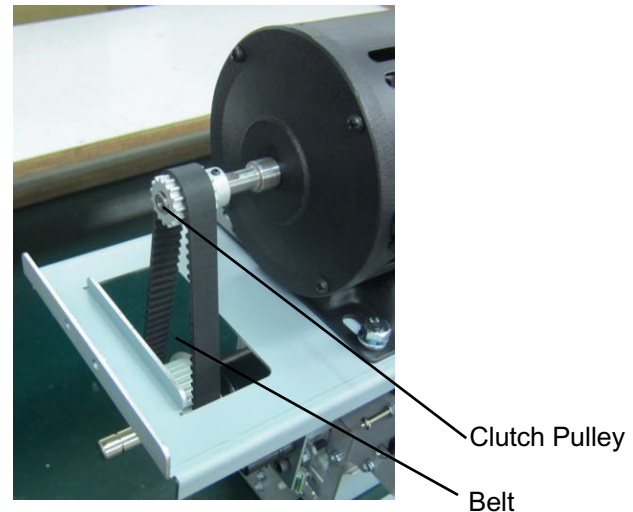

(Cont.)

10. Place the Bearing Bracket in position and tighten the Screws (2).
11. Place the Ball Bearing in position.
12. Place the Nylon Washer in position.
13. Place the E-Ring in position.

NOTE: The tension on the Belt is set using the reference marks on the punch motor bracket (see REP 3.2).



14. Do REP 1.6 to install the Rear Cover.
15. Connect the Power Cord.
16. Power ON the entire printing system.

REP 3.4 Clutch or Clutch Pulley Replacement

PARTS LIST ON PL 5.6

Use this procedure to remove and install the Clutch or the Clutch Pulley in the Punch Module.

Removal Procedure

WARNING

Do not perform repair activities with the power on or electrical power supplied to the machine. Some machine components contain dangerous electrical voltages that can result in electrical shock and possible serious injury. See Section 0, page vi for other languages.

1. Switch power OFF to entire printing system.
2. Disconnect the Power Cord.
3. Do REP 1.6 to remove the Rear Cover.
4. Do REP 3.1.1 Punch Module Removal.
5. Remove the E-Ring, nylon washer and ball bearing.

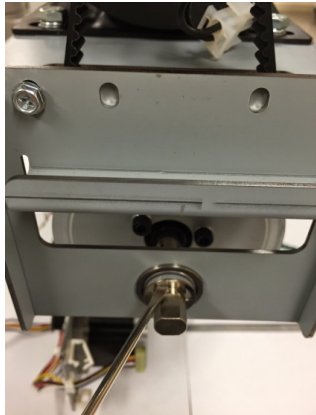

6. Remove the Screws (2) and the Bearing Bracket.

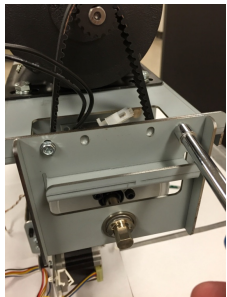

7. Remove the Timing belt.

8. To remove the Clutch Pulley
 - Remove the M5X18 Screws (3) and Split Lock Washer (3)
 - Remove the Pulley and Flange.

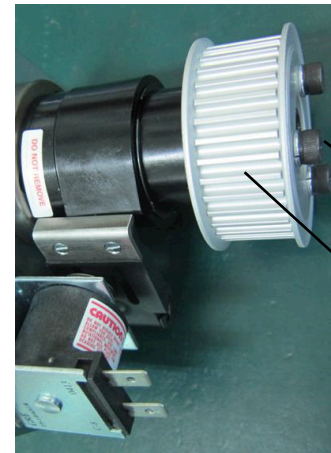

Screws
Pulley and Flange

9. Remove the Lock Nut and the long M6 Screw.

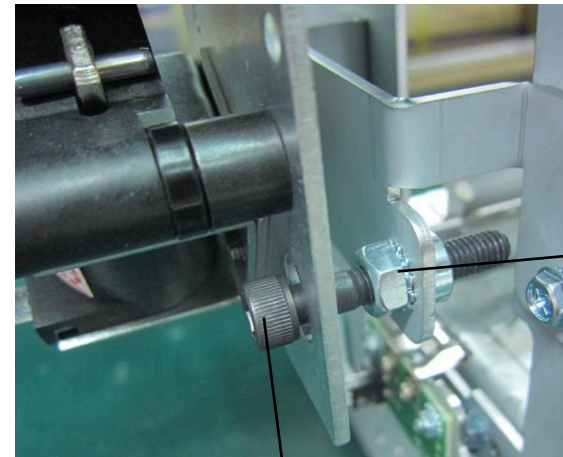

(Cont.)
Screw
Lock Nut (2)

10. Loosen the Set Screws (2) from the Clutch.

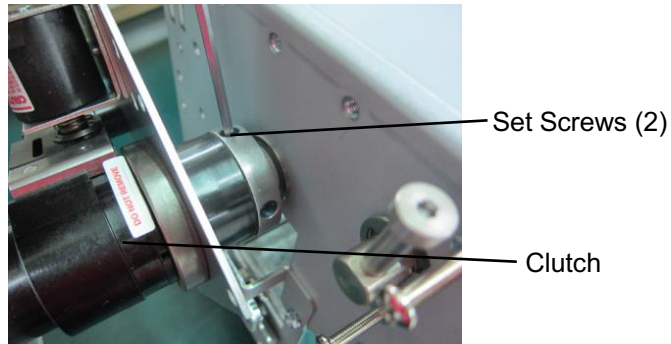

11. Remove the Clutch from the Shaft.

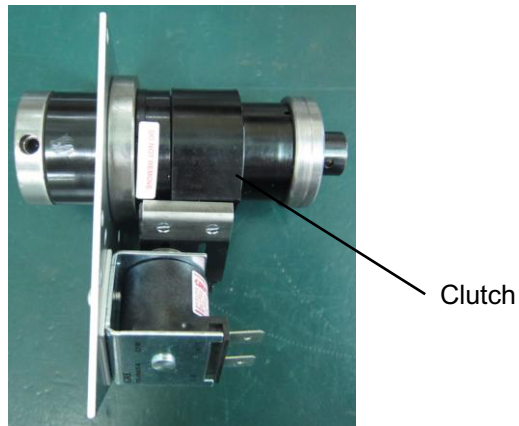

Installation Procedure

1. Loosen the Set Screws (2) from the new Clutch.
2. Place the new Clutch in position on the Shaft.
3. Rotate the Clutch until the holes for the Set Screws line up with the notches on the Shaft.
The Cone point set screw should be properly seated in the notch of the Punch shaft.
4. Put a drop of Loctite on each Set Screw.
5. Tighten the Set Screws (2).
6. Place the long M56Screw and the Lock Nuts (2) in position.

7. Use a shim of thickness between 3 and 5mm to set the gap between the head of the Screw and the Clutch Bracket.

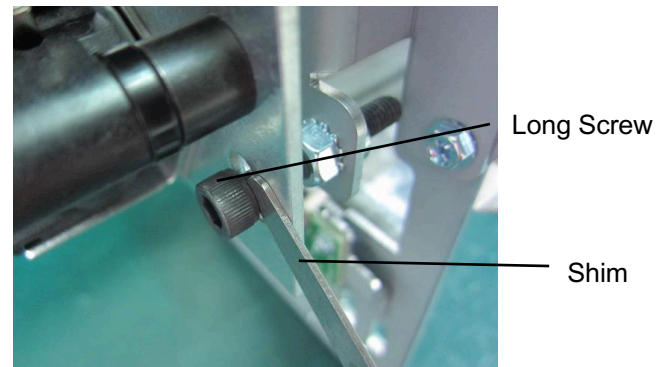

8. Use a 10 mm wrench and a 6mm Allen Wrench to tighten the Lock Nuts (2).

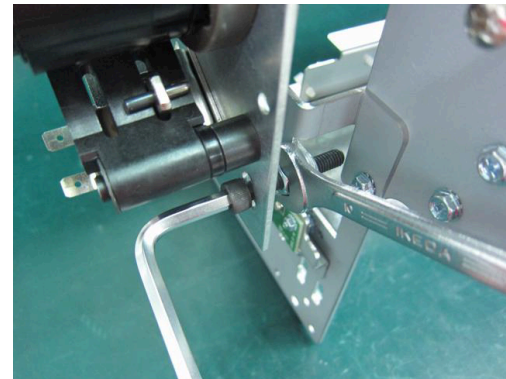

9. Recheck the gap.
10. Do ADJ 1.5 Punch Cam Indexing.
(Cont.)

11. To replace the Clutch Pulley

- Place the Pulley and Flange in position.
- Tighten the M5X18 Screws (3) with the Split Lock Washers (3).

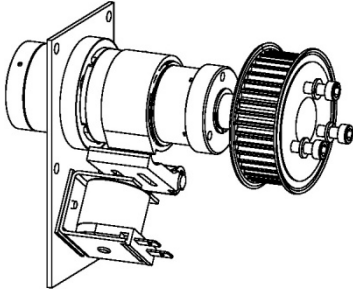

12. Place the Punch Shaft Bearing Bracket in position and tighten the Screws (2).

13. Do REP 3.3 to install the Punch Motor Belt.

14. Do **Error! Reference source not found.** Ball Bearing Replacement to install the Ball Bearing.

15. Do REP 3.1.2 Punch Module Installation.

16. Do REP 1.6 to install the Rear Cover.

17. Connect the Power Cord.

18. Power ON the entire printing system.

REP 3.5 Punch Alignment Stepper Motor and Pulley Replacement

PARTS LIST ON PL 5.1

Use this procedure to remove and install the Punch Alignment Stepper Motor (M5) and Pulley, or the Alignment Stepper Mount Bracket.

Removal Procedure

WARNING

Do not perform repair activities with the power on or electrical power supplied to the machine. Some machine components contain dangerous electrical voltages that can result in electrical shock and possible serious injury. See Section 0, page vi for other languages.

1. Switch power OFF to entire printing system.
2. Disconnect the Power Cord.
3. Do REP 1.6 to remove the Rear Cover.
4. Do REP 3.1 to remove the Punch Module.

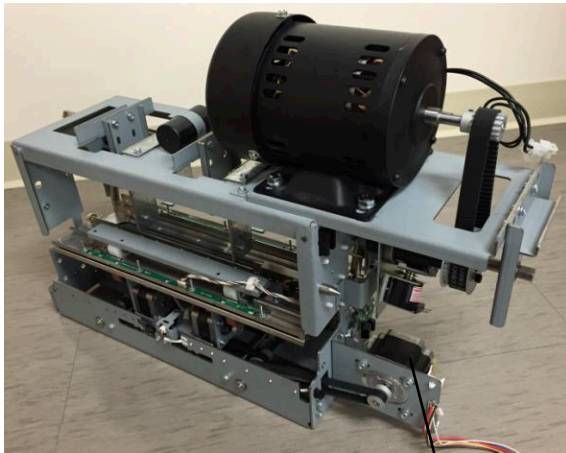

Punch Alignment Stepper Motor (M5)

5. Remove the Phillips Screws (4).

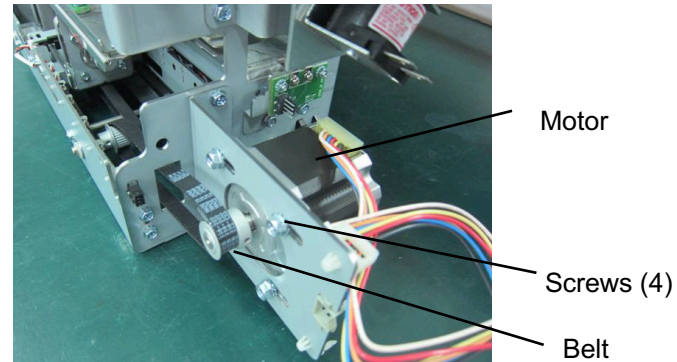

6. Remove the Steering Belt from the Pulley.
7. Remove the Punch Alignment Stepper Motor and Pulley.

Installation Procedure

1. Place the Steering Belt around the Pulley.
2. Do ADJ 1.4.1 to adjust the tension on the Belt.
3. Tighten the Phillips Screws (4).
4. Do REP 3.1 to install the Punch Module.
5. Close the Front Door.
6. Do REP 1.6 to install the Rear Cover.
7. Connect the Power Cord.
8. Power ON the entire printing system.

REP 3.6 Steering Module Replacement

PARTS LIST ON PL 5.1

Use this procedure to remove and install the Steering Module Sub Assembly.

Removal Procedure

WARNING

Do not perform repair activities with the power on or electrical power supplied to the machine. Some machine components contain dangerous electrical voltages that can result in electrical shock and possible serious injury. See Section 0, page vi for other languages.

1. Switch power OFF to entire printing system.
2. Disconnect the Power Cord.
3. Do REP 1.6 to remove the Rear Cover.
4. Do REP 3.1 to remove the Punch Module.

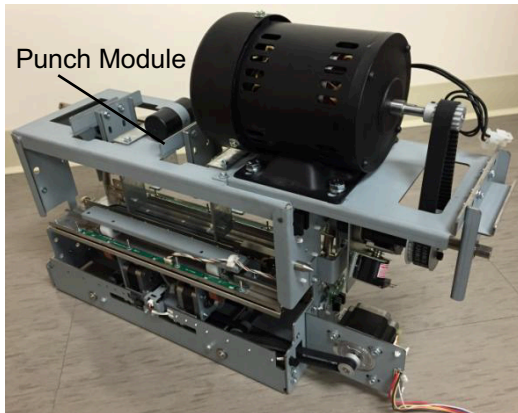

5. Disconnect the Skew Sensor Board Connector.

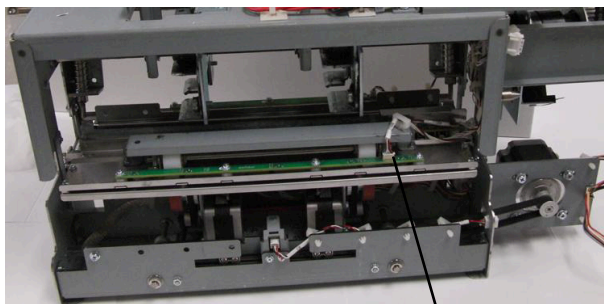

Skew Sensor Board Connector

6. Do the following to take the Alignment motor Belt off the Pulley.
 - Remove the Phillips Screws (2) from Alignment motor bracket.

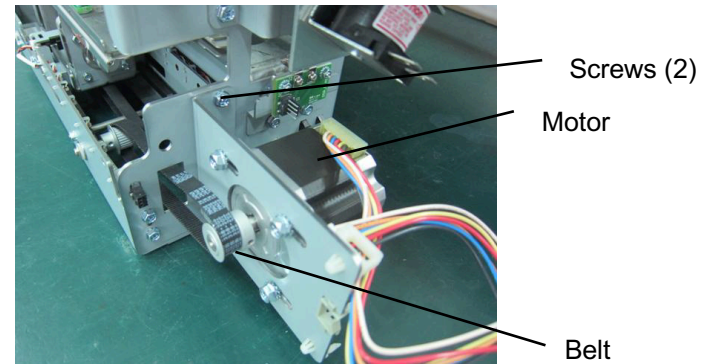

- Remove the Steering Belt from the Pulley.

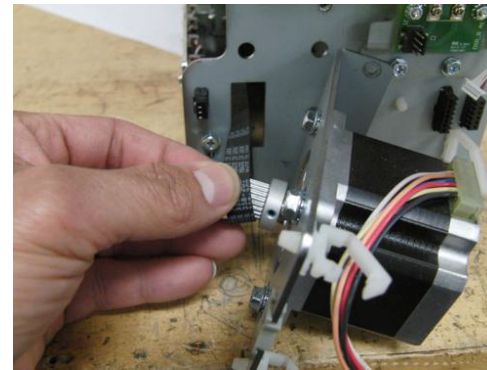

7. Pull the Steering Belt in through the hole in the Frame.

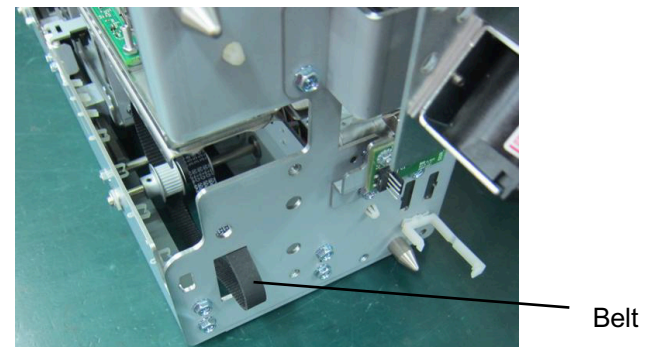

8. Disconnect the Left/Right Steering Stepper Connectors at the Punch Frame. One of the Connectors has 6 pins the other has 7 pins.
 - Push the connector towards the outside of the frame.

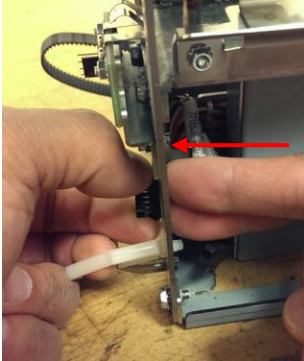

- Press down on the top tab to remove it from the top side. Then press the bottom tab to release the connector fully.

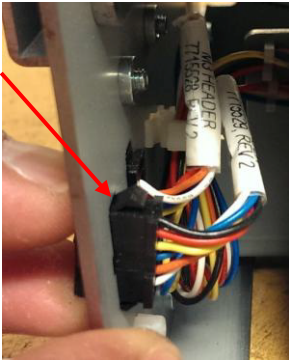

- Similarly disconnect the Align Home sensor connector.



9. Release the Cable Clamp for Steering Stepper wires.
10. Remove the Phillips Screws (8).

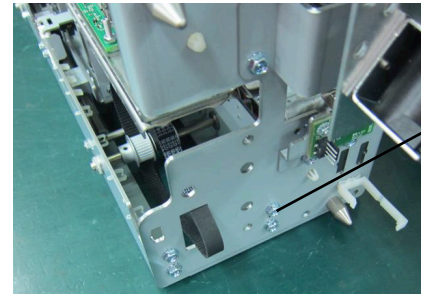

Screws (8)-
(4) on front side,
(4) on rear side

11. Remove the Steering Module from the Punch Module, by tilting the Steering Module as shown.
12. Remove the Steering Module from the Punch Module, by tilting the Steering Module as shown. This is to ensure the back side clears the self clinching nut.

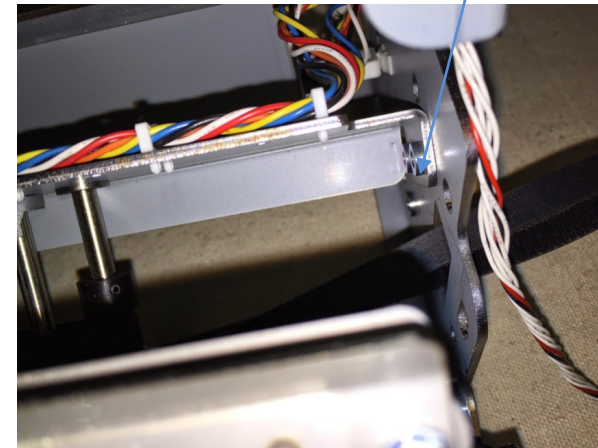

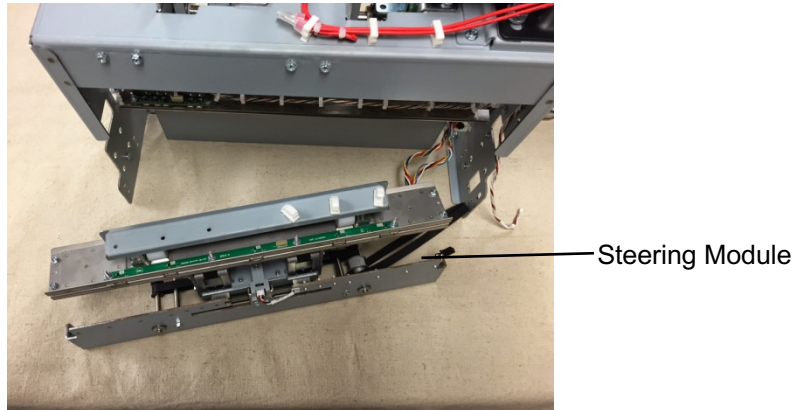

Installation Procedure

1. Place the Steering Module into the Punch Module.
2. Push the Steering Belt out through the hole in the Frame.
3. Install the Phillips Screws (8).
When installing (8) screws that hold the die rail, use 3mm reference holes for positioning the part. A 3mm pin can be inserted to hold the part in position while the screws are tightened.
4. Connect the Alignm Home Sensor and the Left/Right Steering Motor Connectors.
5. Place the Alignment Stepper motor Belt around the Pulley.
6. Tighten the Phillips Screws (2).
7. Do REP 3.1 to install the Punch Module.
8. Close the Front Door.
9. Do REP 1.6 to install the Rear Cover.
10. Connect the Power Cord.
11. Power ON the entire printing system.

REP 3.7 Alignment Carriage Sub Assembly Replacement

PARTS LIST ON PL 5.3

Use this procedure to remove and install the Alignment Carriage Sub Assembly.

Removal Procedure

WARNING

Do not perform repair activities with the power on or electrical power supplied to the machine. Some machine components contain dangerous electrical voltages that can result in electrical shock and possible serious injury. See Section 0, page vi for other languages.

1. Switch power OFF to entire printing system.
2. Disconnect the Power Cord.
3. Do REP 1.6 to remove the Rear Cover.
4. Do REP 3.1.1 to remove the Punch Module.

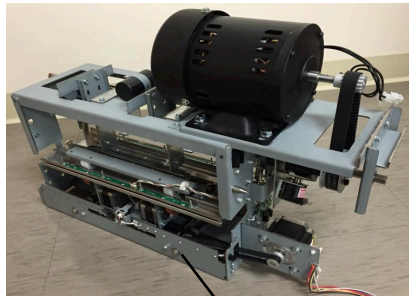

Steering Module

5. Remove the Steering Idler and Drive Panel assemblies by removing the M3 Nuts (4)

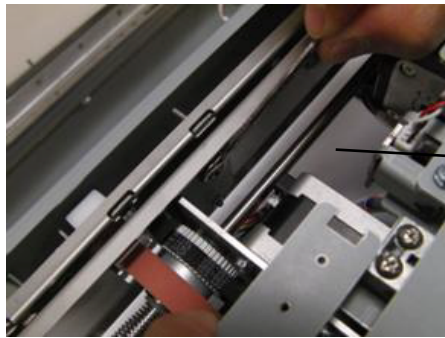

Steering Idler

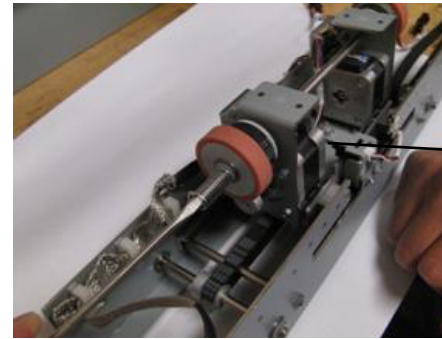

Drive Panel

6. Remove E-clip from steering drive roller shaft.

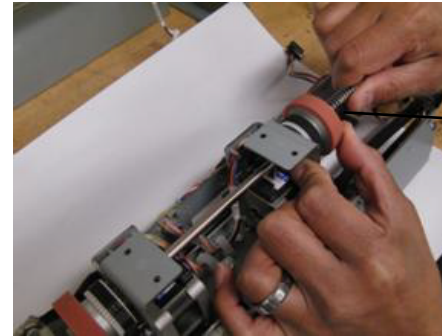

E-Ring

7. Remove the drive roller shaft and all the components on the drive shaft. (4 plastic washers; 2 springs; 2 drive rollers; 2 belts; 2 e-clips)

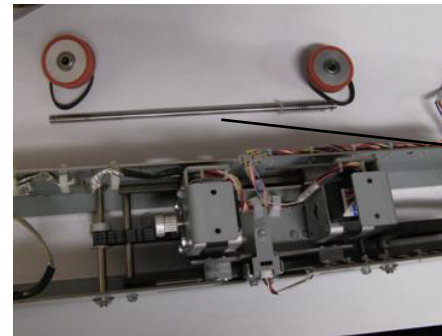

Drive Roller Shaft

8. Remove Align Home Sensor Bracket sub assembly by removing the screws (2) and its cable.

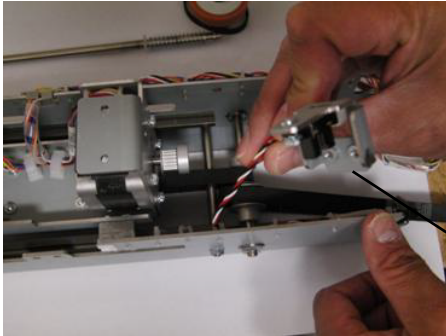

Align Home Sensor Bracket

9. Remove Left and Right Steering Stepper Motors along with their corresponding cables, by removing the Screws (8).

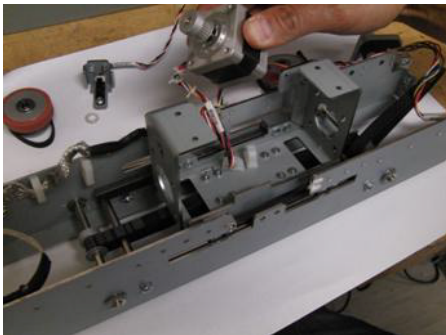
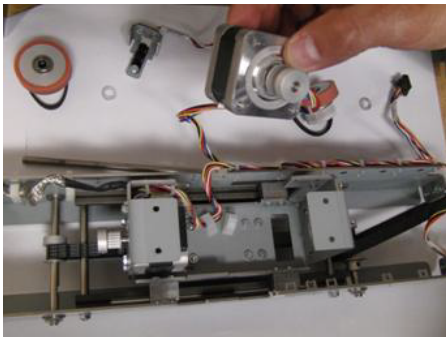

Installation Procedure

1. Install the parts that were removed in the new Alignment Carriage Sub assembly.

Installation tip:

The cable of the motor closer to the ground strap has a 7 pin connector (the other cable has a 6 pin connector).

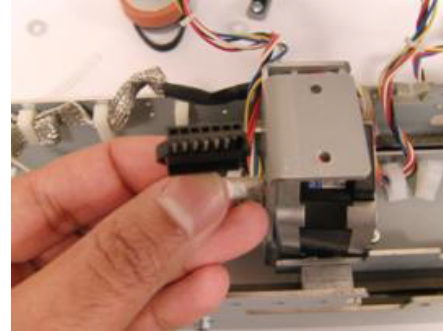

2. Do ADJ 1.4.5 and ADJ 1.4.1 to adjust the tension on the timing belts installed.
3. Do REP 3.1.2 to install the Punch Module.
4. Do REP 1.6 to install the Rear Cover.
5. Connect the Power Cord.
6. Close the Front Door.
7. Power ON the entire printing system.

REP 3.8 Steering Stepper Motor Replacement

PARTS LIST ON PL 5.5

Use this procedure to remove and install the Front/Left Stepper Motor (M3) or the Rear/Right Stepper Motor (M4).

Removal Procedure

WARNING

Do not perform repair activities with the power on or electrical power supplied to the machine. Some machine components contain dangerous electrical voltages that can result in electrical shock and possible serious injury. See Section 0, page vi for other languages.

1. Switch power OFF to entire printing system.
2. Disconnect the Power Cord.
3. Do REP 1.6 to remove the Rear Cover.
4. Do REP 3.1 to remove the Punch Module.
5. Do REP 3.6 to remove the Steering Module.

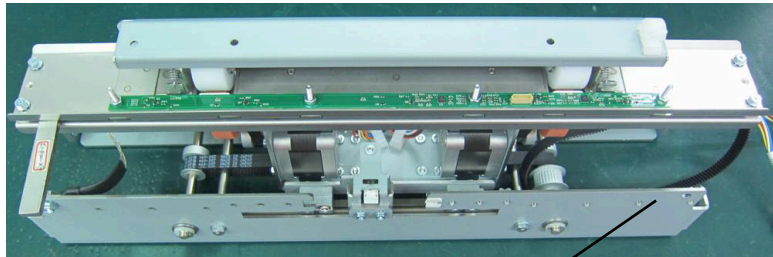

Steering Module

6. Disconnect the Steering Motor Cable at the Motor and at the Header,

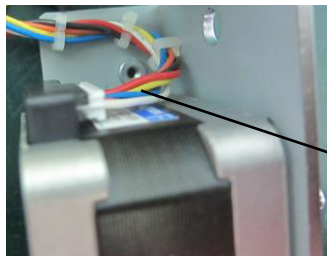

Steering Motor Cable

7. Remove the M3 Screws (2) and the Align Home Sensor Bracket to create more room.

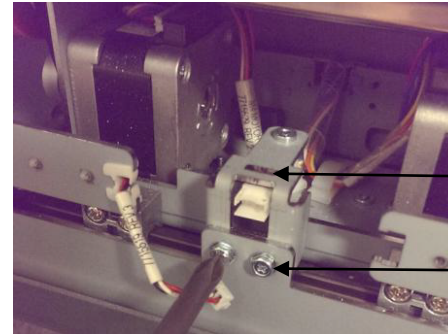

Sensor Bracket

Screws (2)

8. Remove the M3 Phillips Head Screws (4).

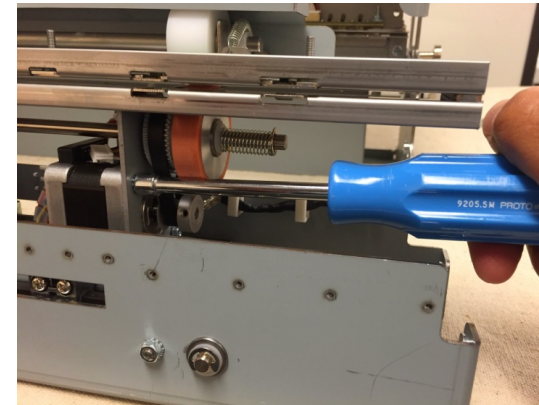

9. Remove the Motor.

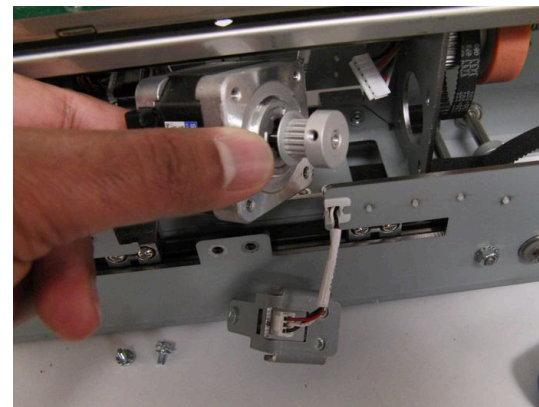

Installation Procedure

1. Place the new Motor in positions and tighten the Screws (4).
2. Do ADJ 1.4 to set the belt tension.
3. Connect the Steering Motor Cable at the Motor and at the Header.
4. Install the Screws (4) and tighten with the Belt in place.
5. Install the Align Home Sensor Bracket and tighten the M3 Screws (2).
6. Do REP 3.6 to install the Steering Module.
7. Do REP 3.1 to install the Punch Module.
8. Do REP 1.6 to install the Rear Cover.
9. Close the Front Door.
10. Connect the Power Cord.
11. Power ON the entire printing system.

REP 3.9 Steering Motor Belt (65 Groove) Replacement

PARTS LIST ON PL 5.5

Use this procedure to remove and install a 65 Groove Steering Belt, the Steering Drive Roller Assembly or the Steering Drive Roller Spring.

Removal Procedure

WARNING

Do not perform repair activities with the power on or electrical power supplied to the machine. Some machine components contain dangerous electrical voltages that can result in electrical shock and possible serious injury. See Section 0, page vi for other languages.

1. Switch power OFF to entire printing system.
2. Disconnect the Power Cord.
3. Do REP 1.6 to remove the Rear Cover.
4. Do REP 3.1 to remove the Punch Module.

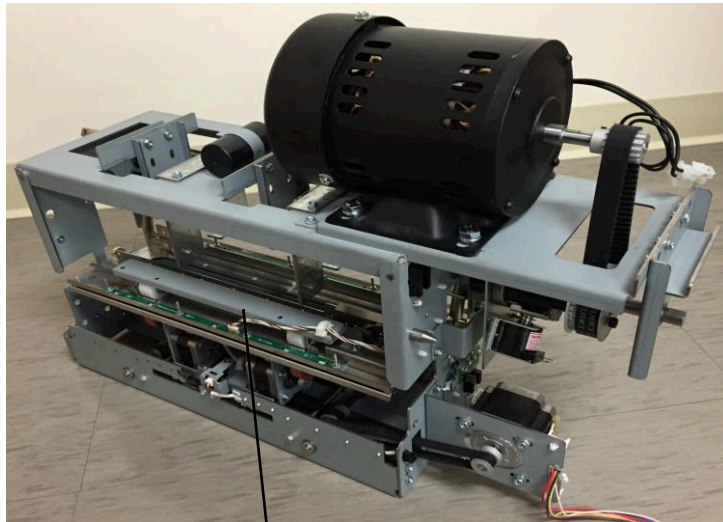

Drive Panel Steering Sub Assembly

5. Remove the E-Ring from the Steering Drive Roller shaft (from the side that needs the part to be replaced).

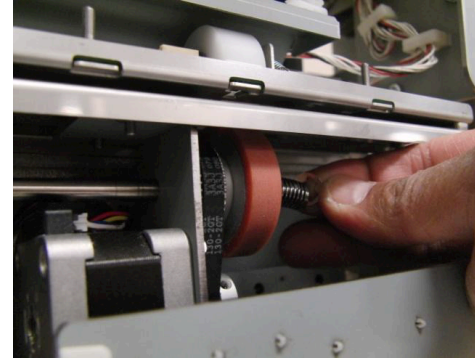

6. Slide the Shaft in the opposite direction so that the Steering Drive Roller Spring, (2) plastic washers and Steering Drive Roller can be removed (from the side that needs the part replaced).

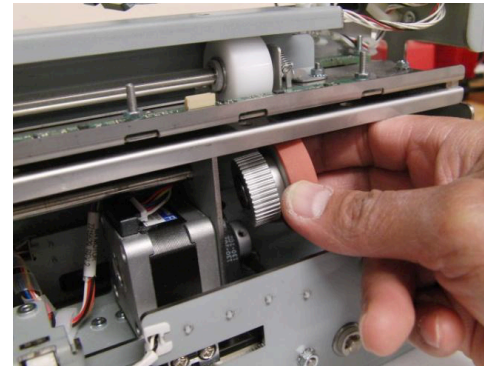

If necessary, loosen (4) screws of the Stepper motor and move the motor up.

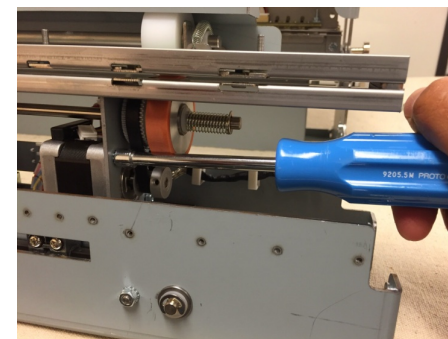

With the above parts removed, one or more of the below parts can be replaced:

- 65 Groove Steering Belt
- Steering Drive Roller
- Steering Drive Roller Spring.

Intallation Procedure

1. Place the belt around the Timing Pulley.
2. Do ADJ 1.4.5 to set the belt tension.
3. Install the Steering Drive Roller and the Flat Washers (2), and the Spring on the end of the Shaft.
4. Install the E-Ring on the Steering Drive Roller Shaft.
5. Do REP 3.1 to install the Punch Module.
6. Do REP 1.6 to install the Rear Cover.
7. Connect the Power Cord.
8. Power ON the entire printing system.

REP 3.10 Steering Idler Panel Weldment Replacement

PARTS LIST ON PL 5.4

Use this procedure to remove and install a Steering Idler Panel Weldment.

Removal Procedure

WARNING

Do not perform repair activities with the power on or electrical power supplied to the machine. Some machine components contain dangerous electrical voltages that can result in electrical shock and possible serious injury. See Section 0, page vi for other languages.

1. Switch power OFF to entire printing system.
2. Disconnect the Power Cord.
3. Do REP 1.6 to remove the Rear Cover.
4. Do REP 3.1 to remove the Punch Module.

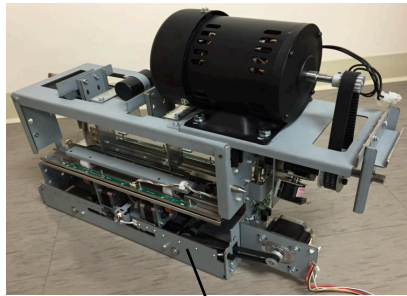

Steering Module

5. Unplug the Skew Sensor and release the Cable Clamp.

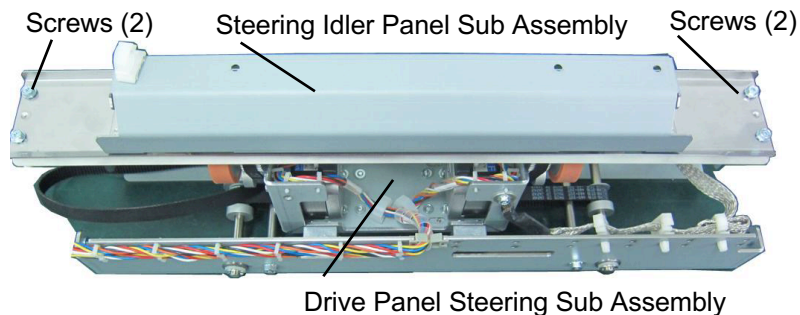

6. Remove the Screws (4) that hold the Steering Idler Panel Sub Assembly to the Drive Panel Steering Sub Assembly.

7. Remove the Steering Idler Panel Sub Assembly.



Steering Idler Panel Sub Assembly

8. Transfer the Skew Sensor, Steering Idler Roller, Idler roller Cover, and all fasteners to the new Weldment.

Installation Procedure

1. Make sure the Spacers (2) are in position on the Steering Drive Panel Weldment (use semi perfs for placement).

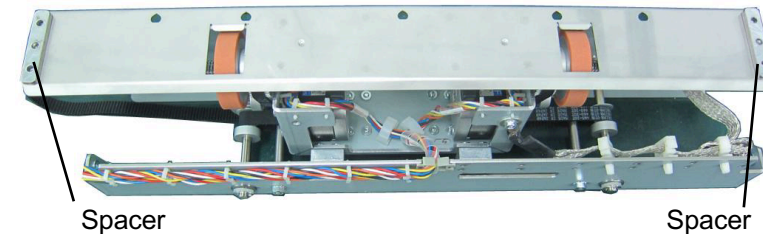

2. Place the Steering Idler Panel Sub Assembly in position on the Drive Panel Steering Sub Assembly.
3. Install the Screws (4).
4. Do REP 3.1 to install the Punch Module.
5. Do REP 1.6 to install the Rear Cover.
6. Connect the Power Cord.
7. Power ON the entire printing system.

REP 3.11 Steering Idler Roller Assembly Replacement

PARTS LIST ON PL 5.4

Use this procedure to remove and install a Steering Idler Roller Assembly.

Removal Procedure

WARNING

Do not perform repair activities with the power on or electrical power supplied to the machine. Some machine components contain dangerous electrical voltages that can result in electrical shock and possible serious injury. See Section 0, page vi for other languages.

1. Switch power OFF to entire printing system.
2. Disconnect the Power Cord.
3. Do REP 1.6 to remove the Rear Cover.
4. Do REP 3.1 to remove the Punch Module.

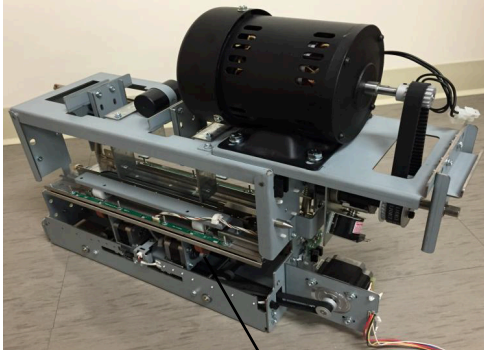

Steering Idler Roller Assembly

5. Disconnect the Skew Sensor Board Connector.

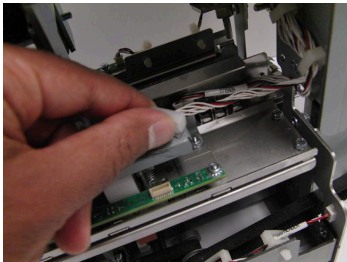

6. Release the Cable Clamp and move the Cable out of the way.
7. Remove the M4 Nuts (2).

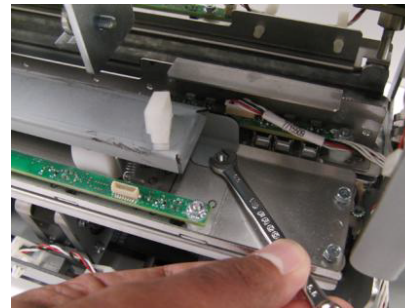
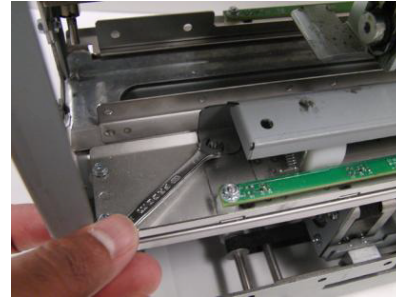

8. Remove the Roller Cover.

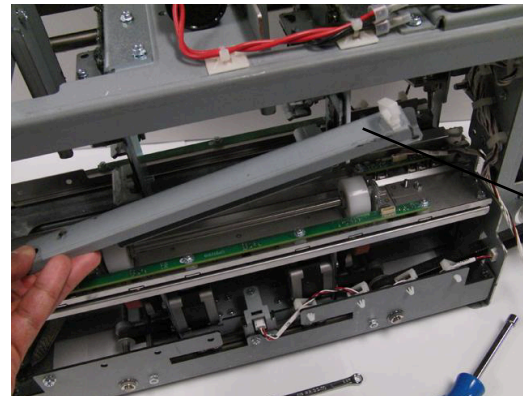

9. Gently move the Springs (2) off the ends of the Roller.

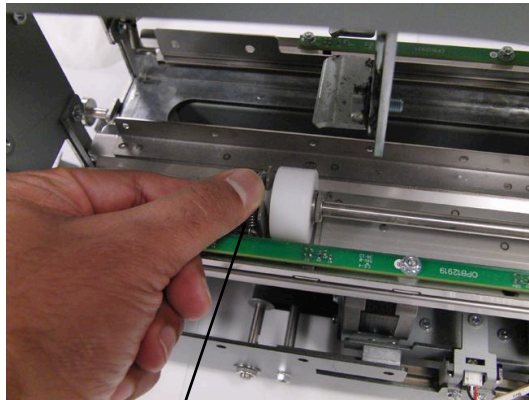

Spring

10. Remove the Roller Assembly.

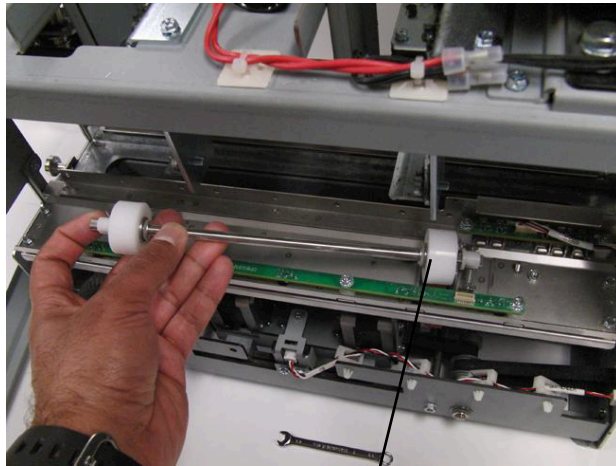

Steering Idler Roller Assembly

Installation Procedure

1. Place the new Roller Assembly in position.
2. Gently move the Springs (2) on to the ends of the Roller.

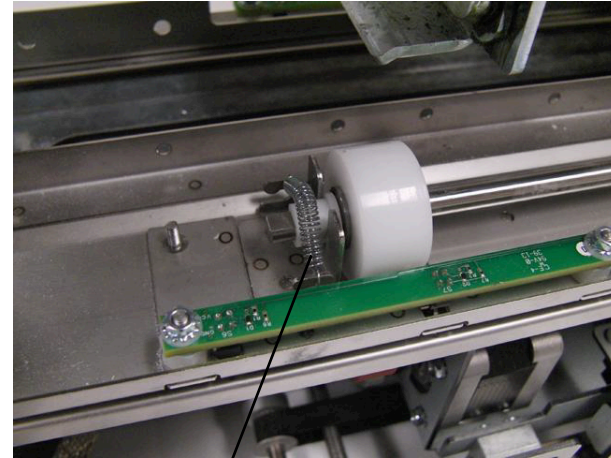

Spring

3. Ensure the Springs (2) are over the white Roller Bushings (2).
4. Place the Roller Cover in position.
5. Install and tighten the M4 Nuts (2).
6. Place the Skew Sensor Board Cable in the Cable Clamp and close the Cable Clamp.
7. Connect the Skew Sensor Board Connector.
8. Do REP 3.1 to install the Punch Module.
9. Do REP 1.6 to install the Rear Cover.
10. Connect the Power Cord.
11. Power ON the entire printing system.

REP 3.11.1 Steering Idler Roller Bearing Replacement

PARTS LIST ON PL 5.4

Use this procedure to remove and install a Steering Idler Roller Double "D" Flange Bearing.

WARNING

Do not perform repair activities with the power on or electrical power supplied to the machine. Some machine components contain dangerous electrical voltages that can result in electrical shock and possible serious injury. See Section 0, page vi for other languages.

1. Do REP 3.11 Steering Idler Roller Replacement to remove the Steering Idler Roller.

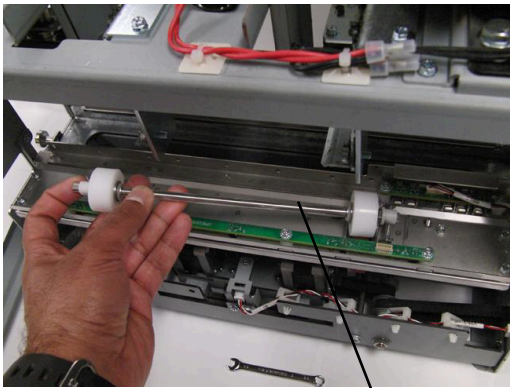

Steering Idler Roller Assembly

2. Remove the Steering Idler Roller Bearing (2) from the ends of Shaft on the Steering Idler Roller Assembly.

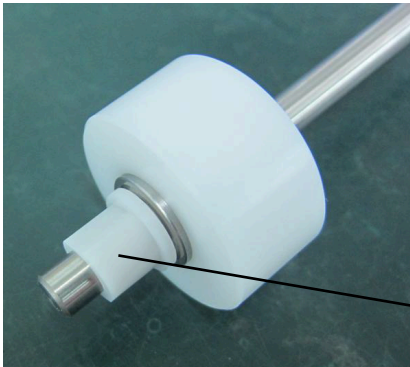

Steering Idler Roller Bearing

3. Place the new Steering Idler Roller Bearing (2) on to the ends of Shaft on the Steering Idler Roller Assembly.
4. Do REP 3.11 Steering Idler Roller Replacement to install the Steering Idler Roller.

REP 3.12 Steering Drive Panel Weldment Replacement

PARTS LIST ON PL 5.5

Use this procedure to remove and install the Steering Drive Panel Weldment.

WARNING

Do not perform repair activities with the power on or electrical power supplied to the machine. Some machine components contain dangerous electrical voltages that can result in electrical shock and possible serious injury. See Section 0, page vi for other languages.

Removal Procedure

1. Switch power OFF to entire printing system.
2. Disconnect the Power Cord.
3. Do REP 1.6 to remove the Rear Cover.
4. Do REP 3.10 (through step 6) to remove the Steering Idler Panel Sub Assembly.

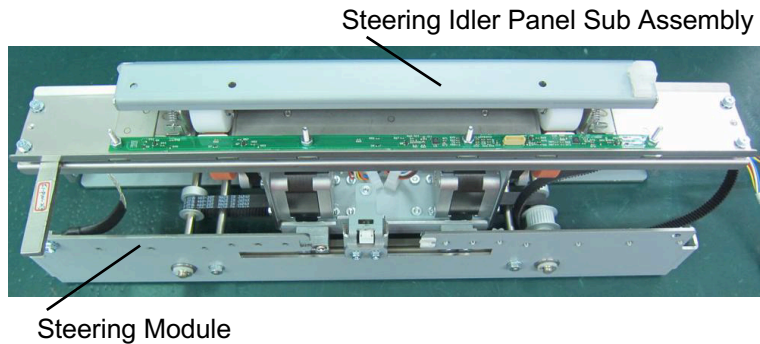

5. Remove the Spacers (2).

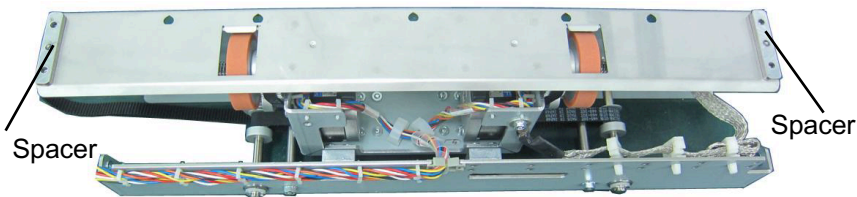

6. Remove the Nuts (4) holding the Steering Drive Panel Weldment.

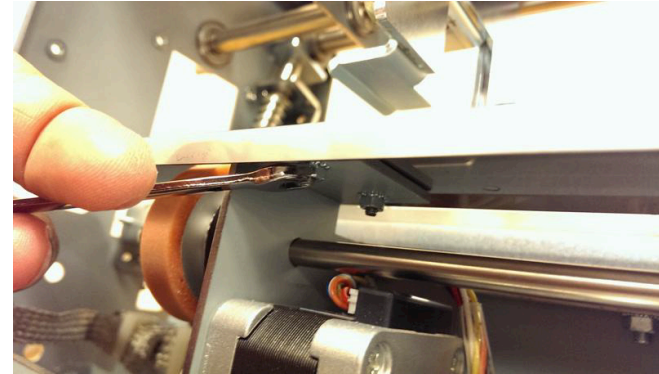

7. Replace with new part

Installation Procedure

1. Place the Steering Drive Panel Weldment in place.
2. Tighten the Nuts (4) that hold the Steering Drive Panel Weldment.
3. Install the Spacers (2).
4. Do REP 3.10 to install the Steering Idler Panel Sub Assembly.
5. Do REP 1.6 to install the Rear Cover.
6. Connect the Power Cord.
7. Power ON the entire printing system.

REP 3.13 Die Lock Plunger and Stripper Assembly Replacement PARTS LIST ON PL 5.1 (page 2)

Use this procedure to remove and install the Die Lock Plunger and Stripper Assembly or the Die Lock Bracket.

Removal Procedure

WARNING

Do not perform repair activities with the power on or electrical power supplied to the machine. Some machine components contain dangerous electrical voltages that can result in electrical shock and possible serious injury. See Section 0, page vi for other languages.

1. Switch power OFF to entire printing system.
2. Disconnect the Power Cord.
3. Do REP 1.6 to remove the Rear Cover.
4. Do REP 3.1 to remove the Punch Module.

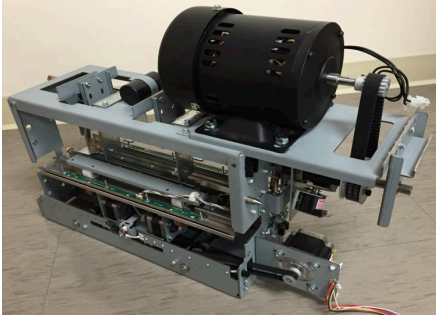

5. Remove the left or right Die Lock Bracket Screws (2).

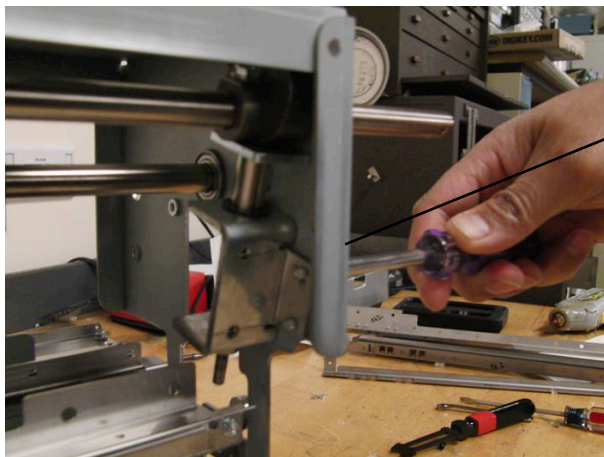

Screws (2)

6. Note the orientation of the Stripper Pad.

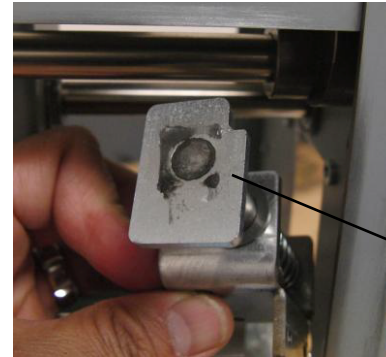

Stripper Pad

7. To replace the components in the Die Lock Plunger and Stripper,
 - Remove the E-Clip



E-Clip

- Pull the Die Lock Plunger and Stripper out.



Die Lock Plunger and Stripper

Installation Procedure

8. Install the Plunger and Stripper Assy.
9. Do REP 3.1 to install the Punch Module.
10. Do REP 1.6 to install the Rear Cover.
11. Connect the Power Cord.
12. Power ON the entire printing system.
13. .

REP 3.14 Die Lock Shaft Replacement

PARTS LIST ON PL 5.1

Use this procedure to remove and install the Die Lock Shaft.

Removal Procedure

WARNING

Do not perform repair activities with the power on or electrical power supplied to the machine. Some machine components contain dangerous electrical voltages that can result in electrical shock and possible serious injury. See Section 0, page vi for other languages.

1. Remove the Die Set (see Operator Manual).
2. Switch power OFF to entire printing system.
3. Disconnect the Power Cord.
4. Do REP 1.6 to remove the Rear Cover.
5. Remove the Phillips Screw and the Die Stop Handle.



Die Lock Shaft

Die Lock Handle

6. Do REP 3.1 to remove the Punch Module.

7. Remove the Shoulder Screw from the hole in the Shaft at the rear of the Punch Module.



Shoulder Screw

8. Remove the Socket Head Cap Screw and Split Lock Washer from the Cam and the Shaft at the rear of the Punch Module.

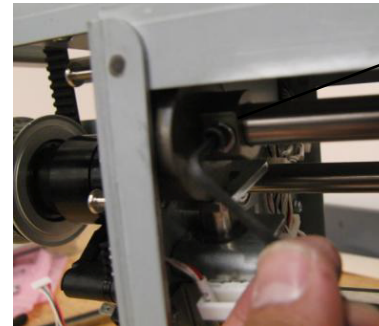

Screw

9. Remove the Socket Head Cap Screw and Split Lock Washer from the Cam and the Shaft at the front of the Punch Module.



Screw

10. Remove the E-Ring from the Shaft at the rear of the Punch Module.

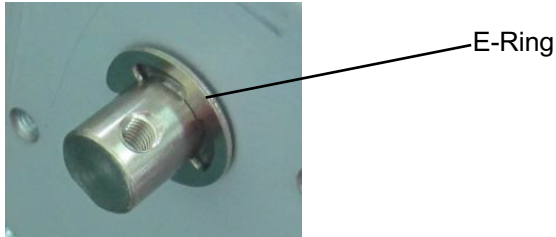

11. Remove the E-Ring from the Shaft at the front of the Punch Module.

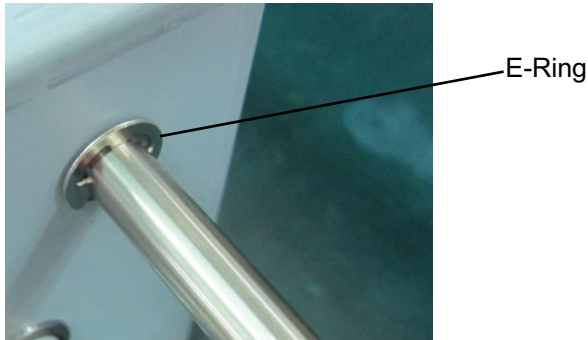

12. Pull the Shaft out through the Cams (2) and out of the Punch Module.

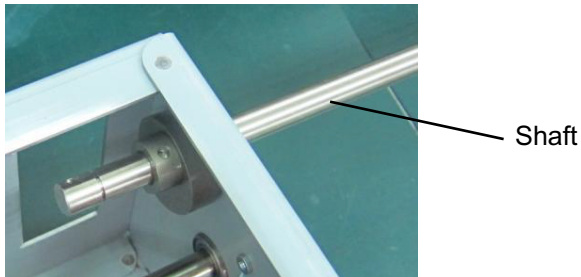

5. Insert the E-Ring on the Shaft at the rear of the Punch Module.
6. Insert the Socket Head Cap Screw and Split Lock Washer into the Cam and the Shaft at the front of the Punch Module.
7. Insert the Phillips Screw into the Cam and the Shaft at the rear of the Punch Module.
8. Insert the Shoulder Screw the hole in the Shaft at the rear of the Punch Module. Make sure it is in the correct phase (Shoulder Screw facing down as well as Cam Screws facing down).
9. Place a Lock Nut on each of the M4X25 Phillips Head Pan Screws (2), then insert the Screws into the holes in rear of the Punch Module.
10. Tighten the Screws (2) until they are flush with the Nut inside the Punch Module.
11. Place the Punch Module in an upright position.

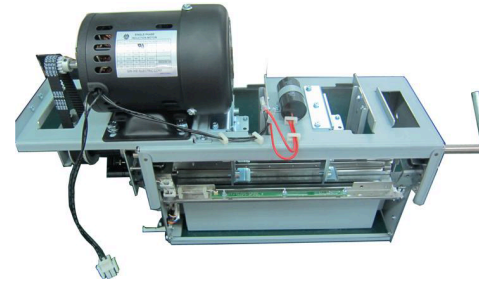

12. Do REP 3.1 to install the Punch Module.
13. Insert the Die Lock Handle into the Shaft at the front of the Punch Module, and tighten the Screw.
14. Install the Die Set (see Operator Manual).
15. Do REP 1.6 to install the Rear Cover.
16. Connect the Power Cord.
17. Power ON the entire printing system.

Installation Procedure

1. Place a Die Lock Cam inside the Punch Module by the hole at the front of the Punch Module (cam portin against side Frame).
2. Insert the Die Lock Shaft through the hole at the front of the Punch Module and through the hole in the Cam.
3. Push the Shaft through the Punch Module, through the hole in the other Cam, and out through the hole in the rear of the front of the Punch Module (cam portin against side Frame)
4. Insert the E-Ring on the Shaft at the front of the Punch Module.

REP 3.15 Die Rail Assembly and Die Rail Springs Replacement

PARTS LIST ON PL 5.7

Removal Procedure

Use this procedure to remove and install the Die Rail Assembly and Die Rail Springs

WARNING

Do not perform repair activities with the power on or electrical power supplied to the machine. Some machine components contain dangerous electrical voltages that can result in electrical shock and possible serious injury. See Section 0, page vi for other languages.

1. Switch power OFF to entire printing system.
2. Remove the Die Set (see Operator Manual).
3. Disconnect the Power Cord.
4. Do REP 1.6 to remove the Rear Cover.
5. Do REP 3.1 to remove the Punch Module.
6. Unplug Back Gage Sensor Board and release the wires from cable clamps.

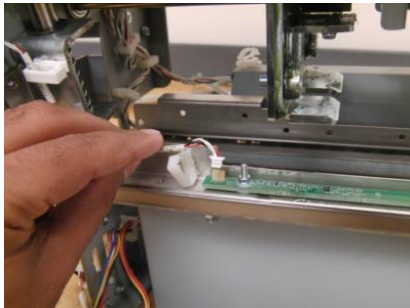

7. Unplug Alignment Sensor Board and release the wires from the Cable Clamps.

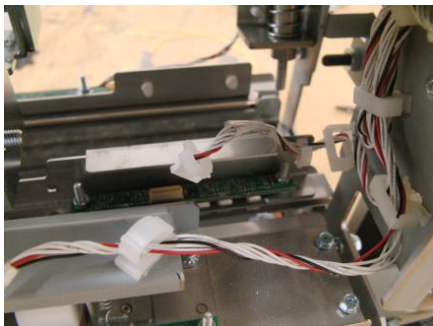

8. Remove the Screws (2) that hold the Dieset Recognition Bracket.



9. Remove the Screws (4) that hold that Die Rail Assembly- (2) from the front and (2) from the rear.

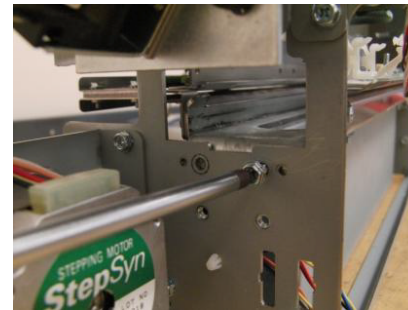

10. Remove the Die Rail Assembly.

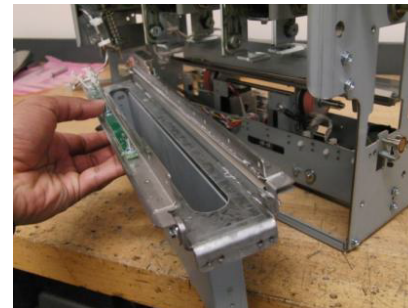

11. Remove all brackets from both sides.

If replacing only the Die rail springs, remove only the brackets from the Alignment sensor side.

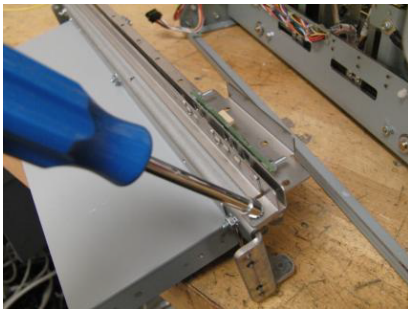
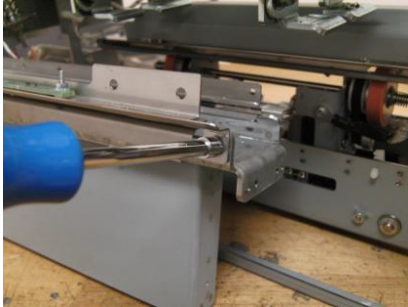

12. Unscrew the M2 Screws (4) and M2 Lock Washers (4) to remove the Springs.

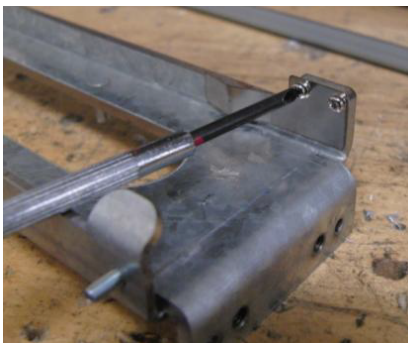

NOTE: If you are replacing only the Springs, skip the next two steps.

13. Remove Nuts (3) and the Chip Chute.



14. Remove the old Die Rail.



Installation Procedure

1. Place the new Die Rail Assembly in position.
2. Place the Chip Chute in position and tighten the Nuts (3).
3. Place the Springs (2) in position, install the M2 Lock Washers (4), and tighten the the M2 Screws (4).
4. Install all brackets from both sides.
5. Place the the Die Rail Assembly in position.
6. Install and tighten the Screws (4) that hold that Die Rail Assembly.

When installing (4) screws that hold the die rail, use 3mm reference holes for positioning the part. A 3mm pin can be inserted to hold the part in position while the screws are tightened.



7. Tighten the Screws (2) that hold the Dieset Recognition Bracket.
8. Connect the Alignment Sensor Board and place the wires in the Cable Clamps.
9. Connect the Back Gage Sensor Board and place the wires in the Cable Clamps.
10. Do REP 3.1 to install the Punch Module.
11. Do REP 1.6 to install the Rear Cover.
12. Install the Die Set (see Operator Manual).
13. Connect the Power Cord.
14. Power ON the entire printing system.

REP 3.16 Backgage Sensor Bracket Weldment and Backgage Sensor Lower Bracket Replacement

PARTS LIST ON PL 5.7

Use this procedure to remove and install the Backgage Sensor Bracket Weldment and Backgage Sensor Lower Bracket.

WARNING

Do not perform repair activities with the power on or electrical power supplied to the machine. Some machine components contain dangerous electrical voltages that can result in electrical shock and possible serious injury. See Section 0, page vi for other languages.

Removal Procedure

1. Switch power OFF to entire printing system.
2. Disconnect the Power Cord.
3. Do REP 1.6 to remove the Rear Cover.
4. Do REP 3.1 to remove the Punch Module.
5. Remove the M3 Nuts (2) that hold both the Brackets.

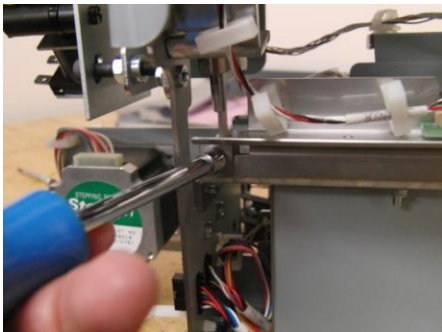

6. If replacing only the lower bracket, replace the Bracket then go to the installation procedure.
7. Unplug the Backgage Sensor and release the wires from the Cable Clamps.

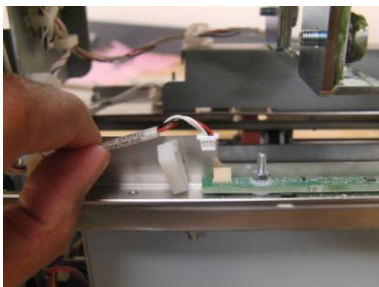

8. Transfer the Backgage Sensor and all fasteners to the new part.



Installation Procedure

1. Place the Brackets in position so the lower bracket overlaps the upper bracket.

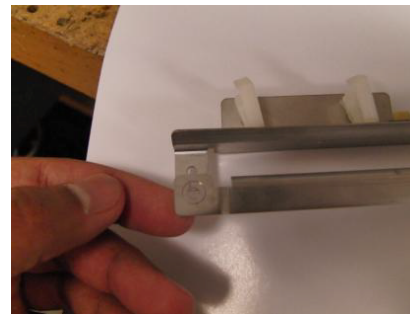

2. Connect the Backgage Sensor and place the wires in the Cable Clamps.
3. Tighten the M3 Nuts (2) that hold both the Brackets.
4. Do REP 3.1 to install the Punch Module.
5. Do REP 1.6 to install the Rear Cover.
6. Connect the Power Cord.
7. Power ON the entire printing system.

4. Power Supply

REP 4.1 24V Power Supply Replacement

PARTS LIST ON PL 3.5

Use this procedure to remove and install the 24V Power Supply Assembly.

Removal Procedure

WARNING

Do not perform repair activities with the power on or electrical power supplied to the machine. Some machine components contain dangerous electrical voltages that can result in electrical shock and possible serious injury. See Section 0, page vi for other languages.

1. Disconnect the Power Cord.
2. Do REP 1.6 to remove the Rear Cover.
3. Do GP 6.4 *Undock the Punch* to separate the Punch from the upstream and downstream devices.
4. Disconnect Connectors J1 and J3 from the Main Control Board.

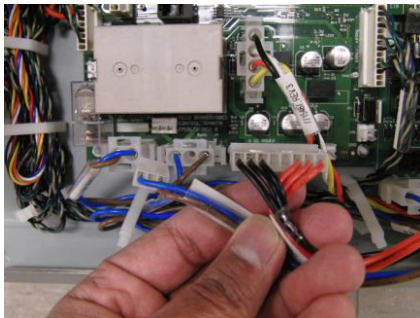

5. Remove the M4 Screw (1) and remove the Ground Cable from the Power Supply.

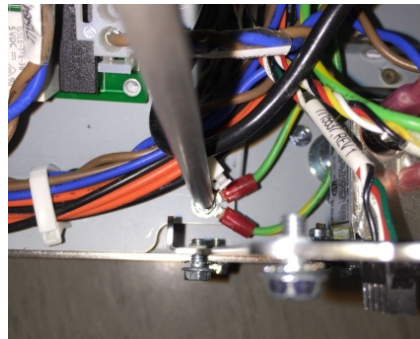

6. Release the cable clamps for the cables of J1, J3 and ground wire of Power supply all the way to grommet in the rear frame.



7. Remove the M4 Screws (4) from the side of the Base Frame.



8. Do REP 1.8 to remove the Upstream Side Frame Cover
Remove the Power supply through the opening as shown

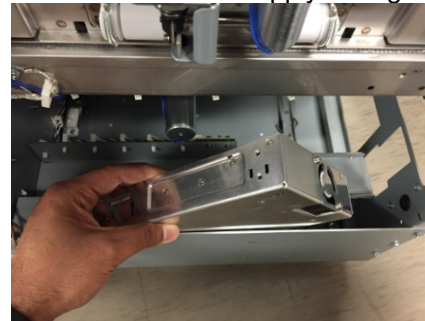

Installation Procedure

1. Reverse Steps for Installation.



9. Tilt the Power Supply and remove it through the Chip Tray opening. The die rack (loosened in the above step) has to bend up slightly to give room for the Power supply to be removed.

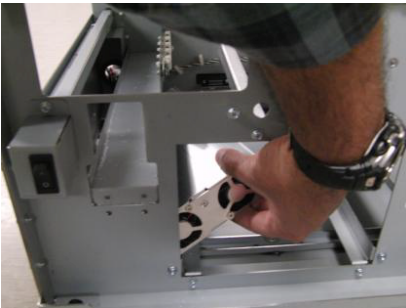

10. Transfer all wires to the new Power Supply.



REP 4.2 AC Filter Replacement

PARTS LIST ON PL 7.1

Use this procedure to remove and install the AC Filter Assembly.

Removal Procedure

WARNING

Do not perform repair activities with the power on or electrical power supplied to the machine. Some machine components contain dangerous electrical voltages that can result in electrical shock and possible serious injury. See Section 0, page vi for other languages.

1. Switch power OFF to entire printing system.
2. Disconnect the Power Cord.
3. Do REP 1.6 to remove the Rear Cover.
4. Remove the Phillips head Screws (2) and the AC Filter-USB Mount Bracket.

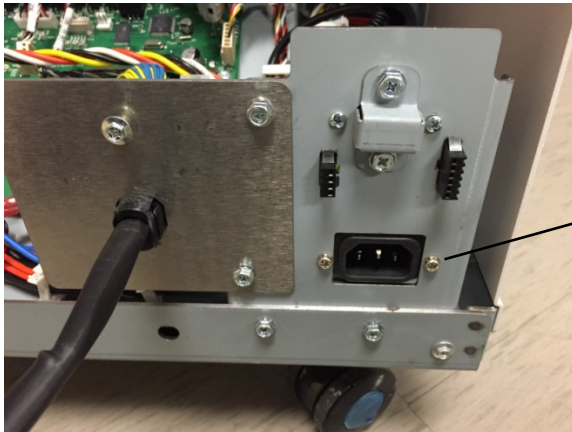

Screws (2)

5. Note the location of the wires (3).

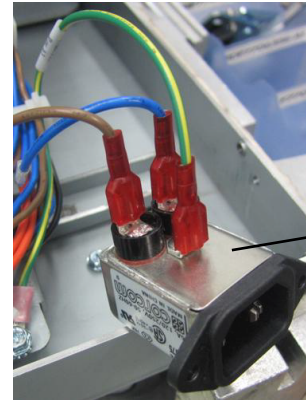

AC Filter

6. Remove the Wires (3) and the AC Filter.
7. Place the AC Filter in position and tighten the Screws (2).
8. Do REP 1.6 to install the Rear Cover.
9. Connect the Power Cord.
10. Power ON the entire printing system.

5. Electronics and Control

REP 5.1 Main Control Board Replacement

PARTS LIST ON PL 7.1

Use this procedure to remove and install the Main Control Board. Before replacing the Main Control board, attempt to retrieve the number of Punch cycles, do GP 6.1.11 Punch Cycles Procedure.

Removal Procedure

WARNING

Do not perform repair activities with the power on or electrical power supplied to the machine. Some machine components contain dangerous electrical voltages that can result in electrical shock and possible serious injury. See Section 0, page vi for other languages.

1. Switch power OFF to entire printing system.
2. Disconnect the Power Cord.
3. Do REP 1.6 to remove the Rear Cover.
4. Remove the M3 Screws (4) from the Main Control Board and the Comm Board.

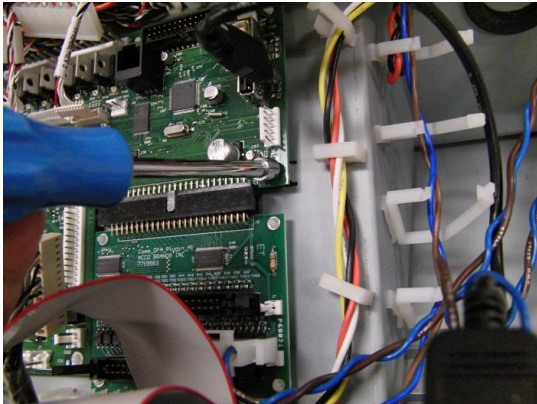

5. Use pliers to release the plastic Standoffs (9).

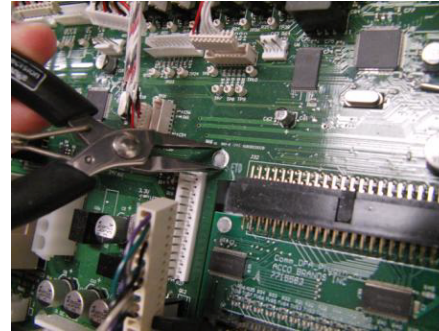

6. Disconnect the Connectors (24).
7. Remove the old Main Control Board and Comm Board.

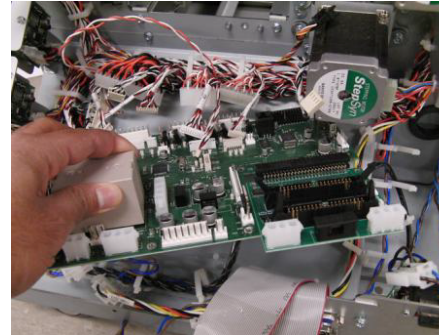

8. Disconnect the Connector and remove the Comm Board.

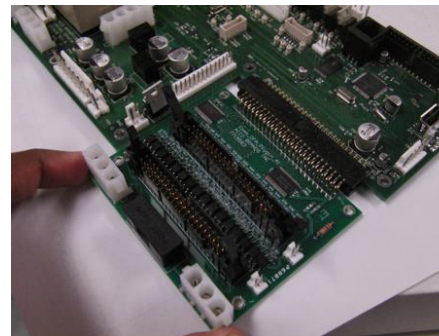

Installation Procedure

1. Install the the Comm Board on the Main Control Board and connect the Connector.
2. Place the new Main Control Board and Comm Board in position
3. Connect the Connectors (30),
Refer to the System Wiring diagram in Section 7.

The following table lists the connectors starting at the top right and going counterclockwise.

GBC Cable/Wire #	Connector #
7715523	J36
7715455	J23
7715467	J19
7715466	J18
7715536	J29
7715451	J21
7715485	J27
7715477	J17
7715462	J30
7715473	J15
7715453	J22
7715495	J9
7715468	J14
7715457	J25
7715456	J24
7715476	J2
7715493	J3
7715494	J4
7715487	J8
7715492	J1

Cable/Wire #	Connector #
7715459	J28
7715458	J26
7715267	J20
7715470	J16
7715538	J37
7715490	USB Connector
7715537	J12
7715548	J2 COMM Board
7715498	J14 COMM Board
7715494	J15 COMM Board

4. Use pliers to install the plastic Standoffs (9).
5. Tighten the M3 Screws (4) in the Main Control Board and the Comm Board.
6. Do REP 1.6 to install the Rear Cover.
7. Connect the Power Cord.
8. Power ON the entire printing system.

REP 5.2 Comm Board Replacement

PARTS LIST ON PL 7.1

Use this procedure to remove and install the Comm Board.

WARNING

Do not perform repair activities with the power on or electrical power supplied to the machine. Some machine components contain dangerous electrical voltages that can result in electrical shock and possible serious injury. See Section 0, page vi for other languages.

Removal Procedure

1. Switch power OFF to entire printing system.
2. Disconnect the Power Cord.
3. Do REP 1.6 to remove the Rear Cover.
4. Disconnect the Connectors (3).
 - Connector J2
 - Connector J14
 - Connector J15
5. Remove the Screws (3) and the old Comm Board.

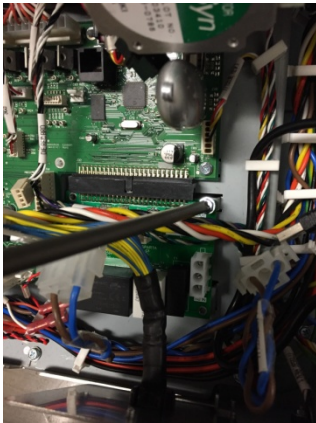

Installation Procedure

1. Place the new Comm Board in position and tighten the Screws (4).
2. Connect the Connectors (3).

Cable/Wire #	Connector #
7715548	J2 COMM Board
7715498	J14 COMM Board
7715494	J15 COMM Board

3. Do REP 1.6 to install the Rear Cover.
4. Connect the Power Cord.
5. Power ON the entire printing system.

REP 5.3 Dieset Recognition Reader Board Replacement

PARTS LIST ON PL 5.1 (page 2)

Use this procedure to remove and install the Dieset Recognition Reader Board

WARNING

Do not perform repair activities with the power on or electrical power supplied to the machine. Some machine components contain dangerous electrical voltages that can result in electrical shock and possible serious injury. See Section 0, page vi for other languages.

1. Switch power OFF to entire printing system.
2. Disconnect the Power Cord.
3. Do REP 1.6 to remove the Rear Cover.
4. Disconnect the Connector at the Dieset Recognition Reader Board.
5. Remove the M3 nuts (2) and the Dieset Recognition Reader Board.

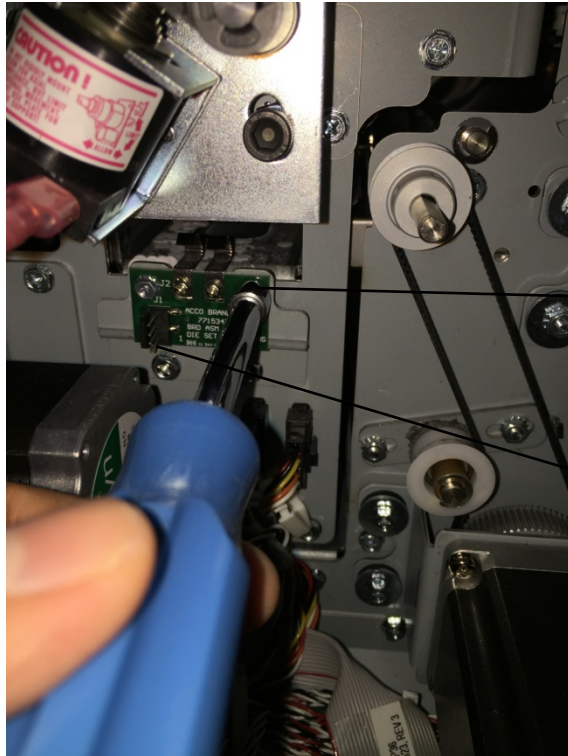

Screws (2)

Connector

Installation Procedure

1. Place the Dieset Recognition Reader Board in position and tighten the nuts (2).
2. Connect the Connector to the Dieset Recognition Reader Board.
3. Do ADJ 1.6 *Dieset Recognition Board Adjustment* to set the Dieset Recognition Reader Board.
4. Do REP 1.6 to install the Rear Cover.
5. Connect the Power Cord.
6. Power ON the entire printing system.

6. Adjustments

ADJ 1.1 Door Latch Adjustment

PARTS LIST ON PL 2.2

Do the following to ensure the door latch holds the door closed and that the activating bracket tab [1] depresses the door switch[2]. The tab should press the switch button just so that it is close to bottoming out.



WARNING

Do not perform repair activities with the power on or electrical power supplied to the machine. Some machine components contain dangerous electrical voltages that can result in electrical shock and possible serious injury. See Section 0, page vi for other languages.

1. Switch power OFF to entire printing system.
2. Disconnect the Power Cord.
3. Open the Front Door.

4. Loosen the Adjustment Screws (2) on the door latch.

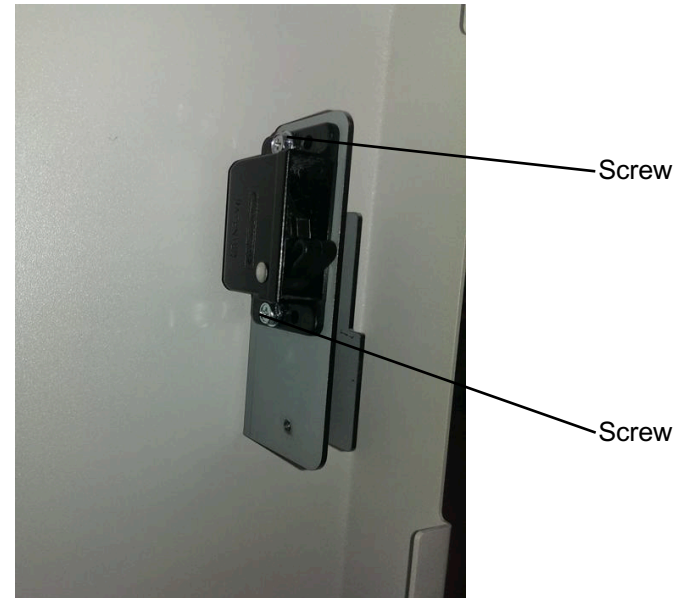

5. Do one of the following:
 - To move the door in, move the latch towards the front of the door.
 - To move the door out, move the latch away from the front of the door.
6. Tighten the Adjustment Screws (2).
7. Close the Front Door.
8. Connect the Power Cord.
9. Power ON the entire printing system.
10. Test the Door Latch operation.

ADJ 1.2 Diverter Solenoid Adjustment

PARTS LIST ON PL 3.3

Use this procedure to adjust the position of the Diverter Solenoid Assembly.

WARNING

Do not perform repair activities with the power on or electrical power supplied to the machine. Some machine components contain dangerous electrical voltages that can result in electrical shock and possible serious injury. See Section 0, page vi for other languages.

1. Open the Front Door.
2. Do REP 1.6 to remove the Rear Cover.
3. With the Interlock cheater inserted, do GP 6.2.5 to actuate SOL1 (L1-Diverter Solenoid). This will switch the diverter gate to punch mode. The Diverter gate will rise and hit the upper bypass panel.



4. When the solenoid is not actuated, it needs to rest on the Diverter limiter bracket. To properly adjust the position of the limiter bracket do the following:
 - a. Loosen the Screws (2) that hold the Limiter Bracket.

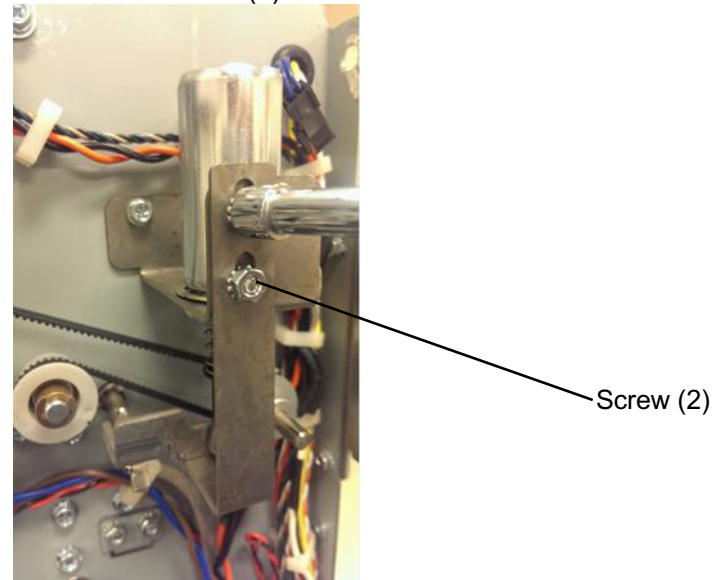

- b. Insert a 0.25 to 0.5mm shim between the Diverter and the Lower Entrance Panel.

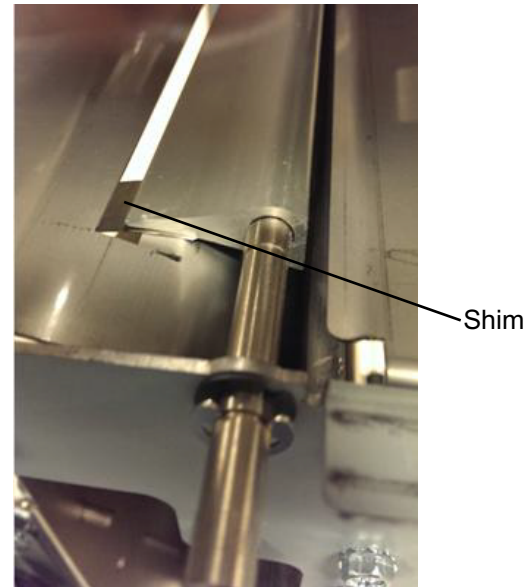

Raise the Limiter Bracket so that it just touches the Diverter Link and tighten the Screws (2).

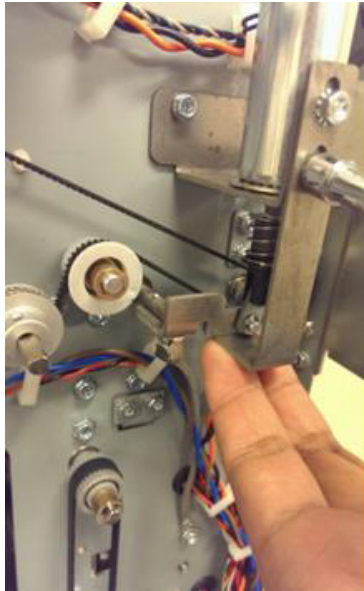

NOTE: Raising the Limiter Bracket too high will position the diverter gate higher, which will obstruct the paper flow and cause jams.

5. Check the clearance between the Diverter and the cutout in the Lower Entrance Panel at both sides.

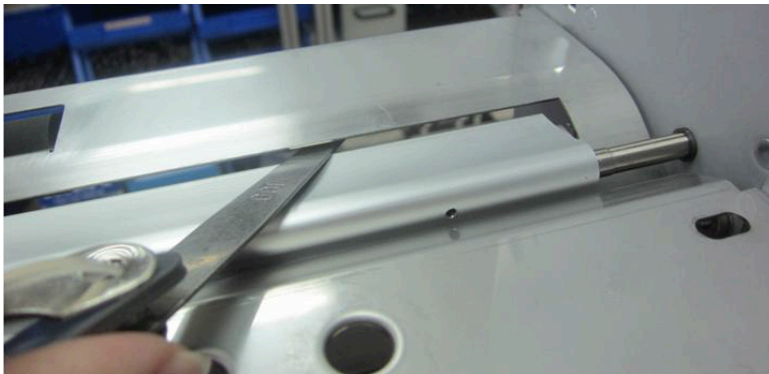

The clearance should be minimum 1.0 mm.

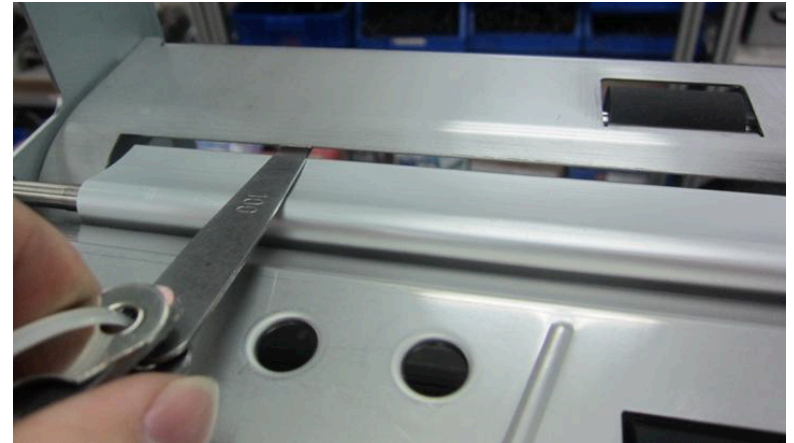

ADJ 1.3 Die Stop Magnet Adjustment

If the ALIGNMENT MODE Procedure (GP 6.1) does not move the inboard/outboard position of the punch holes far enough, use this procedure to adjust the Die Stop Magnet to move the holes inboard/outboard,

Note: The nominal position of the Die stop magnet face is 18.3mm from the face of the Punch module frame

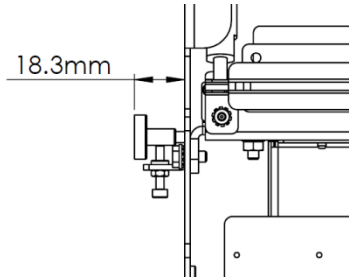

WARNING

Do not perform repair activities with the power on or electrical power supplied to the machine. Some machine components contain dangerous electrical voltages that can result in electrical shock and possible serious injury. See Section 0, page vi for other languages.

1. Open the Front Door.
2. Remove the Die Set (see Operator Manual).

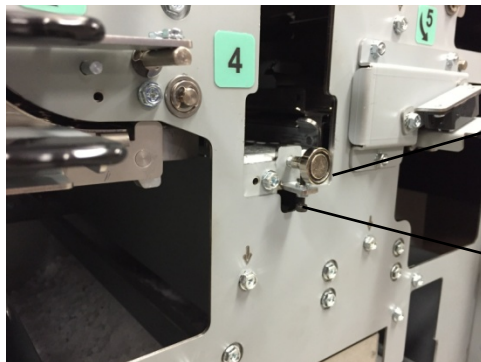

3. Loosen the Nut and Lock Screw.



4. Rotate the Die Set Magnet to adjust the position of the Die Set Stop.
 - Rotate the Die Set Magnet clockwise to move the hole toward the rear of the Punch.
 - Rotate the Die Set Magnet counterclockwise to move the hole toward the front of the Punch.



5. Tighten the Nut and Lock Screw.
6. Run some sheets of paper through the Punch Cycle.
7. Check the Alignment of the holes.
8. If necessary, repeat steps 3-6 until the alignment is centered (iterative process).
9. Install the Die Set (see Operator Manual).
10. Close the front Door.

ADJ 1.4 Timing Belts Adjustment

PARTS LIST ON PL 3.9

Use the below procedures for adjusting the tensions of timing belts.

WARNING

Do not perform repair activities with the power on or electrical power supplied to the machine. Some machine components contain dangerous electrical voltages that can result in electrical shock and possible serious injury. See Section 0, page vi for other languages.

ADJ 1.4.1 Alignment Stepper (M5) Belt Adjustment

PARTS LIST ON PL 5.3

Use this procedure to adjust the Alignment Stepper Belt tension.

1. Disconnect the Power Cord.
2. Do REP 1.6 to remove the Rear Cover.
3. Do REP 3.1 to remove the Punch Module.
4. Loosen the Phillips Screws (4).

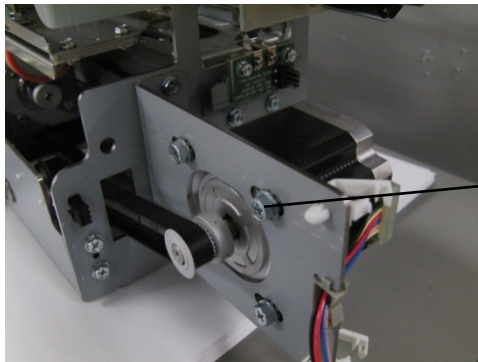

Screws (4)

5. Adjust the belt tension such that there is a deflection of 1~2mm.



6. Tighten the Phillips Screws (4).
7. Do REP 3.1 to install the Punch Module.
8. Do REP 1.6 to install the Rear Cover.
9. Connect the Power Cord.

ADJ 1.4.2 Bypass Motor- M8- belt adjustment (534T belt)

Use this procedure to adjust the Belt tension of 534T timing belt.

1. Disconnect the Power Cord.
2. Do REP 1.6 to remove the Rear Cover.
3. Loosen the the tensioner.

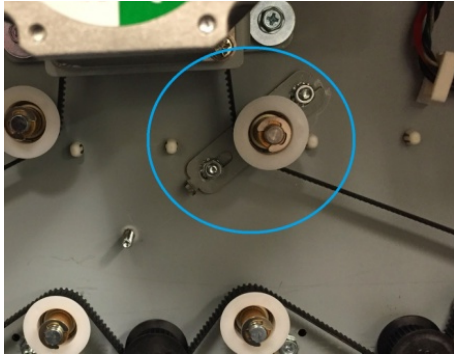

4. Adjust the belt tension such that there is a deflection of 6~8mm.

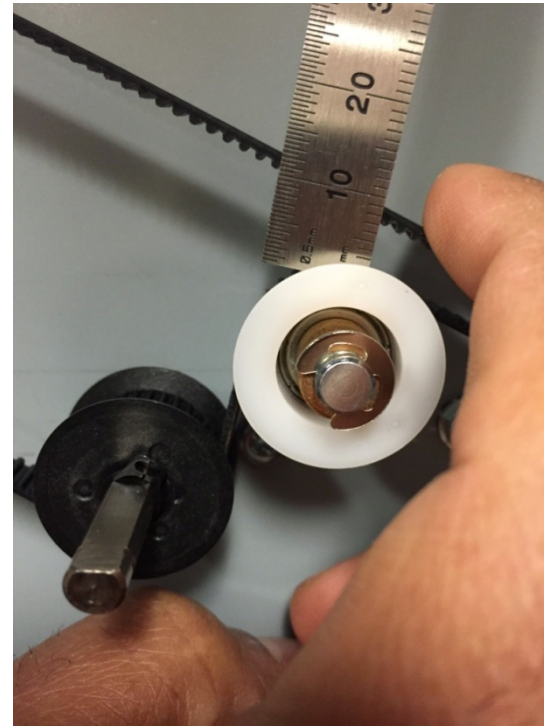

5. Tighten the tensioner
6. Do REP 1.6 to install the Rear Cover.
7. Connect the Power Cord.

ADJ 1.4.3 M1, M6, M7 Stepper belt adjustment (134T belt)

Use this procedure to adjust the Belt tension of 134T timing belt.

1. Disconnect the Power Cord.
2. Do REP 1.6 to remove the Rear Cover.
3. Loosen the the tensioner.



4. Adjust the belt tension such that there is a deflection of 3~5mm.

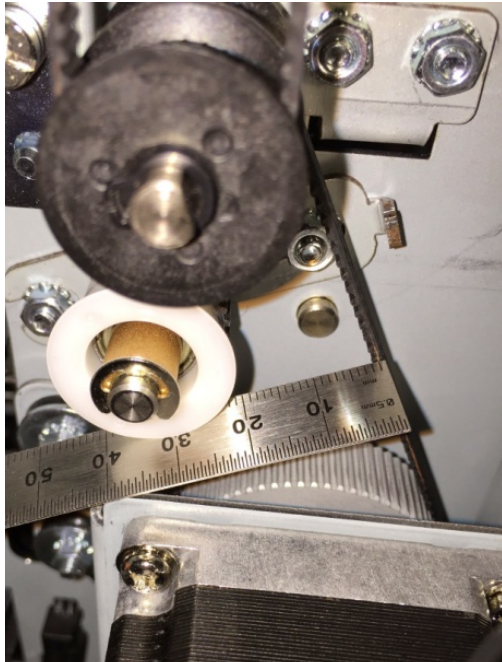

5. Tighten the tensioner
6. Do REP 1.6 to install the Rear Cover.
7. Connect the Power cord.

ADJ 1.4.4 M2 Stepper motor belt adjustment (179T belt)

Use this procedure to adjust the Belt tension of 134T timing belt.

1. Disconnect the Power Cord.
2. Do REP 1.6 to remove the Rear Cover.
3. Loosen the the tensioner.

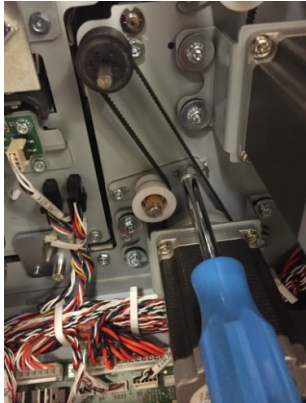

4. Adjust the belt tension such that there is a deflection of 4~6mm.



5. Tighten the tensioner
6. Do REP 1.6 to install the Rear Cover.
7. Connect the Power cord.

ADJ 1.4.5 Steering Motors- M3 and M4 belt adjustment

Use this procedure to adjust the Steering Sub-assembly Belt tension.

1. Disconnect the Power Cord.
2. Do REP 1.6 to remove the Rear Cover.
3. Do REP 3.1 to remove the Punch Module.
4. Loosen the Phillips Screws (4) from the Steering stepper motor.

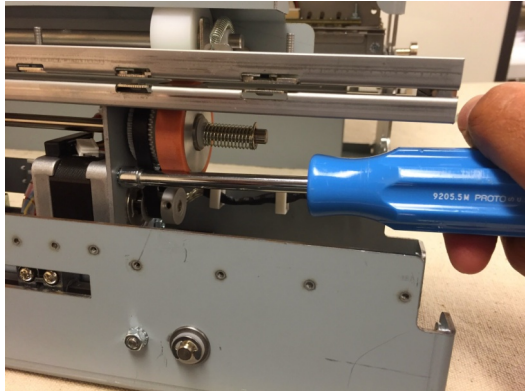

5. Adjust the belt tension such that there is a deflection of 1~2mm.

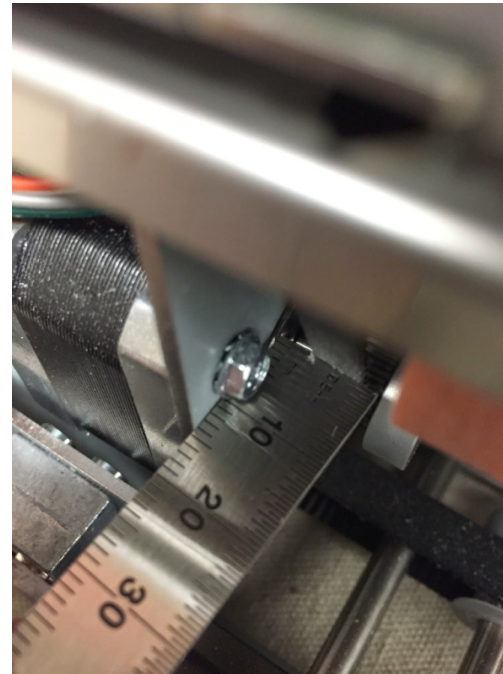
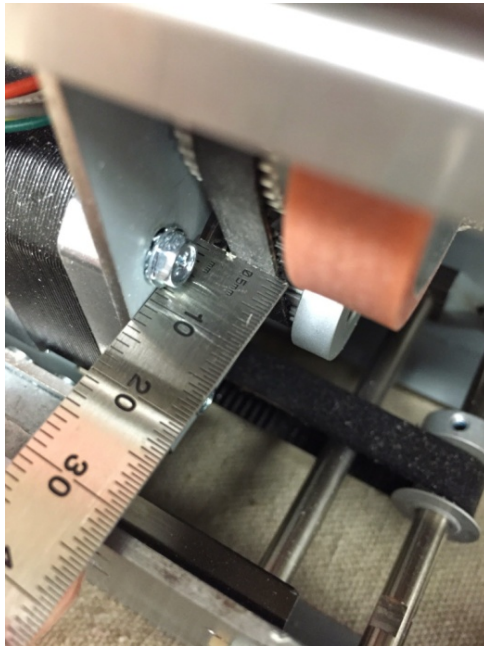

6. Tighten the Phillips Screws (4).
7. Do REP 3.1 to install the Punch Module.
8. Do REP 1.6 to install the Rear Cover.
9. Connect the Power Cord

ADJ 1.5 Punch Cam Indexing

PARTS LIST ON PL 5.6

Use this procedure to bring the punch cam to its home position after each punch cycle. The punch cam should reach its home position to ensure proper paper flow through the die set.

WARNING

Do not perform repair activities with the power on or electrical power supplied to the machine. Some machine components contain dangerous electrical voltages that can result in electrical shock and possible serious injury. See Section 0, page vi for other languages.

Note: Some designs in the images may be slightly different from those on the machine you are working on but this does not affect the setting procedure.

1. Verify that the punch cam needs to be indexed.

After a punch cycle the flats on the punch shaft have to be horizontal ($\pm 5^\circ$ from horizontal is acceptable). See below for an image of a properly indexed punch shaft.

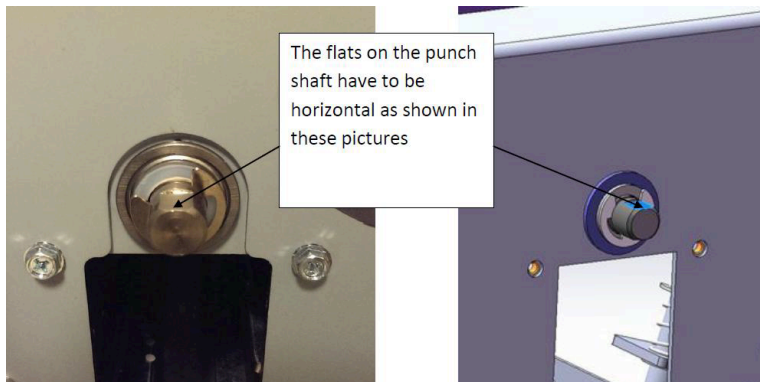

2. If the flats are not horizontal ($\pm 5^\circ$ from horizontal is acceptable), do the following procedure to set the shaft indexed position.

Important note: Punch Shaft/Cam rotates in the Clockwise direction when viewed from the front of the machine.



1. Switch power OFF to entire printing system.
2. Disconnect the Power Cord.
3. Do REP 1.6 to remove the Rear Cover.
4. Do REP 3.1 to remove the Punch Module.
(Cont.)

5. Inspect the punch cam position; the flat on the punch cam (or punch shaft) will indicate how far it has deviated from the horizontal position. In the example below the cam has rotated past the home position by 20°.



6. To index the shaft to the correct position, remove the spring clip from the its groove in the Punch clutch.

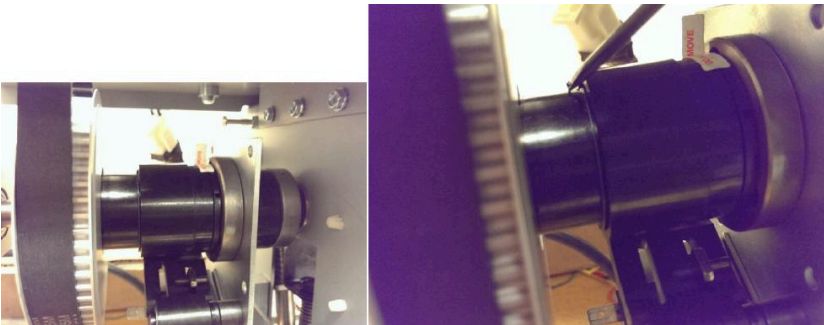

7. Continue to move the spring clip towards the pulley.

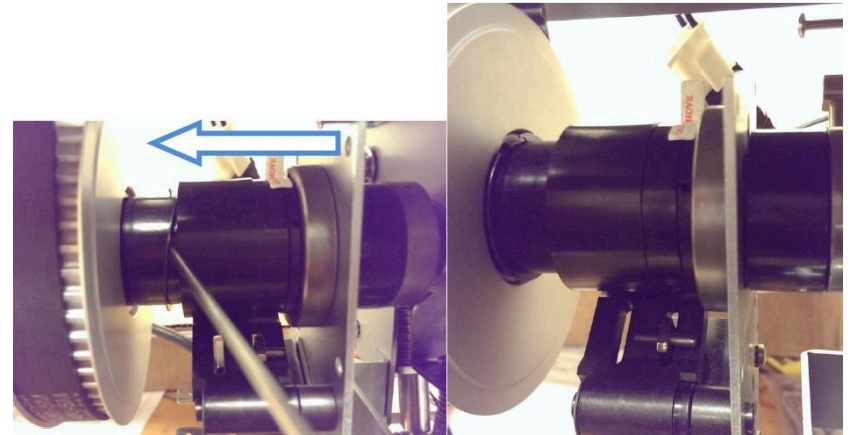

8. Move the control collar towards the pulley. By doing this the toothed hub will be exposed.

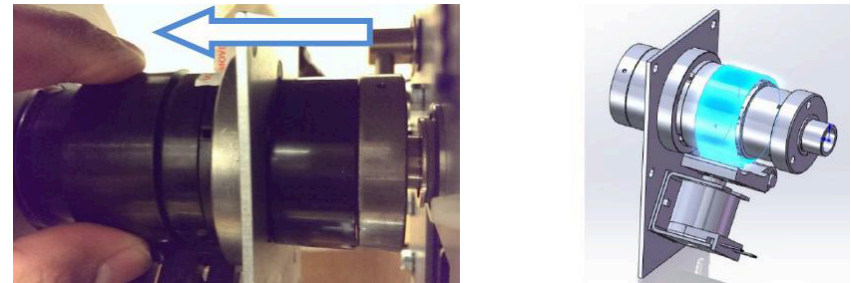

9. Rotate the Stop collar.

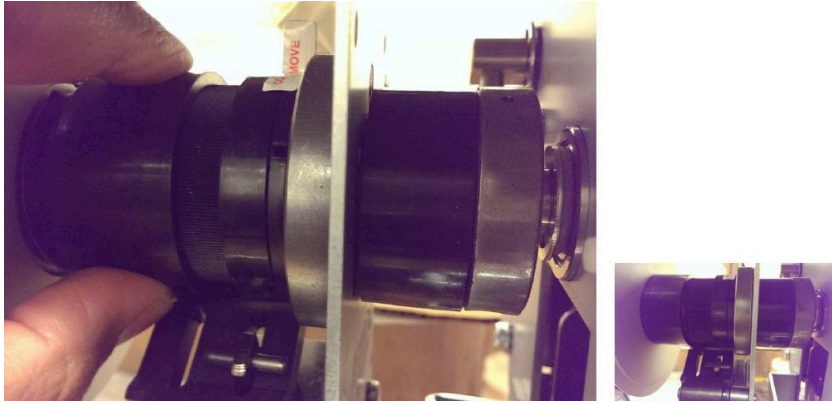

If the Punch Cam needs to stop earlier, rotate the Stop Collar Clockwise (when viewed from the rear of the machine).

If the Punch Cam needs to stop later, rotate the Stop Collar Counter-clockwise (when viewed from the rear side).

In this instance the cam needs to stop earlier, therefore rotate the Stop Collar Clockwise (when viewed from the rear side). This is done by manually lowering the pawl and freeing the Stop collar to rotate.

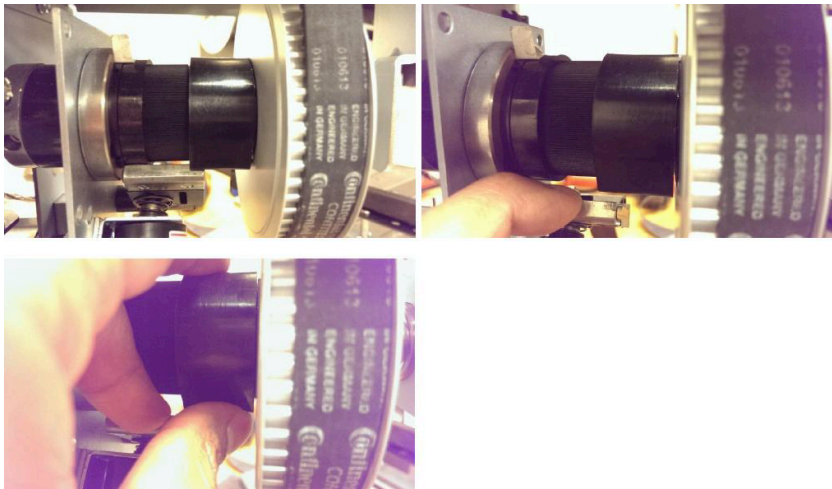

10. Release the Pawl and slide the Stop collar back to its position.

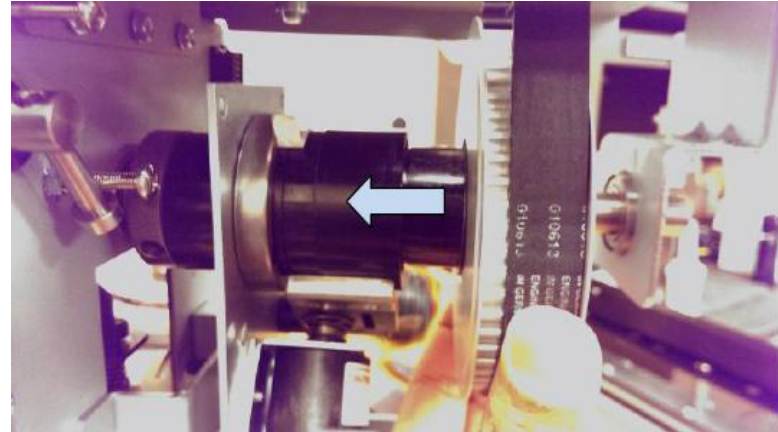

11. Manually rotate the pulley in the counter-clockwise direction (viewed from rear side) to complete a punch cycle.

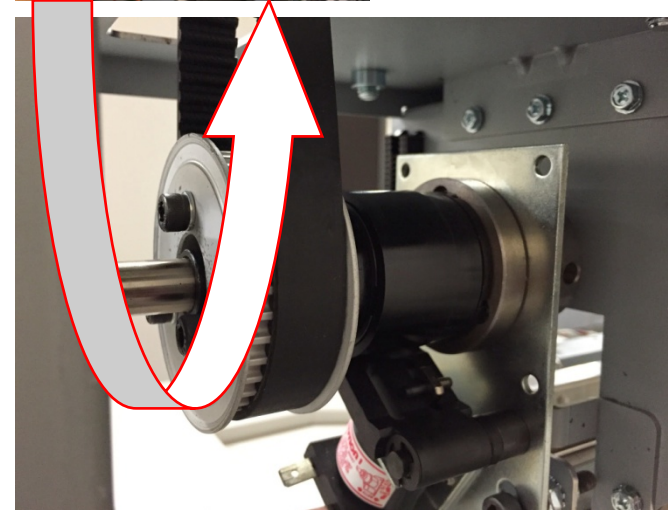
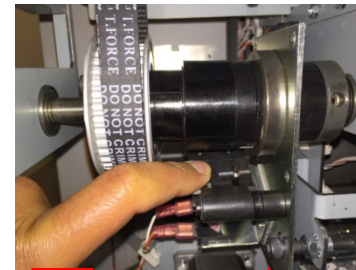

12. Repeat Steps 10 to 13 until the Punch shaft flats are horizontal. It is important to turn the punch shaft with a wrench until it hits a hard stop in the counter-clockwise direction (viewed from rear side). Important note: Turning the shaft with hand will not provide enough torque and the setting will be incorrect. Therefore use a wrench to turn the shaft.

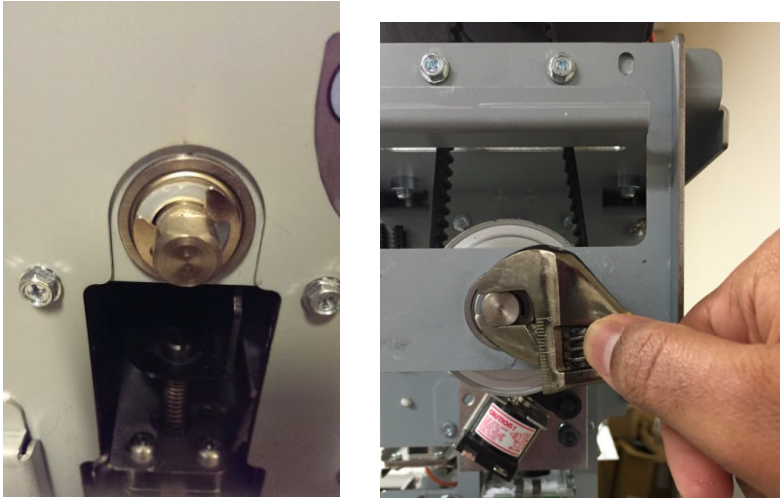

13. Return the spring clip to its groove.

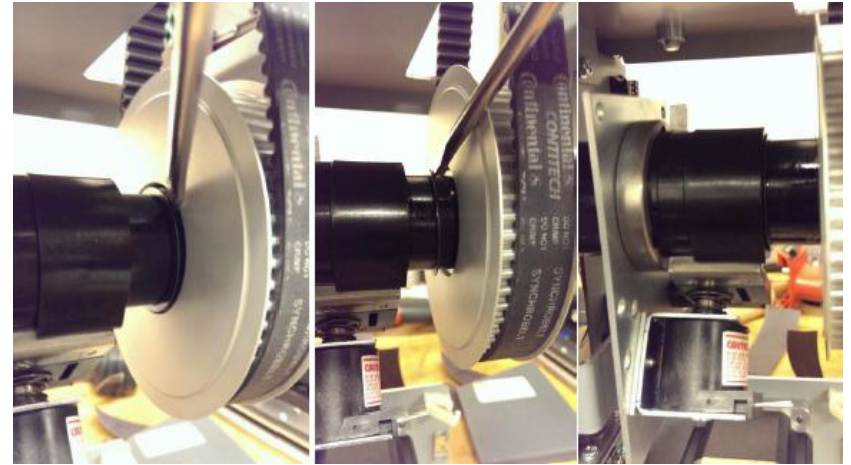

Installation Procedure

1. Do REP 3.1 to remove the Punch Module.
 2. Do REP 1.6 to install the Rear Cover.
 3. Connect the Power Cord.
 4. Power ON the entire printing system.
 5. Run one sheet of paper through the Punch.
- Alternately "Cycle Punch" Function Test from Service mode can be performed.
- After a punch cycle the flat in the front side would have returned to horizontal position (as shown in the pictures of Step# 1).

ADJ 1.6 Dieset Recognition Board Adjustment

PARTS LIST ON PL 5.1

Use this procedure to adjust the Dieset Recognition Board.

1. Do REP 1.6 to remove the Rear Cover.
2. Loosen the Screws (2) that hold the Dieset Recognition Reader Board.

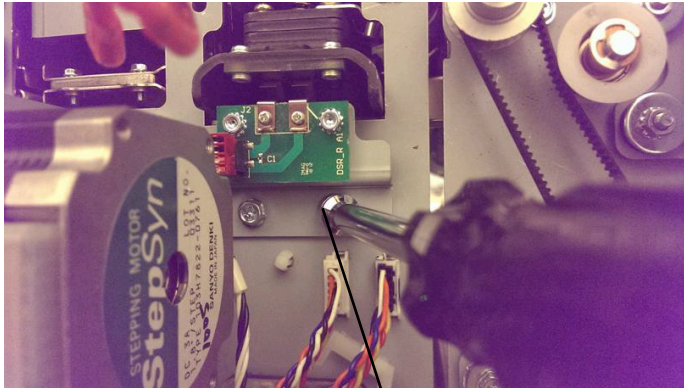

Screws (2)

3. Insert a die set until the Dieset is about to contact the spring clips in the Reader Board.

4. Raise/ Lower the bracket so that the top most point of the spring clips of Reader Board is approximately at the middle of the dieset recognition chip (1.5mm from the lower surface of the chip).

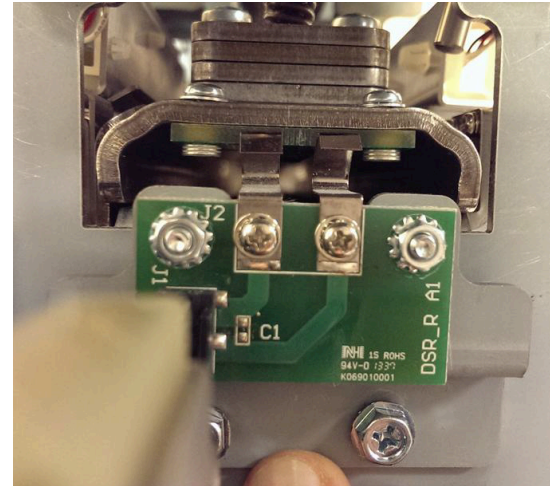

Note: Set the reader board so that there is 1.5 mm interference when the dieset is fully inserted. Excessive interference will lead to premature failure of the dieset recognition board and/or the spring clips. Insufficient contact may result in misread.

5. Tighten the Screws (2) that hold the Dieset Recognition Reader Board.
6. Do REP 1.6 to install the Rear Cover.

ADJ 1.7 Idler Panel Magnetic Latches Adjustment

Two round spacer studs should contact the drive panels completely (GP 6.16). When the Idler assembly is latched there should not be any movement in the assembly. If there is movement/play, do the below steps to adjust the assembly.

ADJ 1.7.1 Idler Panel Latches Adjustment procedure

This procedure applies to

- Entrance Idler Panel (PL 4.2)
 - Exit Idler Panel (PL 4.4)
 - Upper Bypass Panel (PL 4.5)
1. Loosen the two screws that hold the magnet. With the panel closed firmly, pull away the magnet away from the drive panel (to eliminate the play in the magnet) and tighten both screws. The screws should be tightened while the panel is closed firmly and the magnet pulled away as shown.

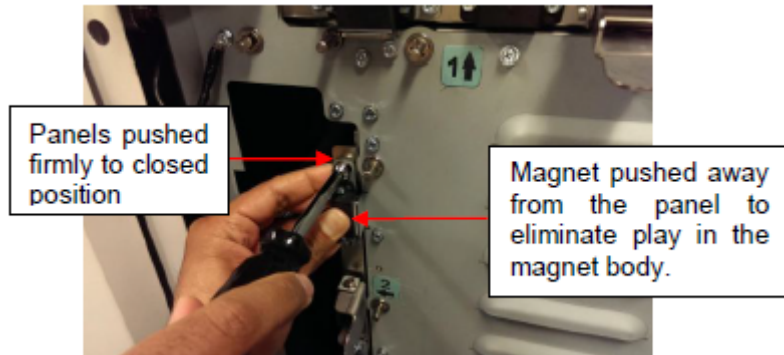

ADJ 1.7.2 Lower Exit panel latch Adjustment procedure

This procedure applies to

- Lower Exit Panel Assembly (PL 3.1)
1. Loosen the two screws that hold the magnet. With the panel fully closed (the panel will hit limiting tabs and you will hear a sound), tighten the two screws.

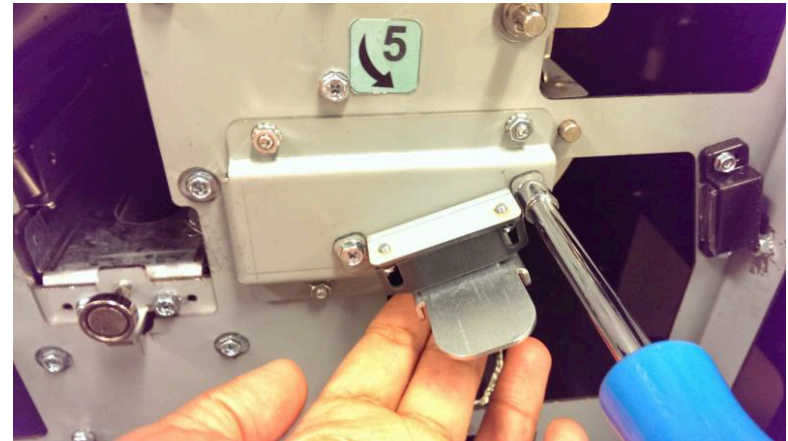

ADJ 1.8 Drive Panel Position Adjustment

PARTS LIST ON PL 3.1

Use this procedure to inspect and adjust the Drive panel positions. The drive panels control how far the drive rollers protrude into the paper path, which in turn control the roller nip forces. All drive rollers should be protruding 1.5 ± 0.5 mm through the paper path.

This procedure applies to

- Entrance Drive Panel (PL 3.1)
- Exit Drive Panel (PL 3.1)
- Lower Bypass Panel (PL 3.1)

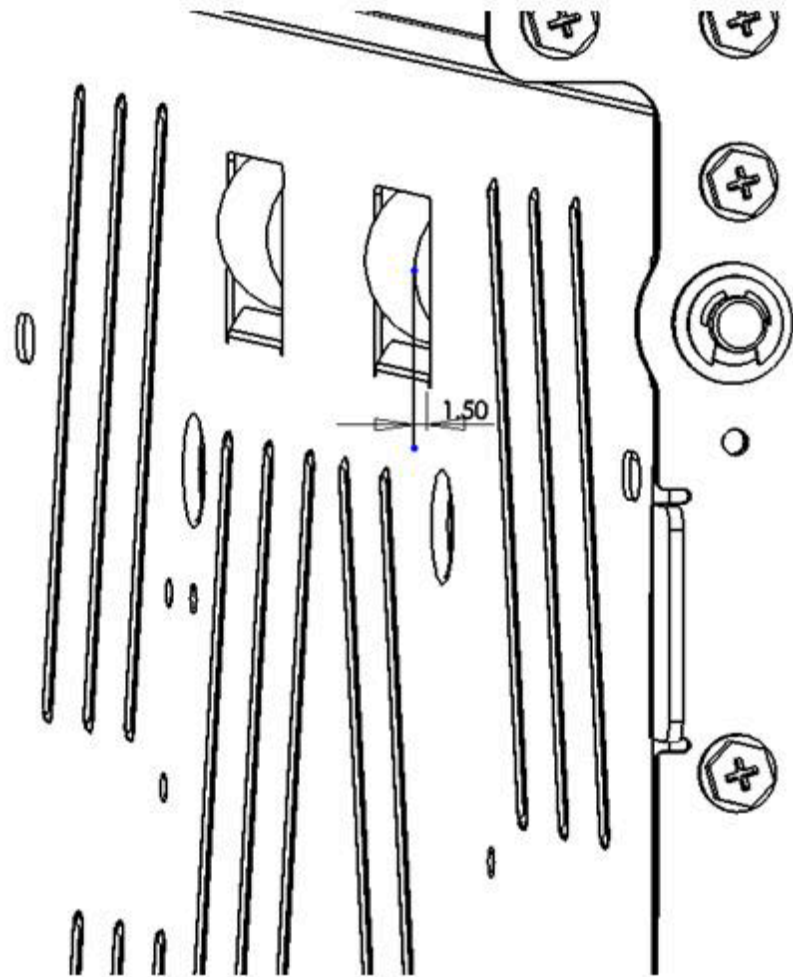

ADJ 1.8.1 Entrance Drive Panel Position Adjustment

This drive panel controls the nip forces of N2, N3, N4 and N5.

1. To adjust the position of the drive panel loosen (5) screws from the Front frame and (5) screws from the rear frame.

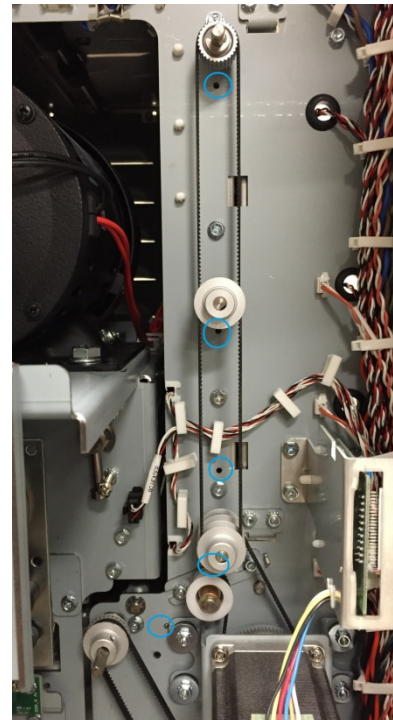
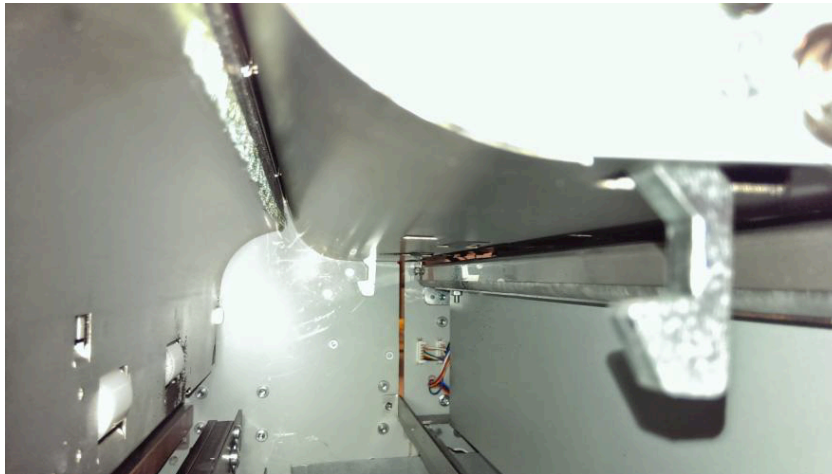
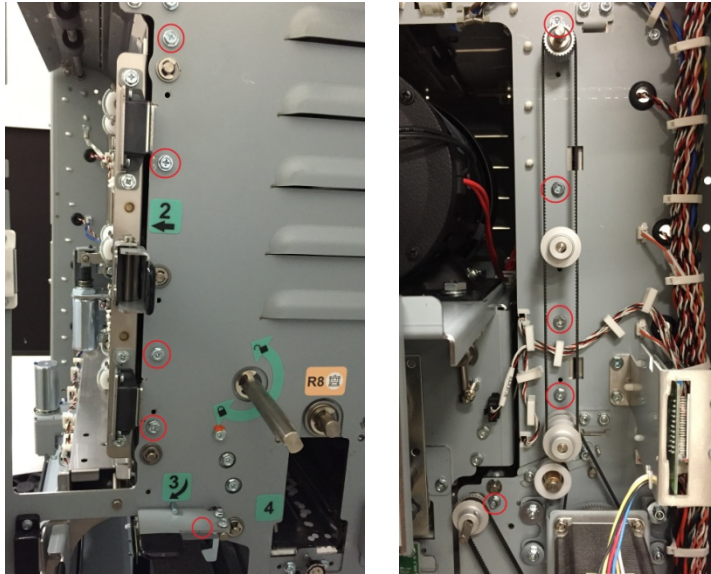

2. Using the Reference holes in the front/rear frame (5 holes in the front frame and 5 holes in the rear frame) and the sheet metal panel, position the drive panel to ensure the drive rollers protrude 1.5 ± 0.5 mm through the drive panel.

ADJ 1.8.2 Exit Drive Panel Position Adjustment

This drive panel controls the nip forces of N8, N9 and N10.

1. To adjust the position of the drive panel loosen (4) screws from the Front frame and (4) screws from the rear frame

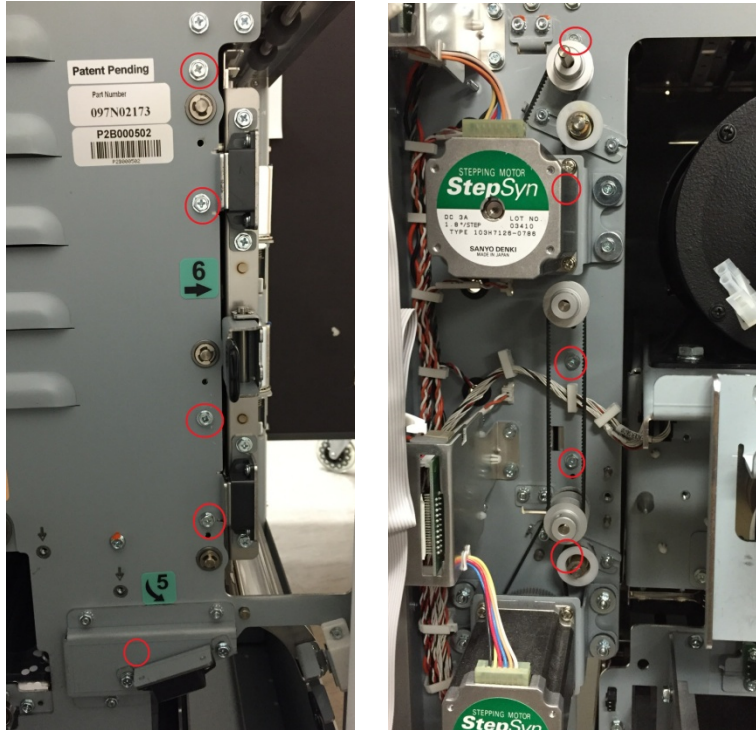

2. Using the Reference holes in the front/rear frame (4 holes in the front frame and 4 holes in the rear frame) and the sheet metal panel, position the drive panel to ensure the drive rollers protrude 1.5 ± 0.5 mm through the drive panel.

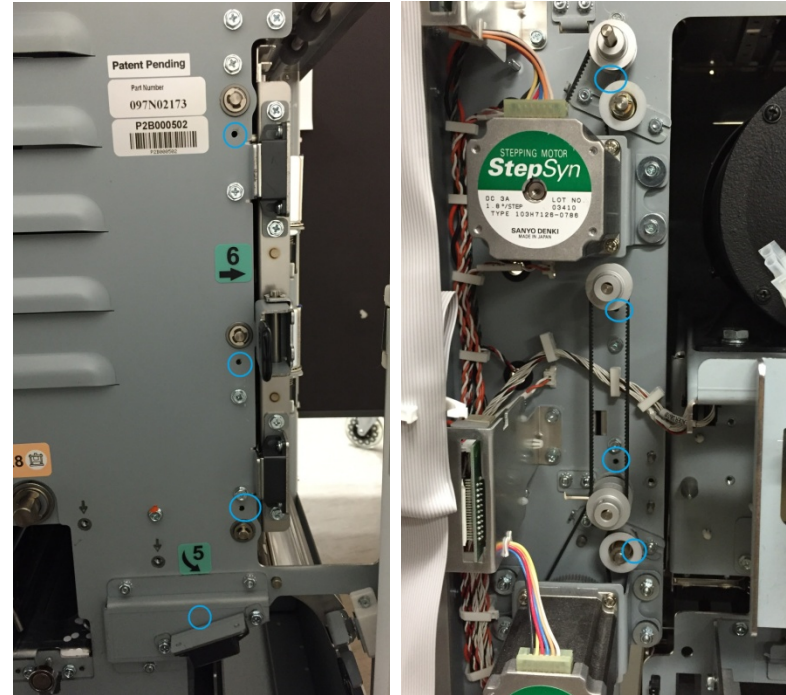

ADJ 1.8.3 Lower Bypass Panel Position Adjustment

This drive panel controls the nip forces of N12, N13 and N14.

1. To adjust the position of the drive panel loosen (4) screws from the Front frame and (4) screws from the rear frame.

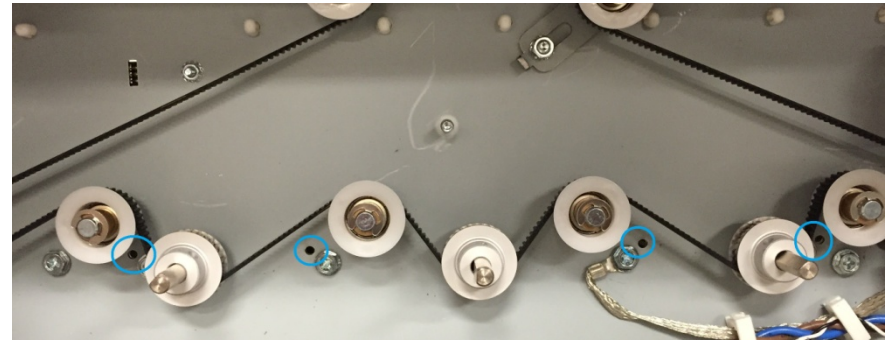
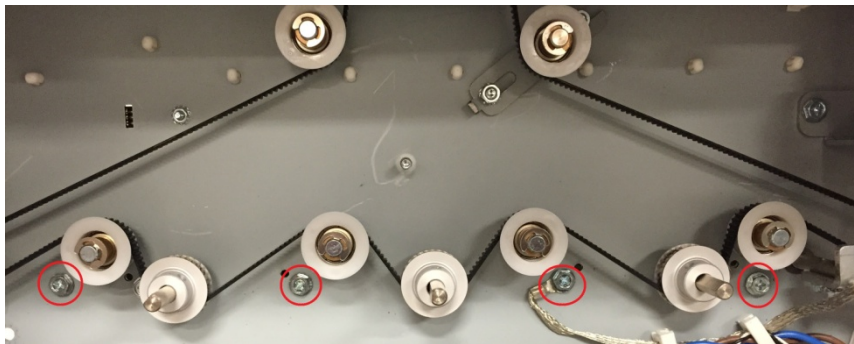
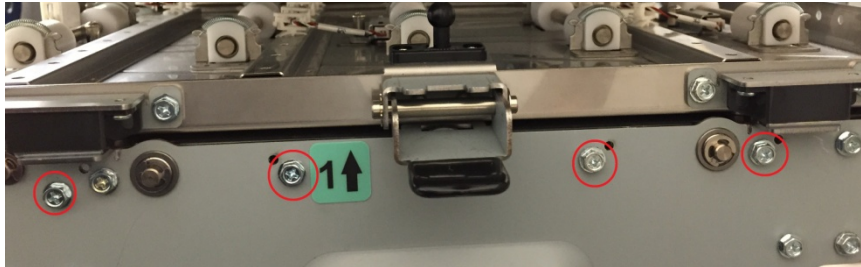

2. Using the Reference holes in the front/rear frame (4 holes in the front frame and 4 holes in the rear frame) and the sheet metal panel, position the drive panel to ensure the drive rollers protrude 1.5 ± 0.5 mm through the drive panel.



Notes:

5. Parts List (PL)

Section Contents

- 1. Introduction 2**
- 2. Main Assembly 3**
 - PL 2.1. Final Assembly 3
 - PL 2.2. Cabinet – Covers 4
- 3. Frame Assembly 5**
 - PL 3.1. Frame Assembly- Paper path panels 5
 - PL 3.2. Frame Assembly- Front side 6
 - PL 3.3. Frame Assembly- Rear Side 7
 - PL 3.4. Frame Assembly- Drive Rollers..... 8
 - PL 3.5. Frame Assembly- Internal Parts 9
 - PL 3.6. Frame Assembly- Motors and Motor Drivers 10
 - PL 3.7. Frame Assembly- Sensors 11
 - PL 3.8. Frame Assembly- Solenoids / Switches 12
 - PL 3.9. Frame Assembly- Belts and Pulleys 13
- 4. Paper Path 14**
 - PL 4.1. Paper Path- Entrance Drive Panel .. 14
 - PL 4.2. Paper Path- Entrance Idler Panel.... 15
 - PL 4.3. Paper Path- Acceleration Roller Idler16
 - PL 4.4. Paper Path- Exit Idler Panel 17
 - PL 4.5. Paper Path- Upper Bypass Panel ... 18
 - PL 4.6. Paper Path- Disengaging Roller Solenoid 19
- 5. Punch Module 20**
 - PL 5.1. Punch Module..... 20
 - PL 5.1. Punch Module (continued)..... 21
 - PL 5.2. Punch Module- Motors/Sensors 22
 - PL 5.3. Punch Module- Steering Module 23
 - PL 5.4. Punch Module- Steering Module - Steering Idler Panel Sub Assembly 24
 - PL 5.5. Punch Module- Steering Module - Drive Panel Steering 25
 - PL 5.6. Punch Module- Punch Clutch..... 26
 - PL 5.7. 26
 - PL 5.8. Punch Module- Die Rail, Backgage, Align Sensors, Sub Assembly 27
 - PL 5.9. Punch Module- AC Motor 28

- Die Sets29**
- 6. Electronics30**
 - PL 6.1. Electronics PCB Assembly30
 - PL 6.2. Control Board Bracket Sub Assembly30
 - PL 6.3. Cable Part Number Index32
 - PL 6.4. Wiring Drawing- OEM Configurations33
- 7. Installation Kit Parts34**
- 8. Hardware Kits34**
- 9. Optional Kits34**

Introduction

Overview

The Parts List section identifies all part numbers and the corresponding location of all spared subsystem components.

Organization

Each item number in the part number listing corresponds to an item number in the related illustration.

All the parts in a given subsystem of the machine will be located in the same illustration or in a series of associated illustrations.

For electrical parts, the description also contains the component number.

Tag Matrix

The notation “W/Tag” in the parts description indicates that the part configuration has been updated. Check the Change Tag Index in Section 6, *General Procedures and Information* for the name and purpose of the modification.

In some cases, a part or assembly may be spared in two versions: with the Tag and without the Tag. In those cases, use whichever part is appropriate for the configuration of the machine on which the part is to be installed. If the machine does not have a particular Tag and the only replacement part available is listed as “W/Tag”, install the Tag kit or all of the piece parts. The Change Tag Index tells you which kit or piece parts you need.

Whenever you install a Tag kit or all the piece parts that make up a Tag, mark the appropriate number on the Tag matrix.

The Tag matrix is located inside the Front Right Door (PL 2.2).

Symbology

Tag



Description

A Tag number within a circle pointing to an item number shows that the part has been changed by the tag number within the circle. Information on the modification is in the Change Tag Index.



A Tag number within a circle having a shaded bar and pointing to an item number shows that the configuration of the part shown is the configuration before the part was changed by the Tag number within the circle.



A tag number within a circle with no apex shows that the entire drawing has been changed by the tag number within the circle. Information on the modification is in the Change Tag Index.



A tag number within a circle with no apex and having a shaded bar shows that the entire drawing was the configuration before being changed by the tag number within the circle.

027N00262^B

A Part number with a super script A, B, C, D, E or F is contained in a Hardware kit. The corresponding Hardware kit part number is listed below each List.

24 *DFA*

A part number with a suffix DFA and italicized text indicated that it is unique to DFA configurations.

Main Assembly

PL 2.1. Final Assembly

ITEM	GBC Part #	FujifilmPart #	DESCRIPTION
1	WSM7724210	ED201658	FUTUROPUNCH PRO, 230V

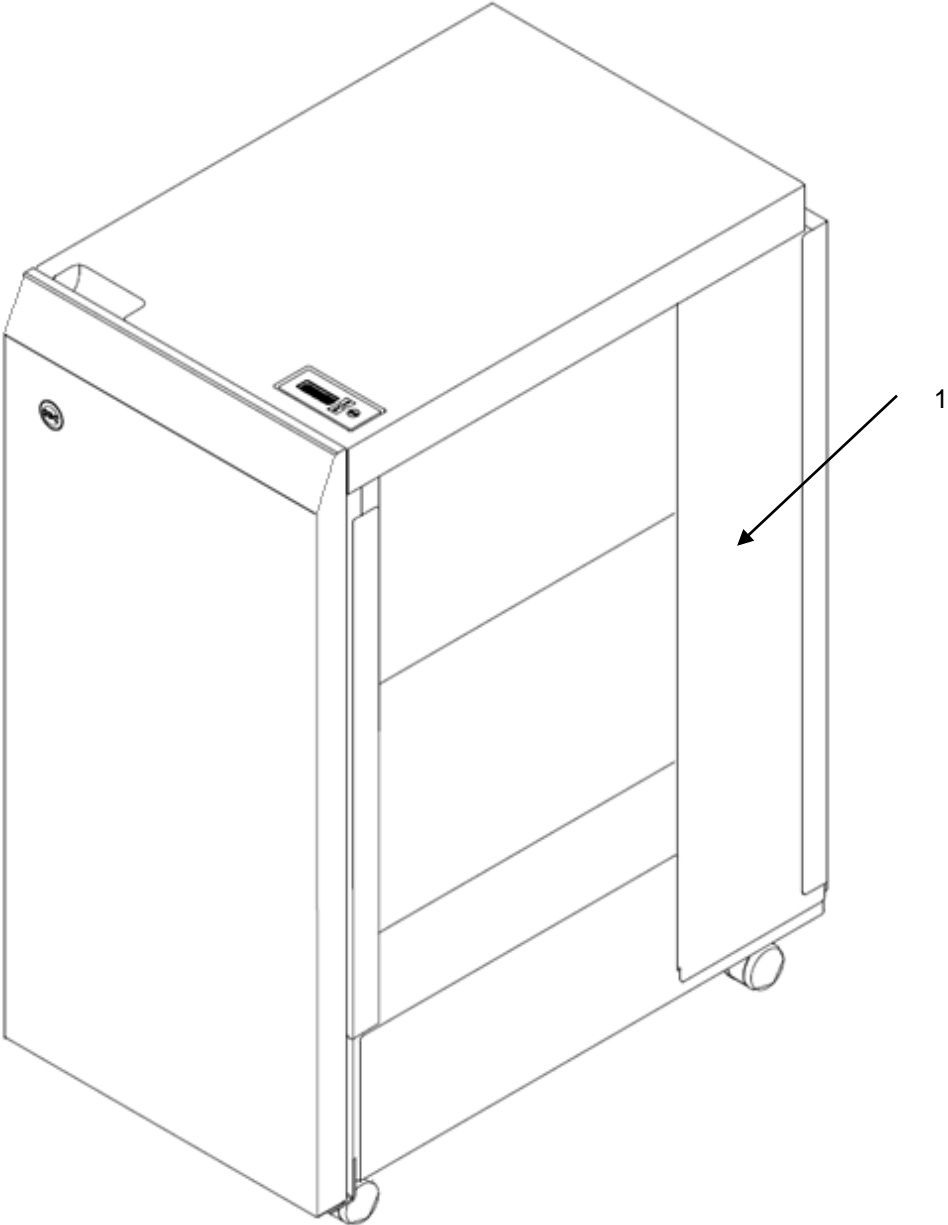

PL 2.2. Cabinet – Covers

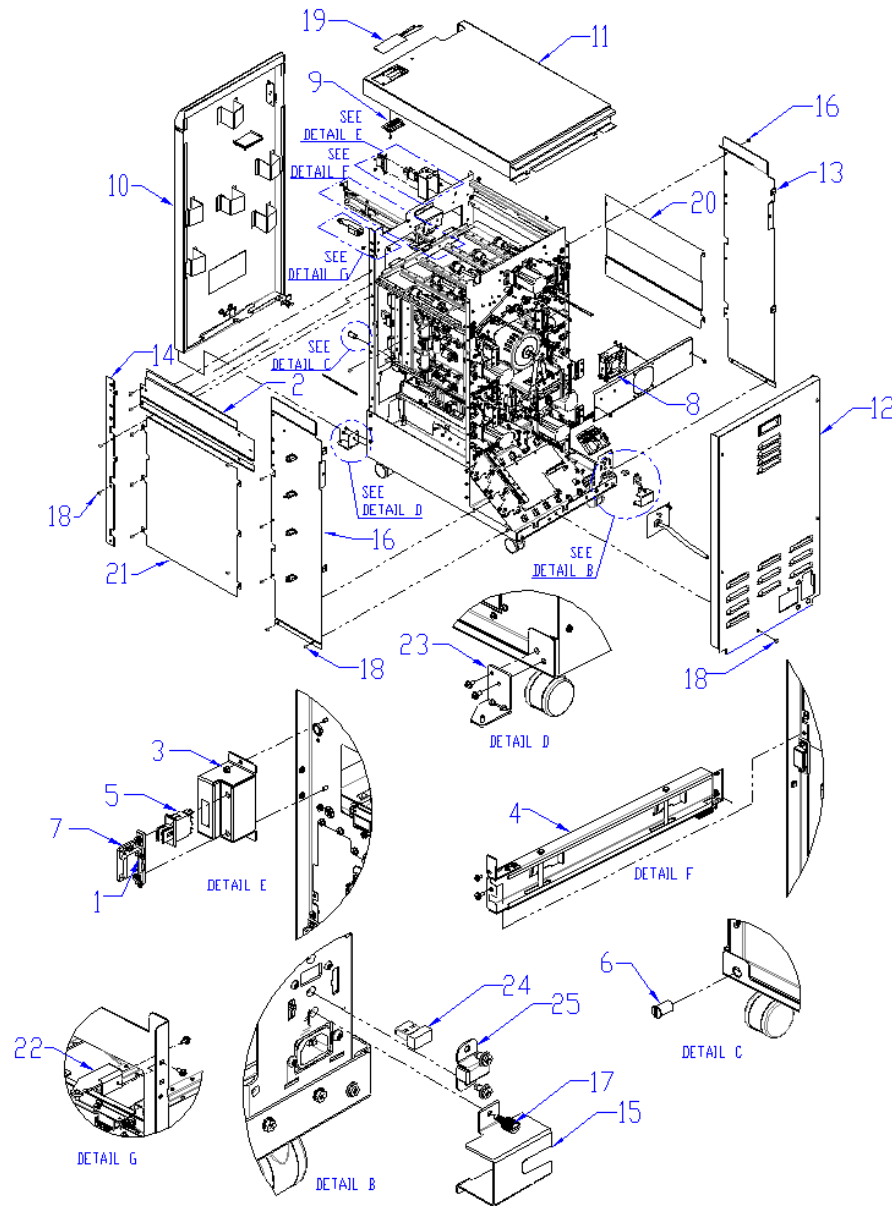

ITEM	GBC Part #	DESCRIPTION	QTY
1	1823901 ^B	SCREW,PHILLIPS W/SEMS,M3X6	2
2	7715838	COVER, SIDE FRAME, DOWNSTREAM, UPPER	1
3	1824001 ^B	NUT, KEPS M4	2
4	7715565	DOCKING BRACKET	1
5	7610501	INTERLOCK SWITCH	1
6	7706447	MAGNET, FRONT DOOR	1
7	7706486	LATCH, PUSH TO CLOSE	1
8	7715267	EXHAUST FAN	1
9	7715527	LCD, DISPLAY	1
10	7724966	FRONT DOOR ASSEMBLY	1
11	7724979	TOP COVER ASSEMBLY	1
12	7724978	REAR COVER ASSEMBLY	1
13	7724972	UPSTREAM REAR SIDE COVER	1
14	7724975	COVER,SIDE,DOWNSTREAM, FRONT	1
15	7718685	COVER, POWER CORD	1
16	7724973	DOWNSTREAM REAR SIDE CVR	1
17	7715844	CAPTIVE SCREW, M4X0.7, 5MM	1
18	7715632 ^B	SCREW, ROUND TIP, M4 X 8	22
19	7715682	PANEL, LCD MEMBRANE	1
20	7715686	COVER,SIDE FRAME,UPSTREAM	1
21	7715687	COVER, SIDE FRAME, DOWNSTREAM, LOWER	1
22	7715569	FRONT DOOR TOP HINGE	1
22 DFA	7715782	FRONT DOOR TOP HINGE	1
23	7715570	FRONT DOOR BOTTOM HINGE	1
23 DFA	7715783	FRONT DOOR BOTTOM HINGE	1
24	7715684	DRIVE,USB STICK, FLASH DRIVE	1
25	7715828	USB DRIVE COVER	1
B	7715974	KIT, HARDWARE, FASTENERS	

Frame Assembly

PL 3.1. Frame Assembly- Paper path panels

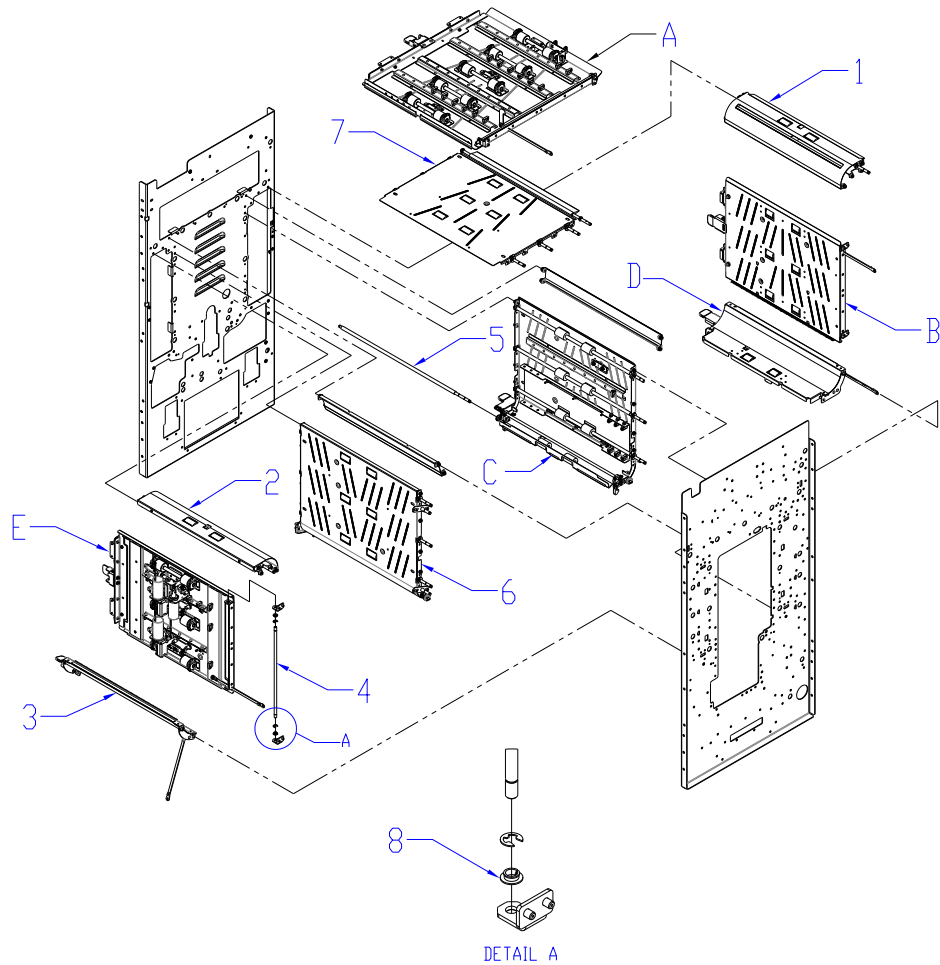

ITEM	GBC Part #	DESCRIPTION	QTY
A	PL 4.5	UPPER BYPASS PANEL	1
B	PL 4.2	ENTRANCE IDLER PANEL	1
C	PL 4.1	ENTRANCE DRIVE PANEL	1
D	PL 4.3	ACCELERATION IDLER PANEL	1
E	PL 4.4	EXIT IDLER PANEL	1
1	7715101	PANEL, ENTRANCE, LOWER	1
2	7715690	PANEL, EXIT, LOWER	1
3	7715424	PANEL ASSEMBLY, LOWER, EXIT	1
4	7715209	SHAFT, IDLER PANEL HINGE	2
5	7715210	SHAFT, IDLR PANEL HINGE, LONG	3
6	7715150	PANEL WELDMNT, DRIVE, EXIT	1
7	7715128	PANEL WELDMNT, BYPASS, LOWER	1
8	1821209 ^D	SNAP-IN BEARING, 6MM ID [QTY. (2) USED ON ALL IDLER PANELS- #A, #B, #D, #E AND #3	10
D	7715976	KIT, HARDWARE, BEARINGS	

PL 3.2. Frame Assembly- Front side

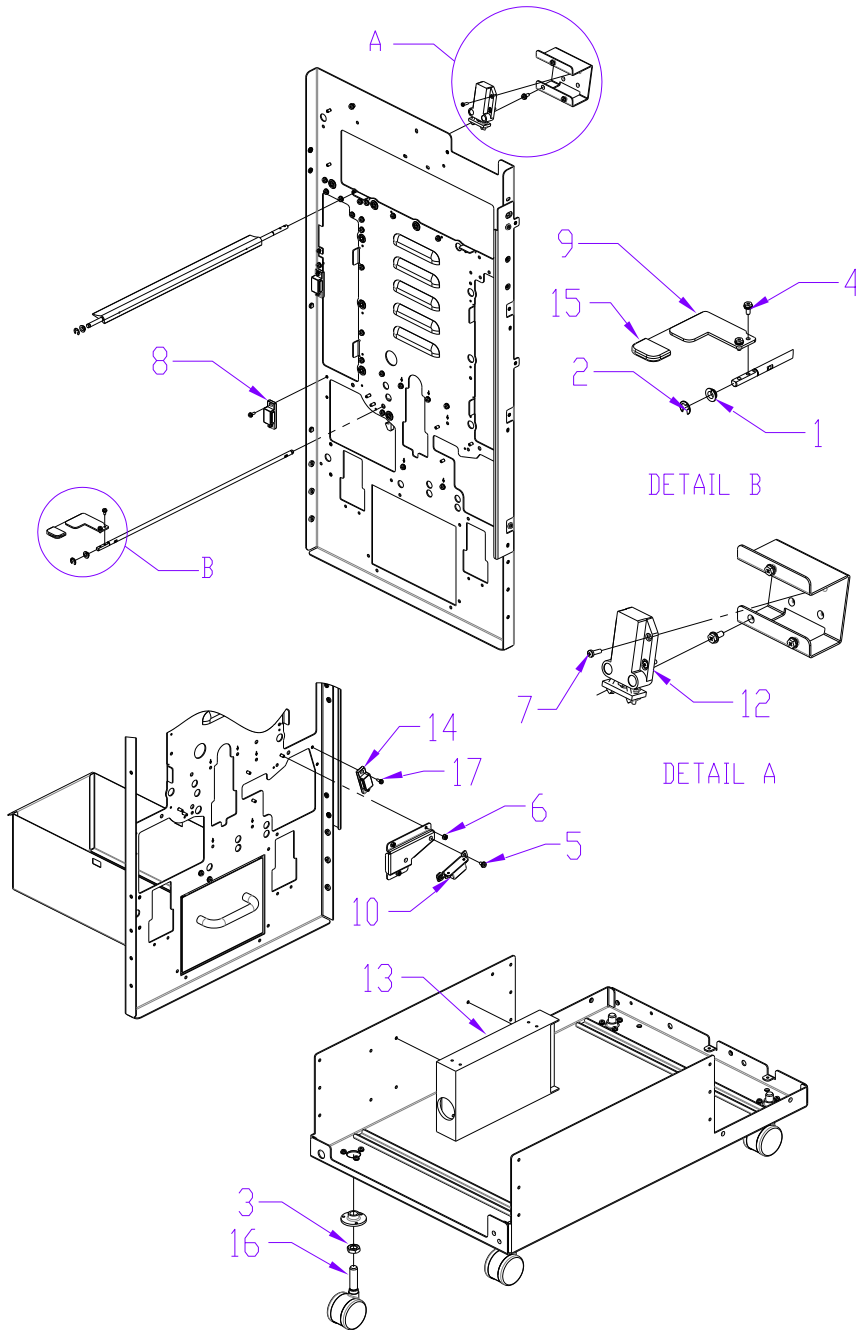

ITEM	GBC Part #	DESCRIPTION	QTY
1	1821209 ^D	SNAP-IN BEARING, 6MM ID	2
2	1822202 ^A	E-RING, JE-5	4
3	1823711 ^B	JAM NUT, M16X2.0	4
4	1823901 ^B	SCREW, HX, W/SEMS,M3X6	2
5	1823909 ^B	SCREW, HX, W/SEMS M4X6	2
6	1824001 ^B	NUT, KEPS M4	3
7	1821606 ^B	SCREW, PHILLIPS PAN HD, M3X10	6
8	7715195	MAGNET, PANEL, OPEN, STRONG	1
9	7715215	HANDLE, ACCEL IDLER LATCH	1
10	7715385	MAGNET, BRACKET, ASSY	1
11	7715427	CHIP TRAY, ASSEMBLY	1
12	7715650	LATCH, BYPASS	1
13	7715637	POWER SUPPLY, 24V, MW SP 480,	1
14	7715789	MAGNET, PANEL, OPEN, WEAK	3
15	7708163	CAP, RUBBER, RAIN BLUE	2
16	7715630	CASTER, ADJUSTABLE	4
17	1823913 ^B	SCREW, HX, W/SEMS, M3 X 8	8
A	7715973	KIT, HARDWARE, RINGS	
B	7715974	KIT, HARDWARE, FASTENERS	
D	7715976	KIT, HARDWARE, BEARINGS	

PL 3.3. Frame Assembly- Rear Side

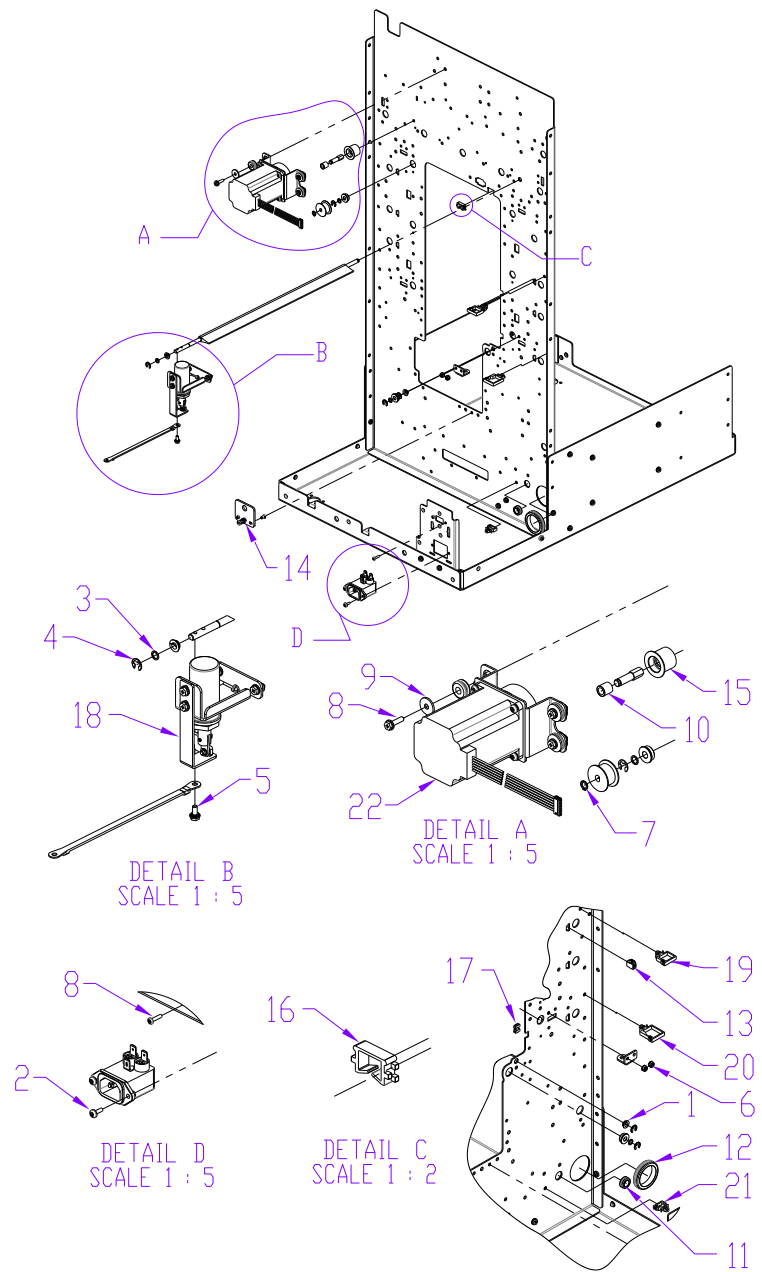

ITEM	GBC Part #	DESCRIPTION	QTY
1	1821209 ^D	SNAP-IN BEARING, 6MM ID	2
2	1821611 ^B	SCREW, PHILLIPS HD W/SEMS, M3X10	2
3	1822005 ^C	WASHER, FLAT, 6.025 X 8 X 0.75	2
4	1822202 ^A	E-RING, JE-5	7
5	1823910 ^B	SCREW, PHILLIPS HX HD W/SEMS M4 X 14	12
6	1824001 ^B	NUT, KEPS M4	32
7	1825501 ^A	RETAINING RING, 6MM SHAFT	15
8	1902863 ^B	SCREW, PAN #4-40X15/32 PHILLIPS	2
9	1925044 ^C	WSHR, .192 ID X .625 OD X .060 T	20
10	1952208	SPACER, TIMING BELT IDLERS, BRONZE	4
11	1954011	GROMMET, 3/8 I.D X 1/2 O.D	11
12	1954032	GROMMET, 1 1/4 I.D. X 1 1/2 O.D.	1
13	7712703	WIRE HEADER CONNECTOR, 2 POS	6
14	7715185	BRACKET, PUNCH MODULE MOUNT	2
15	7715383	ROLLER, IDLER, DRIVE ASSY,	4
16	7715390 ^E	WIRE CLAMP, EDGE	1
17	7715445 ^E	WIRE CLAMP, EDGE, SMALL	2
18	7715595	SOLENOID,BRACKET,DIVERTER,SUB ASSY	1
19	7715818 ^E	WIRE SADDLE, MEDIUM, LOCKING TOP	10
20	7715819 ^E	WIRE SADDLE, LARGE, LOCKING TOP	8
21	7715817 ^E	WIRE SADDLE, SMALL, LOCKING TOP	32
22	PL 3.6	STEPPER AND MOUNT ASSEMBLY	5
A	7715973	KIT, HARDWARE, RINGS	
B	7715974	KIT, HARDWARE, FASTENERS	
C	7715975	KIT, HARDWARE, WASHERS	
D	7715976	KIT, HARDWARE, BEARINGS	
E	7715977	KIT, HARDWARE, WIRE CLAMPS	

PL 3.4. Frame Assembly- Drive Rollers

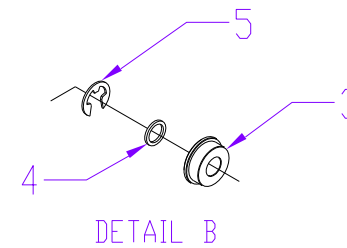
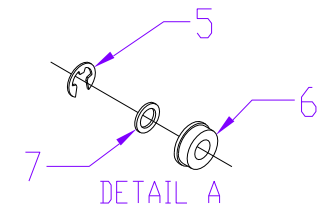
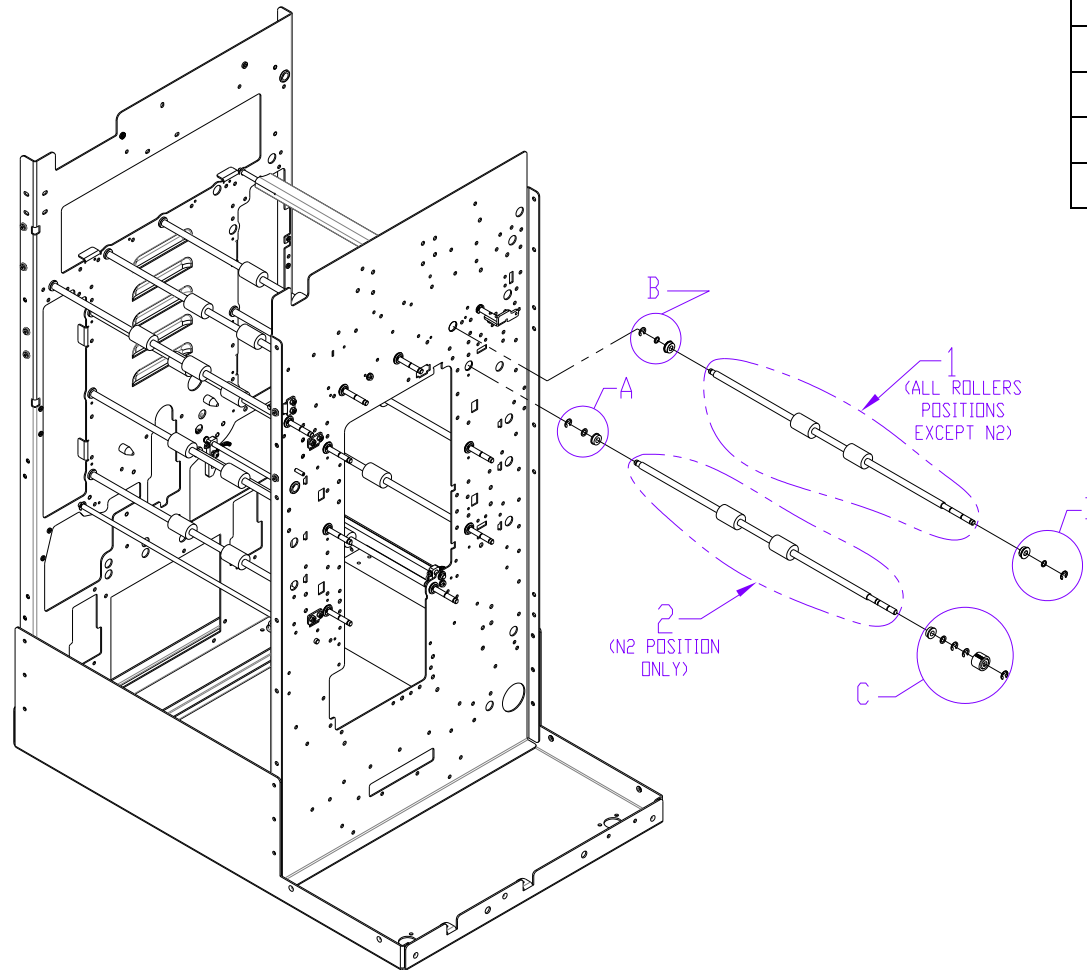
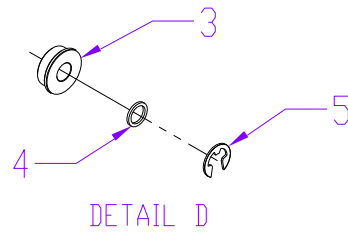
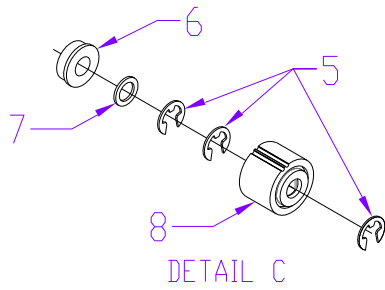

ITEM	GBC Part #	DESCRIPTION	QTY
1	7715093	ROLLER ASSY, DRIVE (USED FOR ALL ROLLERS EXCEPT N2)	11
2	7715097	ROLLER ASSY, ONE WAY DRIVE (USED IN N2 POSITION ONLY)	1
3	1821116 ^D	BEARING,BALL,FLANGE 6X13X5, SUJ2	22
4	1822005 ^C	WASHER, FLAT, 6.025 X 8 X 0.75	22
5	1822202 ^A	E-RING, JE-5	26
6	7706532	BEARING BALL FLANGE	2
7	1925222 ^C	WASHER FLAT, 1/4X3/8X1/32	2
8	7715862	ONE WAY CLUTCH SUB ASSEMBLY	1
A	7715973	KIT, HARDWARE, RINGS	
C	7715975	KIT, HARDWARE, WASHERS	
D	7715976	KIT, HARDWARE, BEARINGS	

PL 3.5. Frame Assembly- Internal Parts

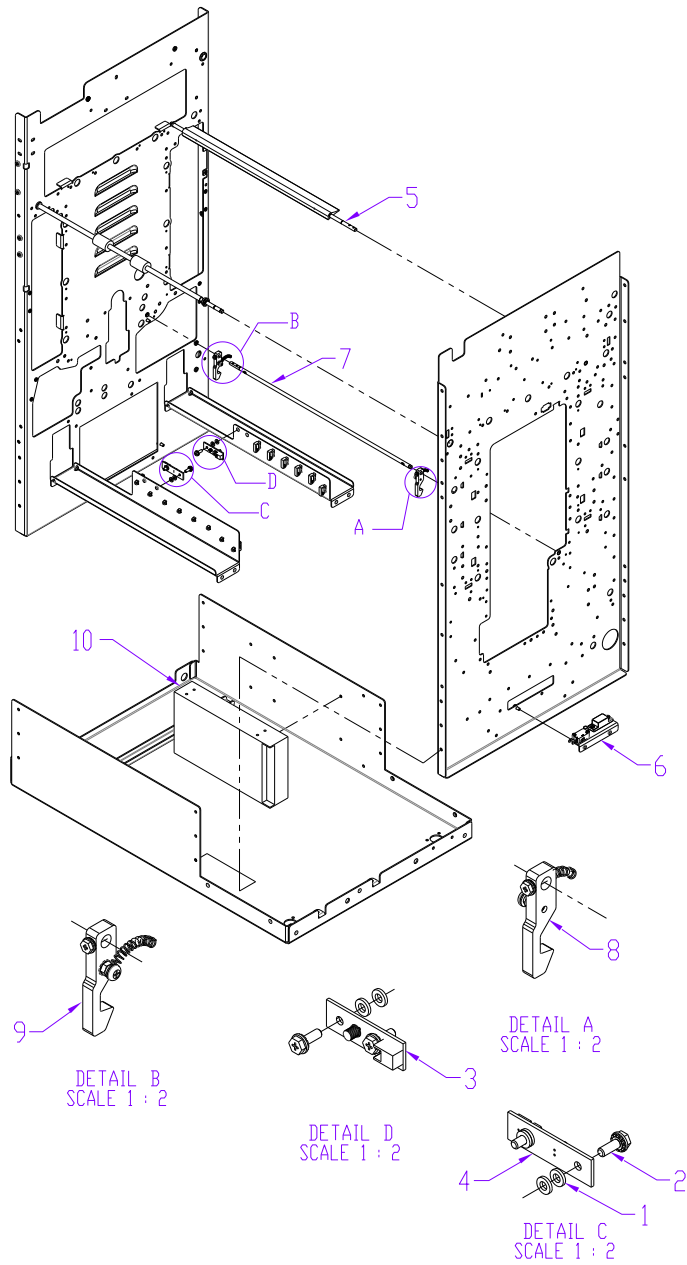

ITEM	GBC Part #	DESCRIPTION	QTY
1	1822108 ^C	WASHER, FLAT, 4.1X8X1.5	8
2	1823911 ^B	SCREW, PHILLIPS HX HD W/SEMS M4 X 10	4
3	7711970	EMITTER	1
4	7711973	RECEIVER	1
5	7715418	BYPASS DIVERTER	1
6	7715186	CHIP TRAY SENSOR MOUNT ASSY	1
7	7715213	SHAFT, ACCEL IDLER LATCH	1
8	7715216	LATCH,ASSY, FRONT, ACCEL IDLER PANEL	1
9	7715222	LATCH,ASSY, REAR, ACCEL IDLER PANEL	1
10	7715637	POWER SUPPLY, 24V, MW SP 480,	1
B	7715974	KIT, HARDWARE, FASTENERS	
C	7715975	KIT, HARDWARE, WASHERS	

PL 3.6. Frame Assembly- Motors and Motor Drivers

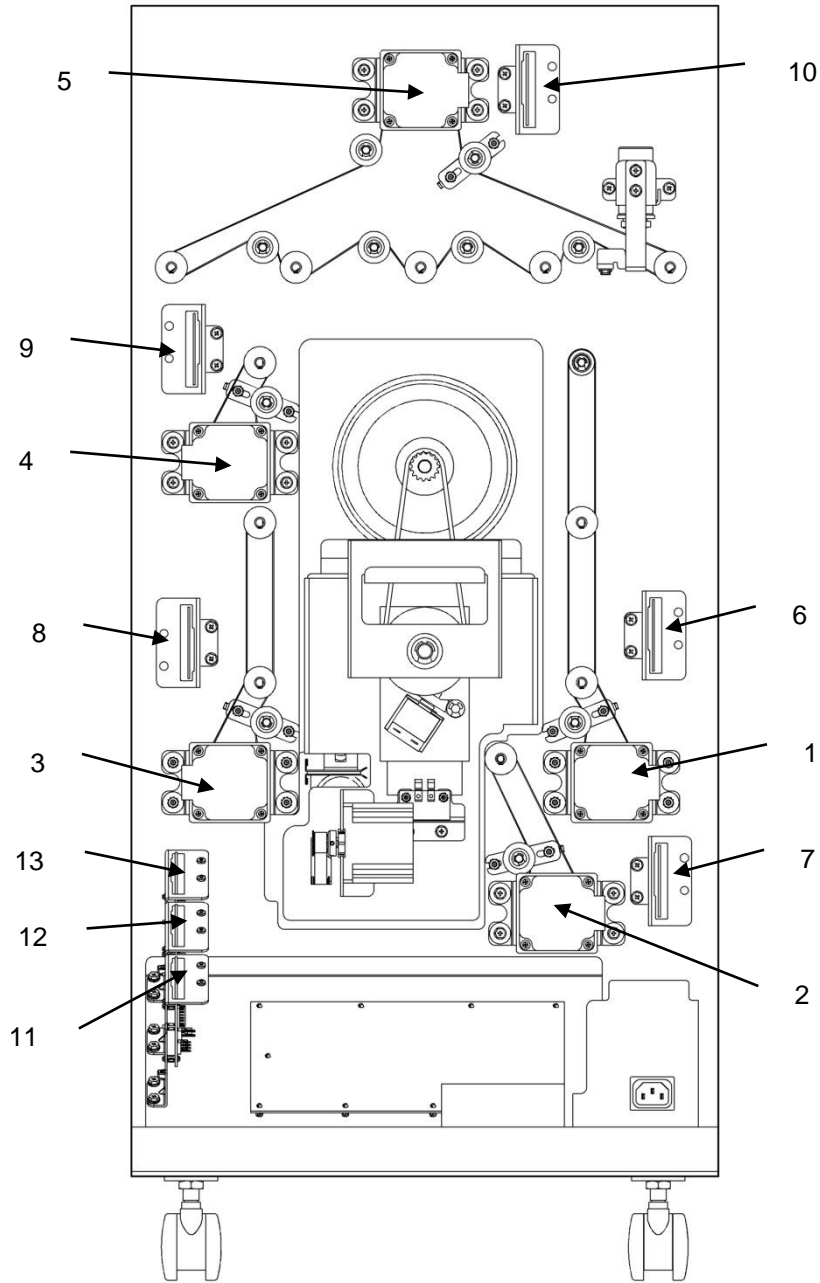

ITEM	GBC Part #		DESCRIPTION	QTY
1	7715159	M1	ENTRANCE MOTOR STEPPER AND MOUNT ASSY	1
2	7715159	M2	ACCEL MOTOR STEPPER AND MOUNT ASSY	1
3	7715159	M6	EXIT MOTOR STEPPER AND MOUNT ASSY	1
4	7715159	M7	DECEL MOTOR STEPPER AND MOUNT ASSY	1
5	7715159	M8	BYPASS MOTOR STEPPER AND MOUNT ASSY	1
6	7715275	DRV M1	M1 STEPPER DRIVER DRIVER AND BRACKET ASSY, TWO PHASE	1
7	7715275	DRV M2	M2 STEPPER DRIVER DRIVER AND BRACKET ASSY, TWO PHASE	1
8	7715275	DRV M6	M6 STEPPER DRIVER DRIVER AND BRACKET ASSY, TWO PHASE	1
9	7715275	DRV M7	M7 STEPPER DRIVER DRIVER AND BRACKET ASSY, TWO PHASE	1
10	7715275	DRV M8	M8 STEPPER DRIVER DRIVER AND BRACKET ASSY, TWO PHASE	1
11	7715275	DRV M3	M3 STEPPER DRIVER DRIVER AND BRACKET ASSY, TWO PHASE	1
12	7715275	DRV M4	M4 STEPPER DRIVER DRIVER AND BRACKET ASSY, TWO PHASE	1
13	7715275	DRV M5	M5 STEPPER DRIVER DRIVER AND BRACKET ASSY, TWO PHASE	1

PL 3.7. Frame Assembly- Sensors

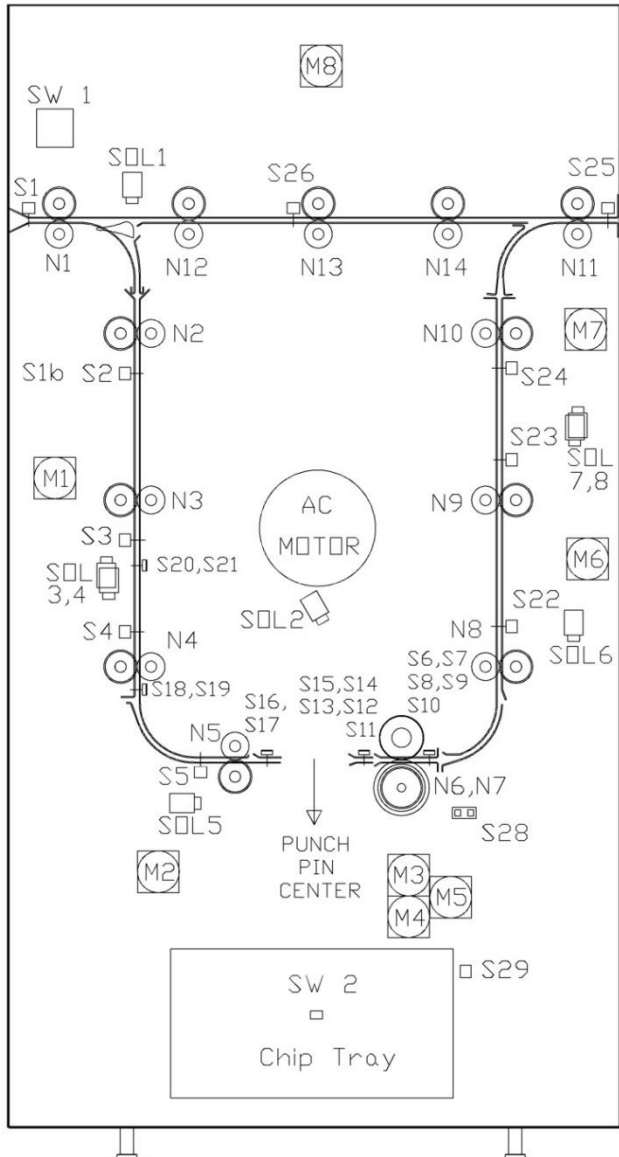

*For machines with matrix tag 1-2 or no mark, use 130N01766. For all others use 130N01912.

ITEM	GBC Part #		DESCRIPTION	QTY
1	7715627	S1	ENTRANCE SENSOR, S1	1
2	7715291	S2	ENTRANCE SENSOR, TOP	1
3	7715291	S3	ENTRANCE SENSOR, MIDDLE	1
4	7715291	S4	ENTRANCE SENSOR, BOTTOM	1
5	7715291	S5	ACCEL SENSOR	1
6	7715692	S6 S7 S8 S9 S10	SKEW SENSOR BOARD	1
7	7715694*	S11 S12	ALIGNMENT SENSOR BOARD	1
	Z7718567*	S13 S14 S15	ALIGNMENT SENSOR BOARD, SWITCHABLE	1
8	Z7724178	S16 S17	BACKAGE SENSOR BOARD ASSY	1
9	Z7724178	S18 S19	MID PUNCH LARGE, SENSOR BACKAGE SENSOR BOARD ASSY	1
10	Z7724178	S20 S21	MID PUNCH X- LARGE, SENSOR BACKAGE SENSOR BOARD ASSY	1
11	7715291	S22	EXIT SENSOR, BOTTOM	1
12	7715291	S23	EXIT SENSOR, MIDDLE	1
13	7715291	S24	EXIT SENSOR, TOP	1
14	7715291	S25	EXIT SENSOR	1
15	7715291	S26	BYPASS SENSOR, MIDDLE	1
16	7715340	S27	BYPASS OPEN SENSOR	1
17	7715597	S28	ALIGN HOME SENSOR	1
18	7711970	S29	CHIP LEVEL SENSOR - EMITTER	1
	7711973	S29	CHIP LEVEL SENSOR - RECEIVER	1
19	7715774	S1B	CLEAR COVER SENSOR-EMITTER	1
	7711973	S1B	CLEAR COVER SENSOR-RECEIVER	1

PL 3.8. Frame Assembly- Solenoids / Switches

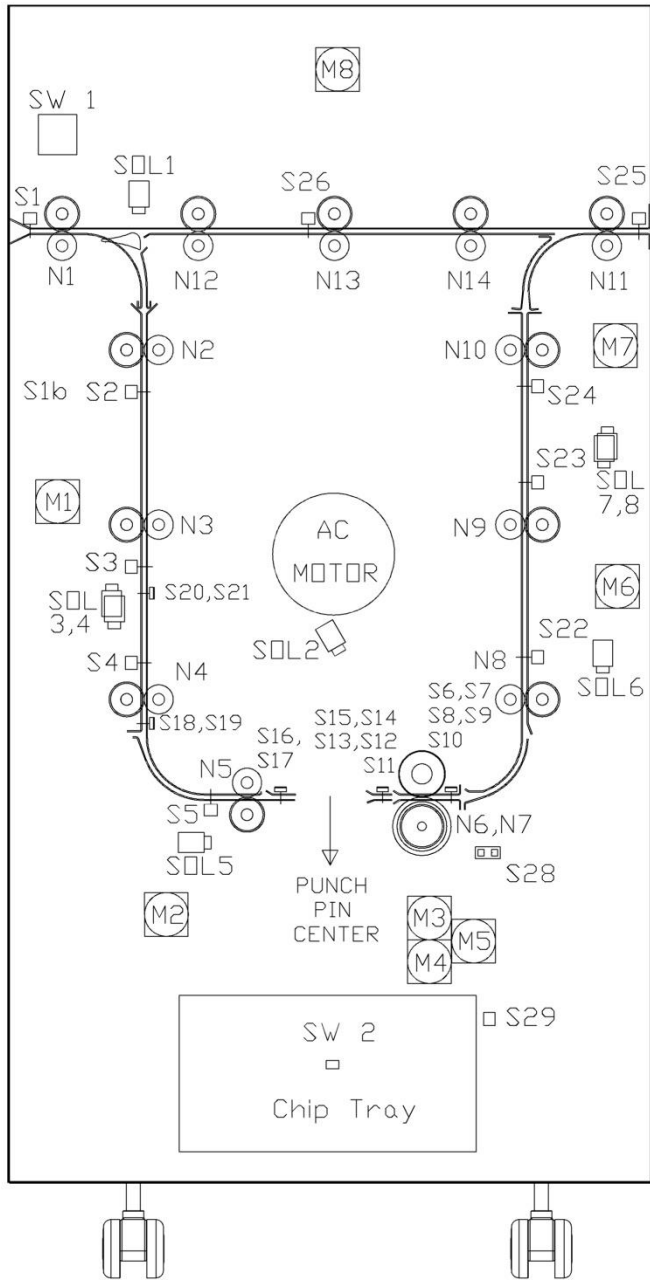

ITEM	GBC Part #		DESCRIPTION	QTY
1	7715595	SOL 1	DIVERTER SUBASSEMBLY	1
2	7715020	SOL 2	PUNCH CLUTCH	1
3	7715223	SOL 3	ENTRANCE IDLER SOLENOID, MIDDLE	1
4	7715223	SOL 4	ENTRANCE IDLER SOLENOID, BOTTOM	1
5	7715223	SOL 5	ACCELERATION ROLLER SOLENOID	1
6	7715223	SOL 6	EXIT IDLER SOLENOID, BOTTOM	1
7	7715223	SOL 7	EXIT IDLER SOLENOID, MIDDLE	1
8	7715223	SOL 8	EXIT IDLER SOLENOID, TOP	1
9	7610501	SW1	FRONT DOOR INTERLOCK SWITCH	1
10	7715186	SW2	CHIP TRAY HOME SWITCH ASSEMBLY	1

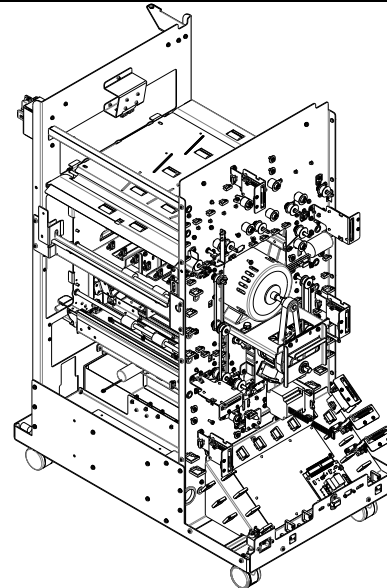

PL 3.9. Frame Assembly- Belts and Pulleys

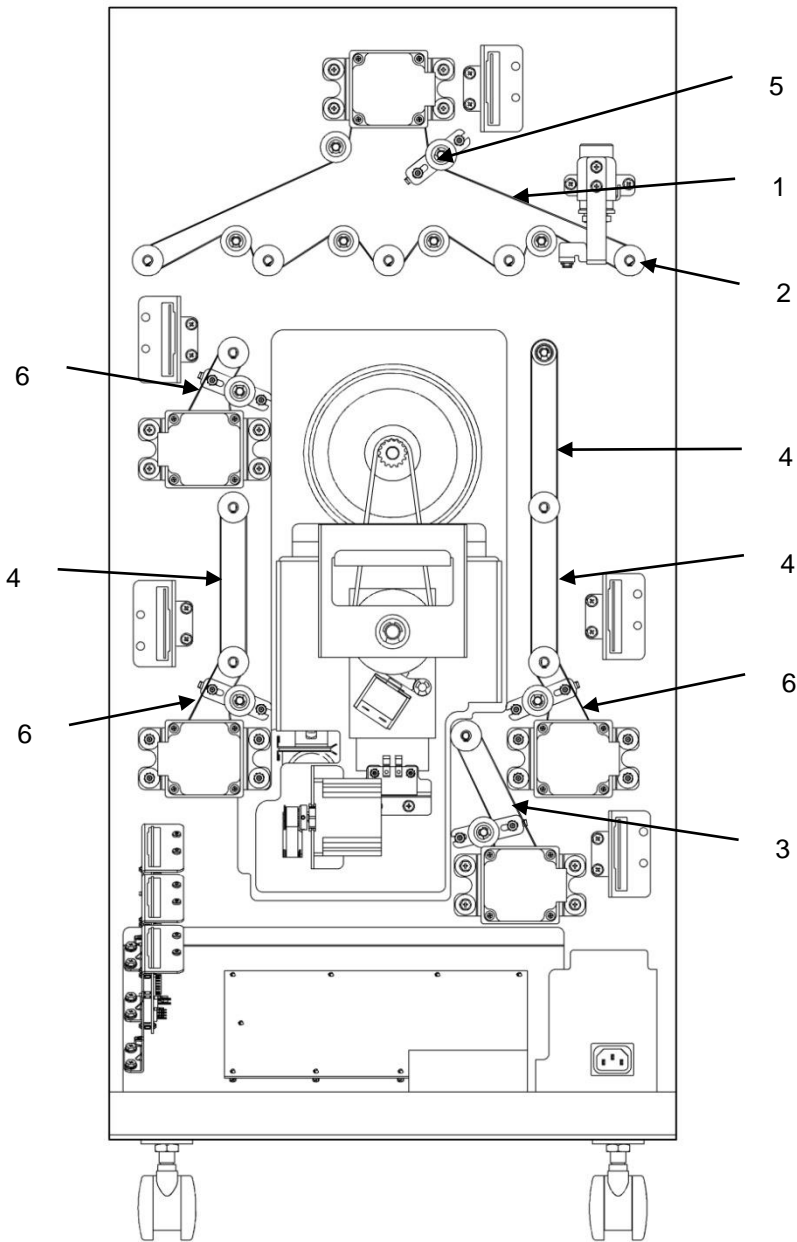

ITEM	GBC Part #	DESCRIPTION	QTY
1	7715202	BELT, 534T, 2MM 2GT	1
2	7715204	PULLEY,TIMING,2MM 2GT,30T	14
3	7715206	BELT, 179T, 2MM 2GT	1
4	7715243	BELT, 150 T, 2MM 2GT	3
5	7715245	TENSIONER ASSEMBLY	5
6	7715246	BELT, 134T, 2MM 2GT	3

Paper Path

PL 4.1. Paper Path- Entrance Drive Panel

ITEM	GBC Part #		DESCRIPTION	QTY
1	1824002 ^B		NUT, KEPS, M3	6
2	7711973	S1b	RECEIVER	1
3	Z7724178	S18 S19	MID PUNCH, LARGE, SENSOR BOARD BOARD ASSY, BACKGAGE SENSOR	1
	Z7724178	S20 S21	MID PUNCH, X LARGE, SENSOR BOARD BOARD ASSY, BACKGAGE SENSOR	1
4	7715851		PANEL WELDMENT,DRIVE,ENTRANCE	1
5	1822108 ^C		WASHER, FLAT, 4.1X 8X1.5	4
6	1822117 ^C		WASHER, 3.2ID, 8OD, 0.75MM THICK	12
7	1823903 ^B		SCREW, PHILLIPS, HX HD M4X8	2
B	7715974		KIT, HARDWARE, FASTENERS	
C	7715975		KIT, HARDWARE, WASHERS	

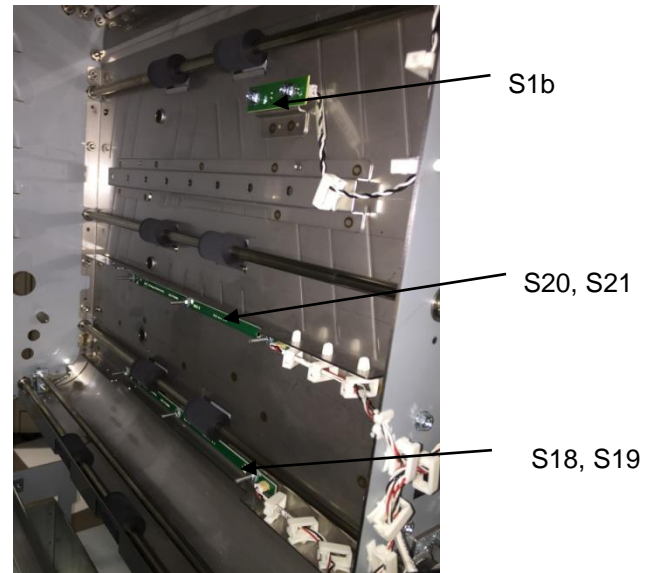
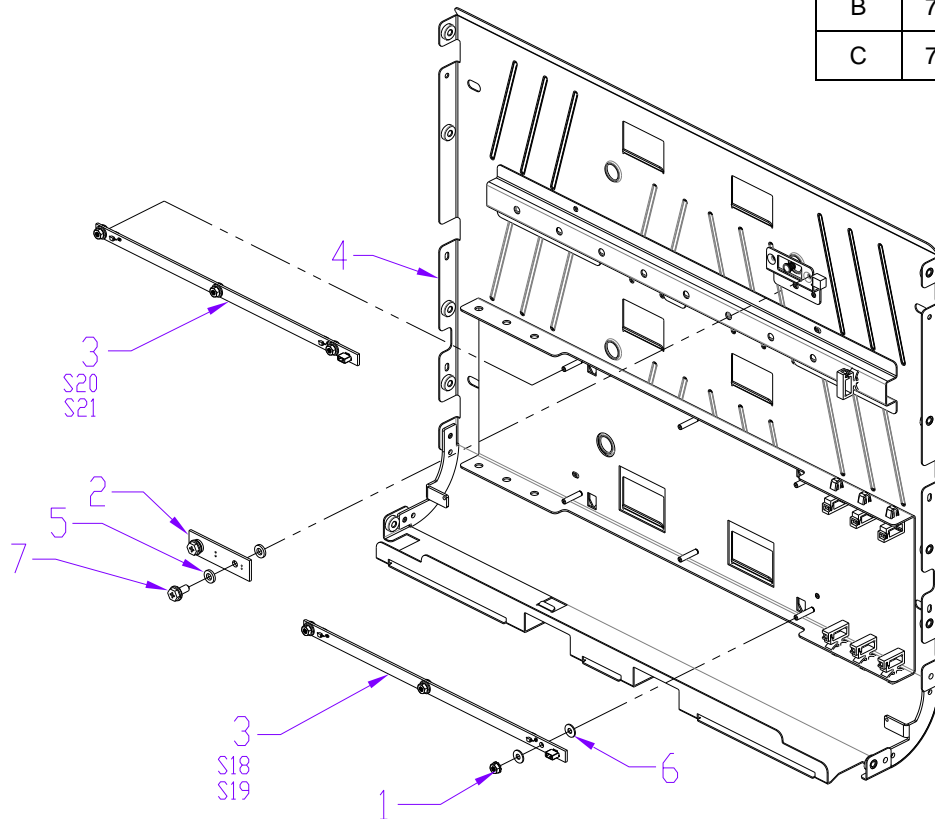

PL 4.2. Paper Path- Entrance Idler Panel

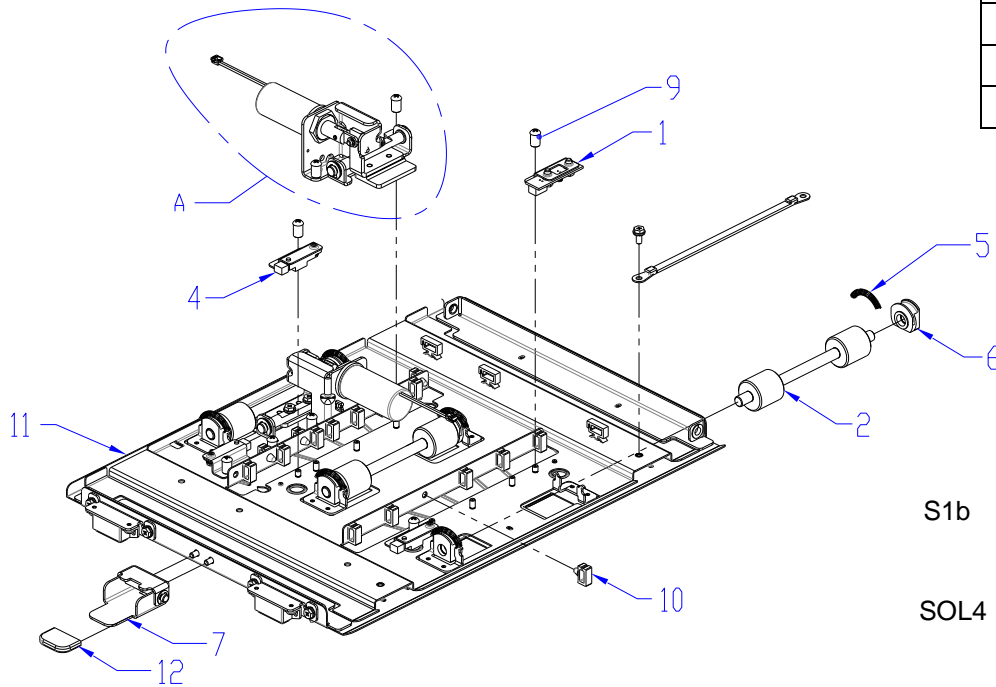
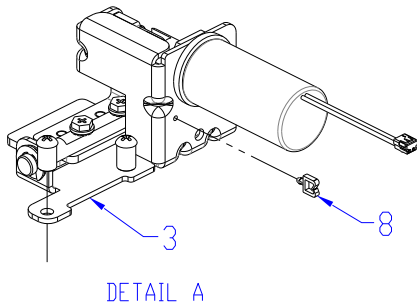

ITEM	GBC Part #		DESCRIPTION	QTY
1	7711970	S1b	EMITTER	1
2	7715103		ROLLER ASSY, IDLER	3
3	PL 4.6	SOL3 SOL4	MODULE,SOLENOID,DISENGAGING ROLLER	2
4	7715291	S2 S3 S4	SENSOR AND BRACKET ASSY	3
5	7715380 ^F		SPRING,TRANSPORT IDLR ROLLER	6
6	7715382		BEARING HOUSING	6
7	7715384		HANDLE ASSY, IDLER PANELS	1
8	7715625 ^E		WIRE SADDLE, SHORT	2
9	7715629 ^B		SCREW, BARREL, M4, 7MM DEEP	13
10	7715639 ^E		WIRE SADDLE,SMALL,SIDE OPEN	11
11	7715853		PANEL WLDMT,IDLER,ENTRY	1
12	7708163		CAP, RUBBER	1
B	7715974		KIT, HARDWARE, FASTENERS	
E	7715977		KIT, HARDWARE, WIRE CLAMPS	
F	7715978		KIT, HARDWARE, SPRINGS	

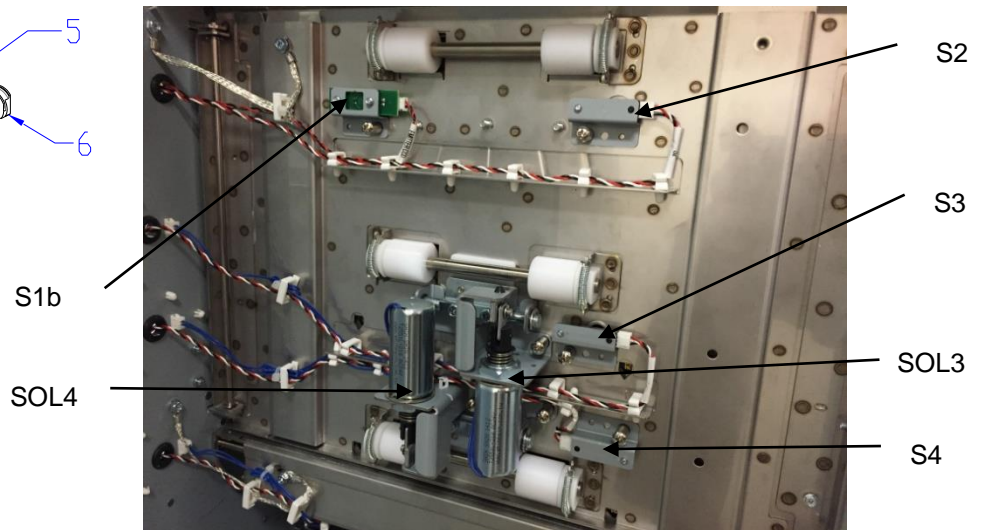

PL 4.3. Paper Path- Acceleration Roller Idler

ITEM	GBC Part #		DESCRIPTION	QTY
1	7708163		CAP, RUBBER	1
2	7715103		ROLLER ASSY, IDLER	1
3	PL 4.6	SOL5	MODULE, SOLENOID, DISENGAGING ROLLER	1
4	7715291	S5	SENSOR AND BRACKET ASSY	1
5	7715380 ^F		SPRING, TRANSPORT IDLR ROLLER	2
6	7715382		BEARING HOUSING ASSY	2
7	7715817 ^E		WIRE SADDLE, SMALL	5
8	7715629 ^B		SCREW, BARREL, M4, 7MM DEEP	4
9	7715855		PANEL WLDMNT, IDLER, ACCEL	1
B	7715974		KIT, HARDWARE, FASTENERS	
E	7715977		KIT, HARDWARE, WIRE CLAMPS	
F	7715978		KIT, HARDWARE, SPRINGS	

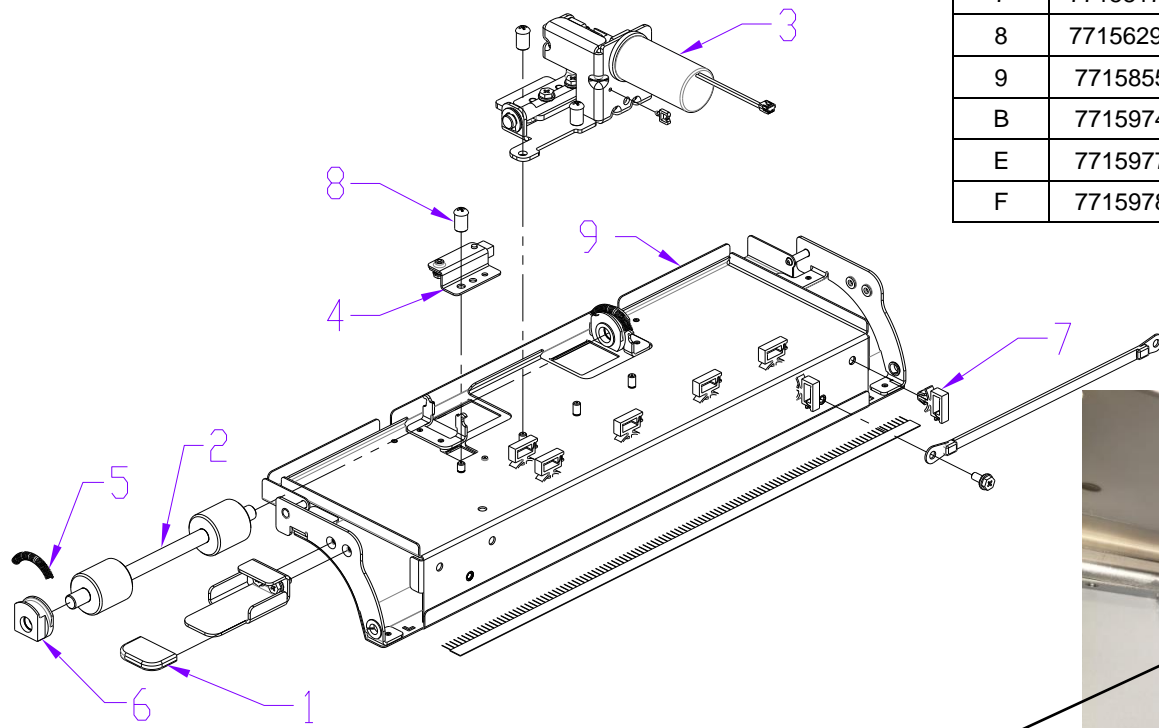

S5



SOL5

PL 4.4. Paper Path- Exit Idler Panel

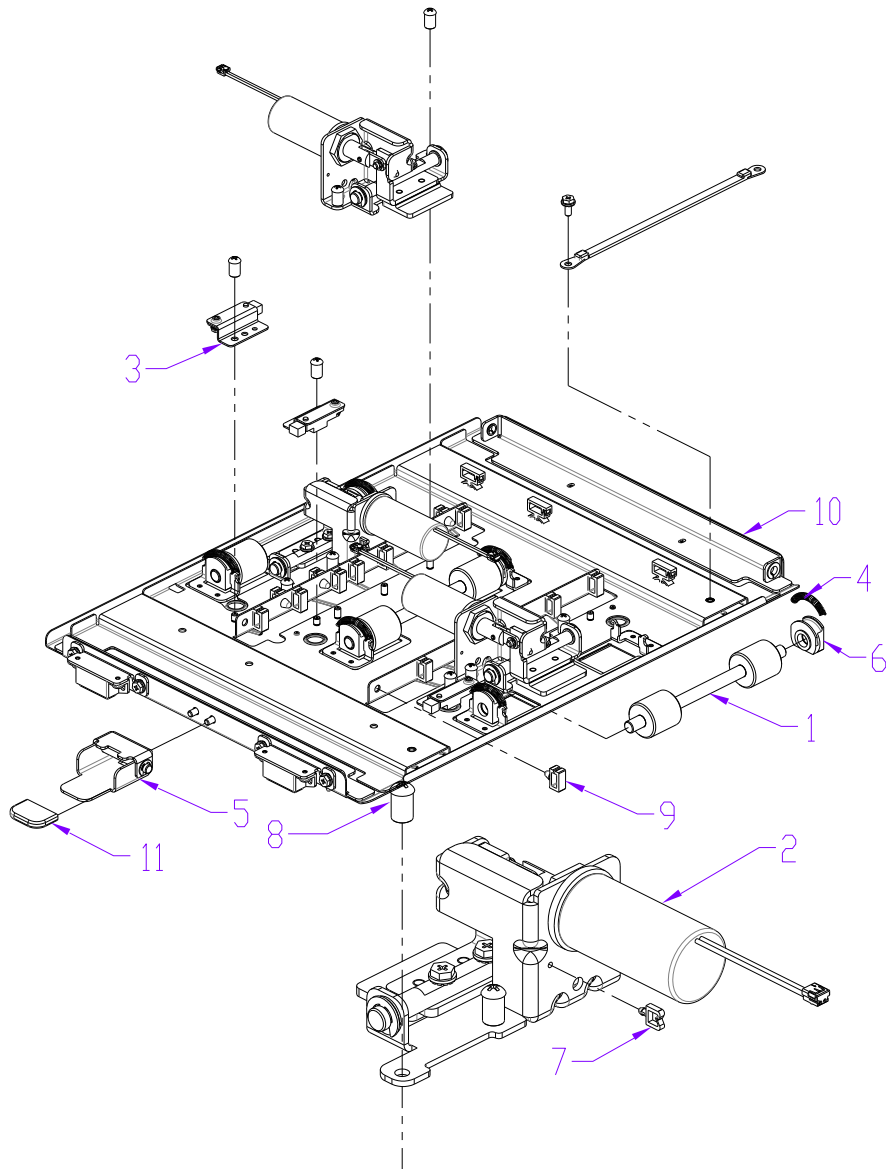

ITEM	GBC Part #		DESCRIPTION	QTY
1	7715103		ROLLER ASSY, IDLER	3
2	PL 4.6	SOL6 SOL7	MODULE,SOLENOID, DISENGAGING ROLLER	3
3	7715291	S22 S23	SENSOR AND BRACKET ASSY	3
4	7715380 ^F		SPRING,TRANSPORT IDLER ROLLERS	6
5	7715384		HANDLE ASSY,IDLER PANEL	1
6	7715382		BEARING HOUSING ASSY	6
7	7715625 ^E		WIRE SADDLE, SHORT	3
8	7715629 ^B		SCREW,BARREL,M4	12
9	7715639 ^E		WIRE SADDLE,SIDE OPEN	8
10	7715854		PANEL WLDMNT,IDLER,EXIT	1
11	7708163		CAP, RUBBER	1
B	7715974		KIT, HARDWARE, FASTENERS	
E	7715977		KIT, HARDWARE, WIRE CLAMPS	
F	7715978		KIT, HARDWARE, SPRINGS	

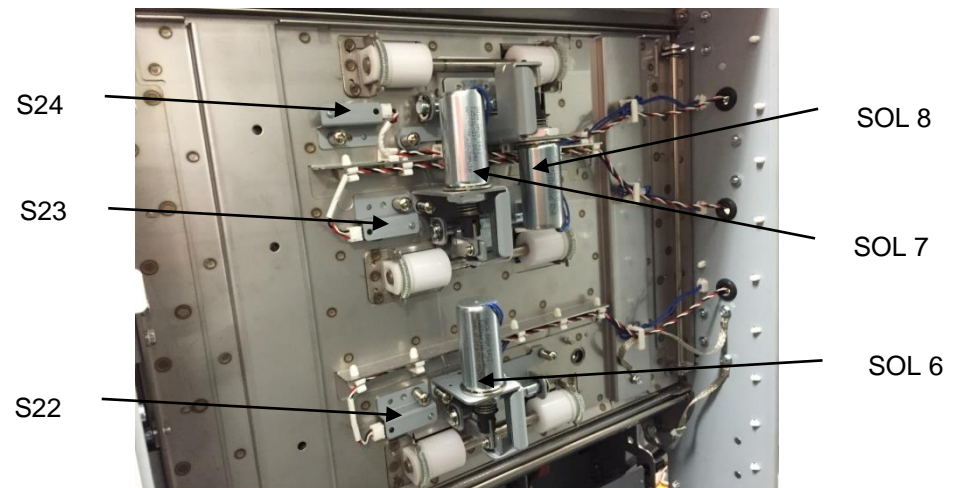

PL 4.5. Paper Path- Upper Bypass Panel

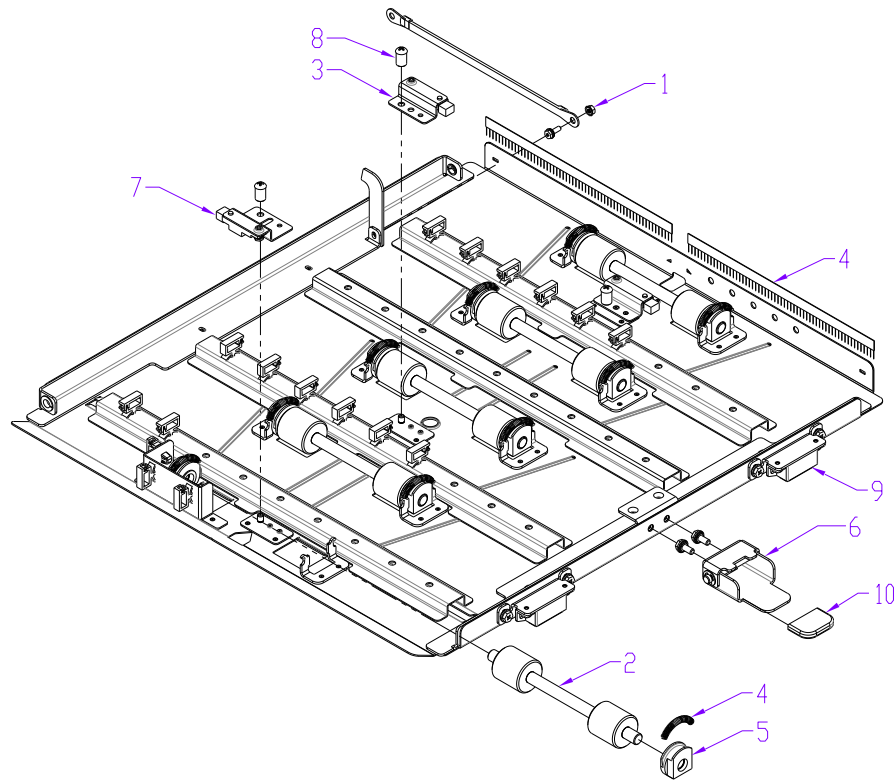

ITEM	GBC Part #		DESCRIPTION	QTY
1	1824002 ^B		NUT, KEPS, M3	1
2	7715103		ROLLER ASSY, IDLER	5
3	7715291	S25 S26	SENSOR AND BRACKET ASSEMBLY	2
4	7715380 ^F		SPRING, TRANSPORT IDLER ROLLER	10
5	7715382		BEARING HOUSING ASSY	10
6	7715384		HANDLE ASSY, IDLER PANELS	1
7	7715627	S1	SENSOR AND BRACKET ASSY,S1	1
8	7715629 ^B		SCREW, BARREL, M4, 7MM DEEP	3
9	7715852		PANEL WELDMENT, BYPASS, UPPER	1
10	7708163		CAP, RUBBER	1
B	7715974		KIT, HARDWARE, FASTENERS	
C	7715975		KIT, HARDWARE, WASHERS	
F	7715978		KIT, HARDWARE, SPRINGS	

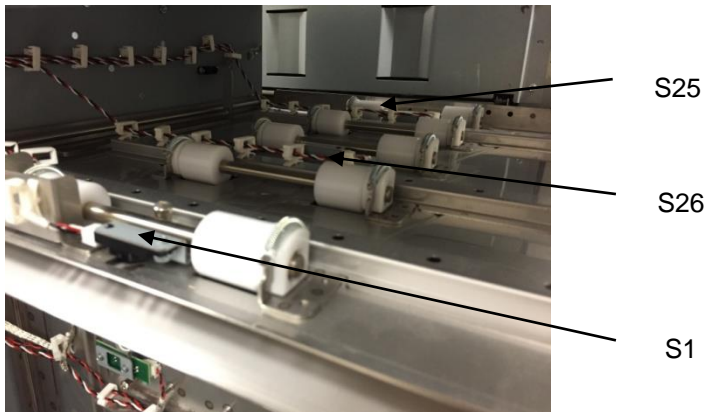

PL 4.6. Paper Path- Disengaging Roller Solenoid

ITEM	GBC Part #		Description	QTY
1	7715223	SOL 3 SOL 4 SOL 5 SOL 6 SOL 7 SOL 8	MODULE, SOLENOID, DISENGAGING ROLLER	6

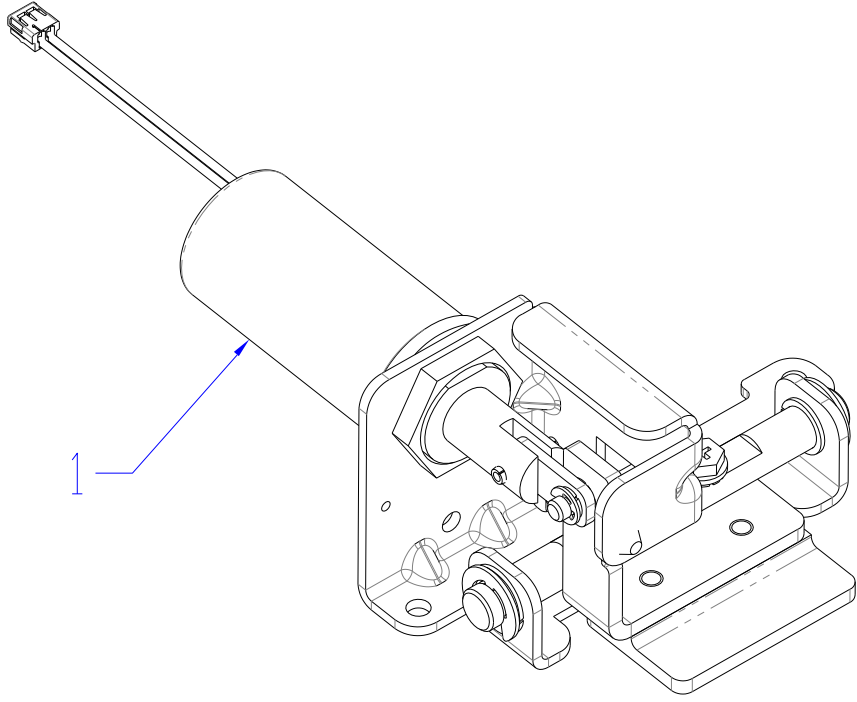

Punch Module

PL 5.1. Punch Module

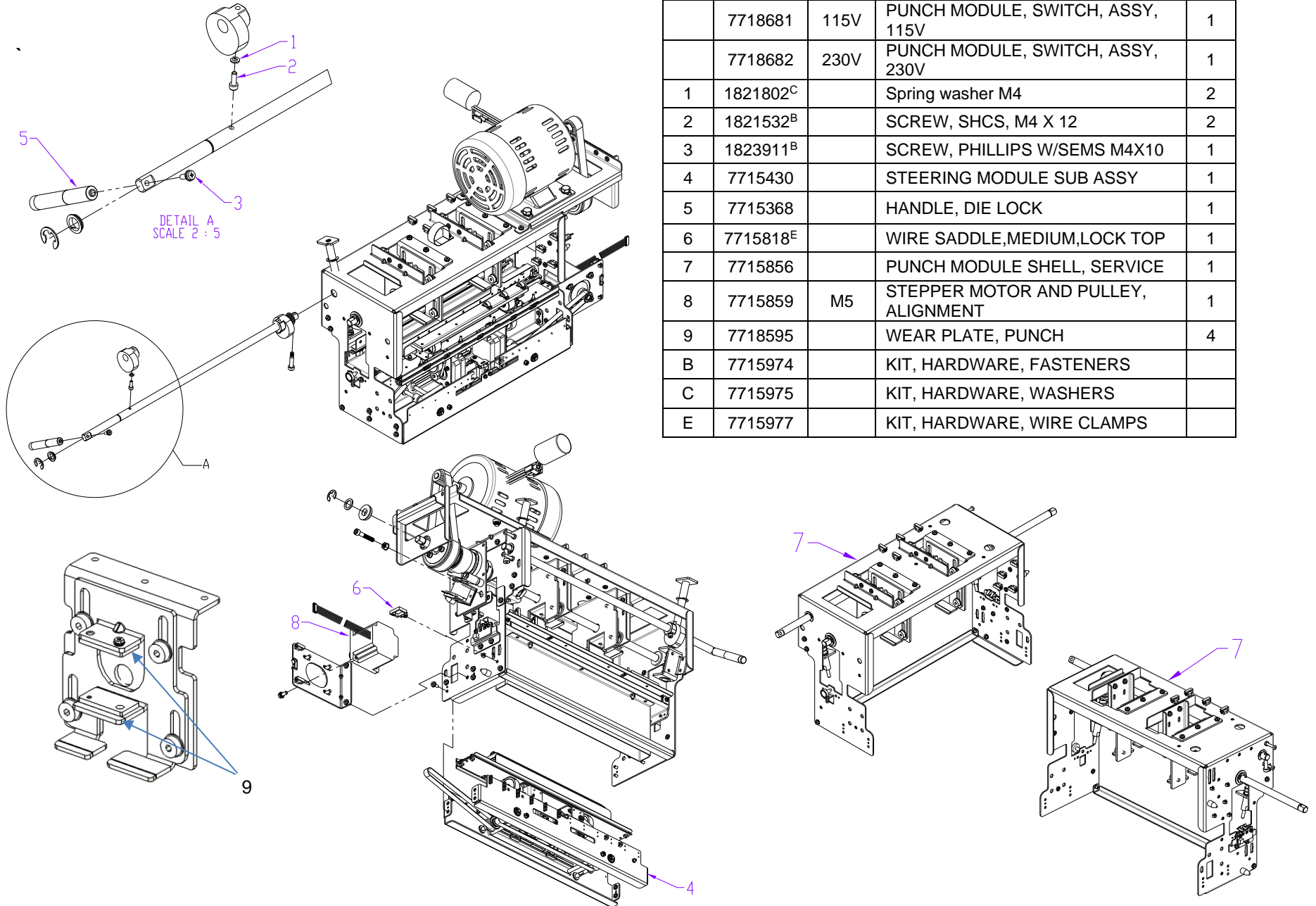

ITEM	GBC Part #		DESCRIPTION	QTY
	7718681	115V	PUNCH MODULE, SWITCH, ASSY, 115V	1
	7718682	230V	PUNCH MODULE, SWITCH, ASSY, 230V	1
1	1821802 ^C		Spring washer M4	2
2	1821532 ^B		SCREW, SHCS, M4 X 12	2
3	1823911 ^B		SCREW, PHILLIPS W/SEMS M4X10	1
4	7715430		STEERING MODULE SUB ASSY	1
5	7715368		HANDLE, DIE LOCK	1
6	7715818 ^E		WIRE SADDLE, MEDIUM, LOCK TOP	1
7	7715856		PUNCH MODULE SHELL, SERVICE	1
8	7715859	M5	STEPPER MOTOR AND PULLEY, ALIGNMENT	1
9	7718595		WEAR PLATE, PUNCH	4
B	7715974		KIT, HARDWARE, FASTENERS	
C	7715975		KIT, HARDWARE, WASHERS	
E	7715977		KIT, HARDWARE, WIRE CLAMPS	

PL 5.1. Punch Module (continued)

ITEM	GBC Part #		DESCRIPTION	QTY
1	1821541 ^B		SCREW, SOCKET HD,M6,35MM LONG	1
2	1821655 ^B		SCREW, PHILLIPS, PAN HD, M4X25	2
3	7715232	115V	BELT, TIMING, 82 GROOVE, 5MM HTD	1
	7715372	230V	BELT, TIMING, 80 GROOVE, 5MM HTD	1
4	7715238		BRACKET & BEARING ASSY,DIE LOCK	2
5	7715239		PLUNGER & STRIPPER,DIE LOCK	2
6	7715374 ^F		SPRING, DIE LOCK RETURN	2
7	1824001 ^B		NUT, KEPS M4	2
8	7715347		BOARD,DIESET RECOGNITION READER	1
9	PL 5.6		PUNCH CLUTCH, PULLEY	1
B	7715974		KIT, HARDWARE, FASTENERS	
F	7715978		KIT, HARDWARE, SPRINGS	

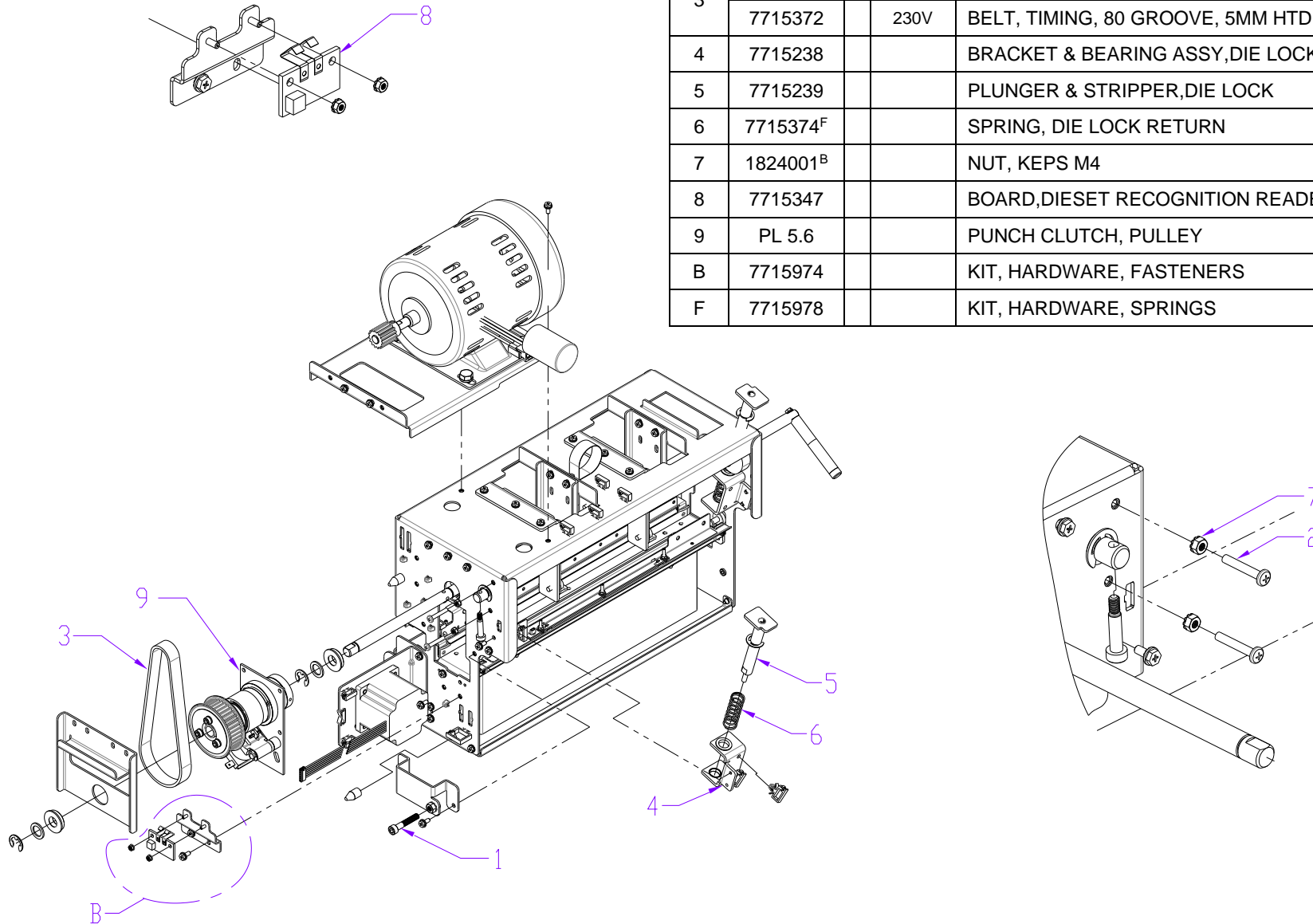

PL 5.2. Punch Module- Motors/Sensors

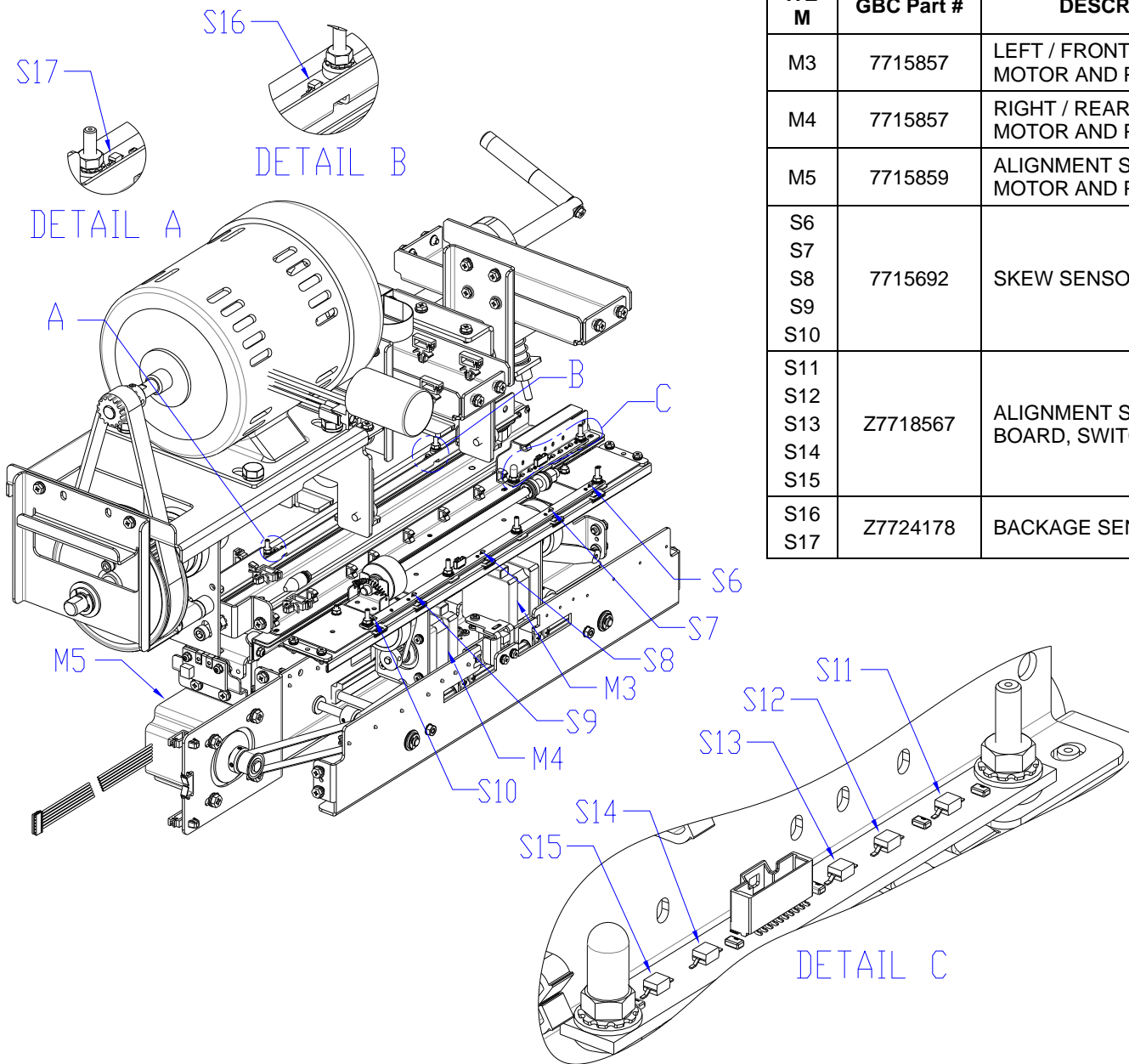

ITEM	GBC Part #	DESCRIPTION	QTY
M3	7715857	LEFT / FRONT STEERING MOTOR AND PULLEY.	1
M4	7715857	RIGHT / REAR STEERING MOTOR AND PULLEY.	1
M5	7715859	ALIGNMENT STEPPER MOTOR AND PULLEY.	1
S6 S7 S8 S9 S10	7715692	SKEW SENSOR BOARD	1
S11 S12 S13 S14 S15	Z7718567	ALIGNMENT SENSOR BOARD, SWITCHABLE	1
S16 S17	Z7724178	BACKAGE SENSOR BOARD	1

PL 5.3. Punch Module- Steering Module 7723440

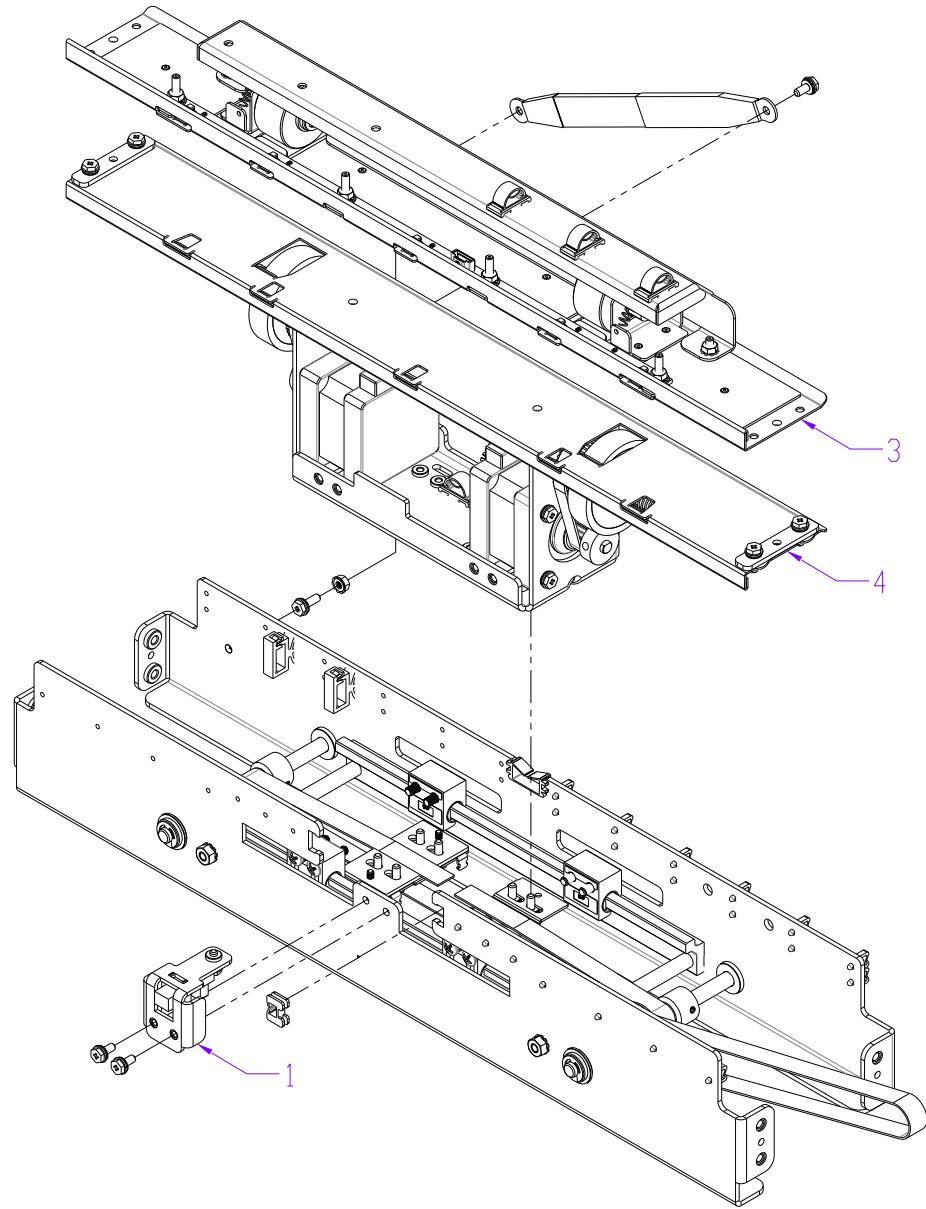

ITEM	GBC Part #		DESCRIPTION	QTY
1	7715597	S28	SENSOR, VEIN, BRACKET, SUB ASSLY	1
2	7715858		ALIGNMENT CARRIAGE,SUB ASSY, SERVICE	1
3	PL 5.4		STEERING IDLER PANEL SUB ASSEMBLY	
4	PL 5.5		STEERING DRIVE PANEL SUB ASSEMBLY	

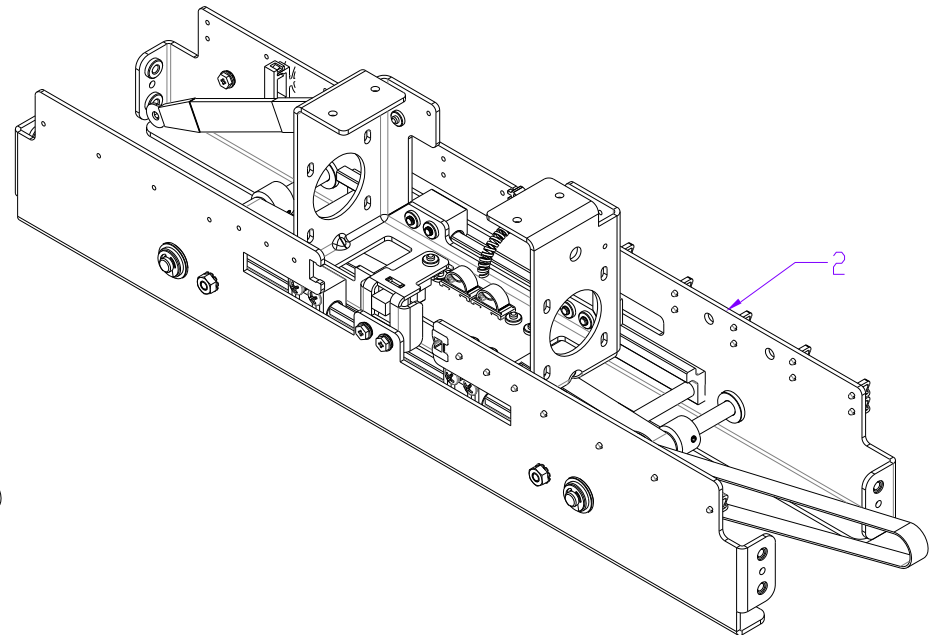

PL 5.4. Punch Module- Steering Module - Steering Idler Panel Sub Assembly

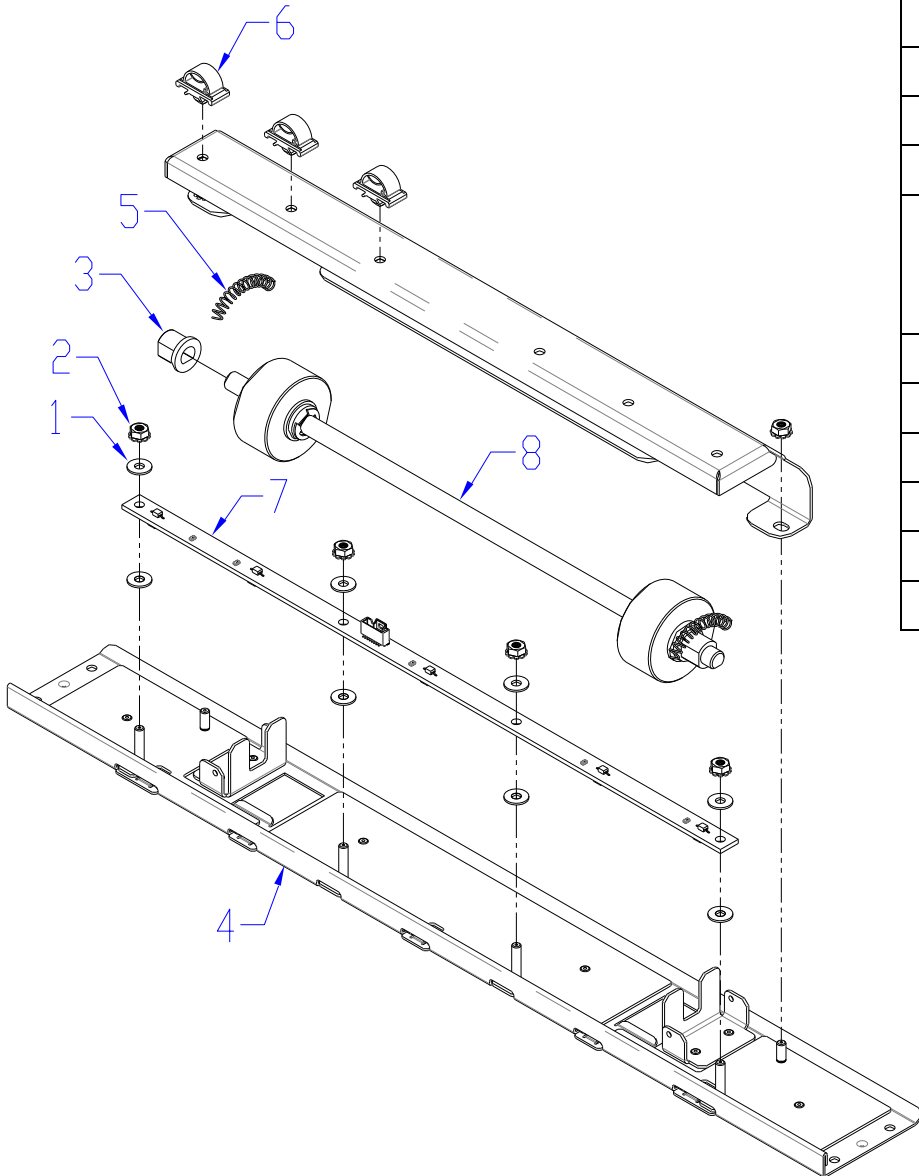

ITEM	GBC Part #		DESCRIPTION	QTY
1	1822117 ^C		WASHER, 3.2ID, 8OD, 0.75MM THK	8
2	1824002 ^B		NUT, KEPS, M3	6
3	7706488		BEARING, DOUBLE "D" FLANGE	2
4	7715062		PANEL WLDMENT, IDLER, STEERING	1
5	7715379 ^F		SPRING, STEERING IDLER ROLLER	2
6	7715648 ^E		WIRE CLAMP, LOCKING	3
7	7715692	S6 S7 S8 S9 S10	BOARD ASSY, SKEW SENSOR	1
8	7715816		ROLLER ASSY, IDLER, STEERING	1
B	7715974		KIT, HARDWARE, FASTENERS	
C	7715975		KIT, HARDWARE, WASHERS	
E	7715977		KIT, HARDWARE, WIRE CLAMPS	
F	7715978		KIT, HARDWARE, SPRINGS	

PL 5.5. Punch Module- Steering Module - Drive Panel Steering

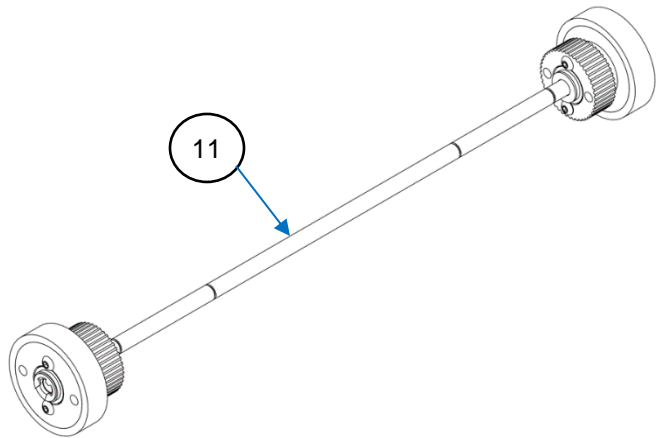
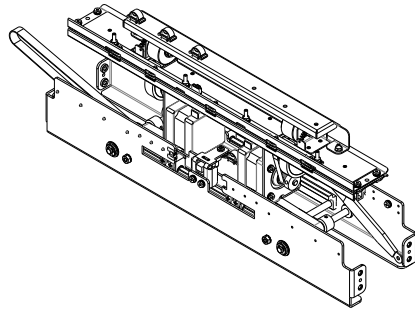

ITEM	GBC Part #		DESCRIPTION	QTY
1	1822008 ^C		WASHER, FLAT, 6.4X12X1.5	4
2	1822202 ^A		E-RING, JE-5	4
3	1823901 ^B		SCREW, PHILLIPS HX W/SEMS, M3X6	8
4	1824002 ^B		NUT, KEPS, M3	4
5	7715039		ROLLER ASSEMBLY, DRIVE, STEERING	2
6	7715047		BELT, STEERING, 65 GROOVES, 2MM 2GT	2
7	7715053		PANEL WELDMENT, DRIVE, STEERING	1
8	7715377 ^F		SPRING, STEERING DRIVE ROLLER	2
9	7715648 ^E		WIRE CLAMP, LOCKING	2
10	7715857	M3	STEPPER MOTOR AND PULLEY, STEERING, SERVICE	1
	7715857	M4	STEPPER MOTOR AND PULLEY, STEERING, SERVICE	1
11	7723432		ROLLER ASEMBLY, DRIVE, STEERING. SERVICE KIT	
A	7715973		KIT, HARDWARE, RINGS	
B	7715974		KIT, HARDWARE, FASTENERS	
C	7715975		KIT, HARDWARE, WASHERS	
E	7715977		KIT, HARDWARE, WIRE CLAMPS	
F	7715978		KIT, HARDWARE, SPRINGS	

PL 5.6. Punch Module- Punch Clutch

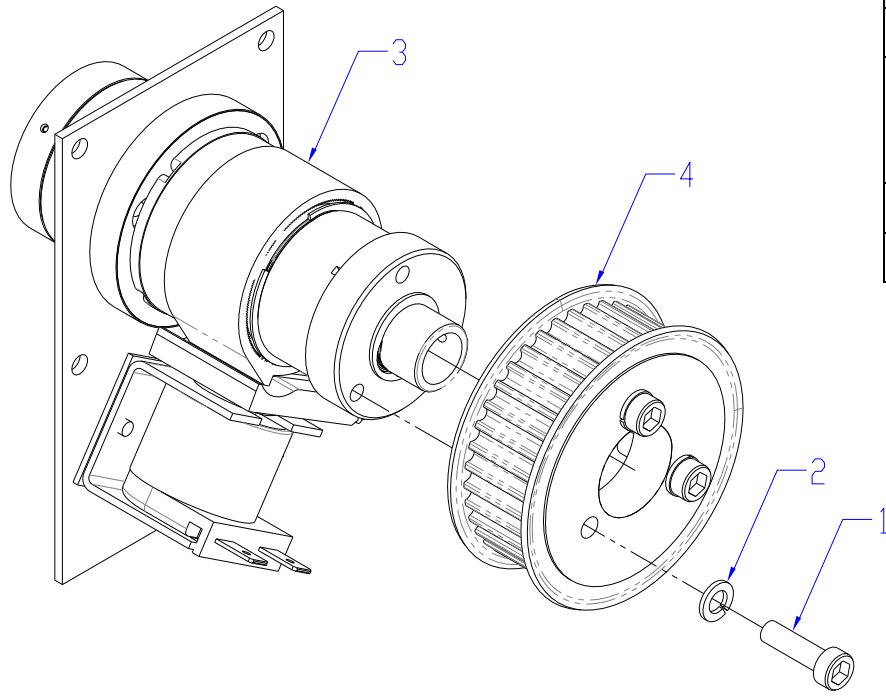

ITEM	GBC Part #		DESCRIPTION	QTY
1	1821531 ^B		SCREW, SHCS, M5X18	3
2	1821801 ^C		WASHER, SPLIT LOCK, M5	3
3	7715020		CLUTCH, WRAP SPRING	1
4	7715231	115V	PULLEY & FLANGE,5MM HTD,38T	1
	7715371	230V	PULLEY & FLANGE,5MM HTD,34T	1
B	7715974		KIT, HARDWARE, FASTENERS	
C	7715975		KIT, HARDWARE, WASHERS	

PL 5.8. Punch Module- Die Rail, Backgage, Align Sensors, Sub Assembly

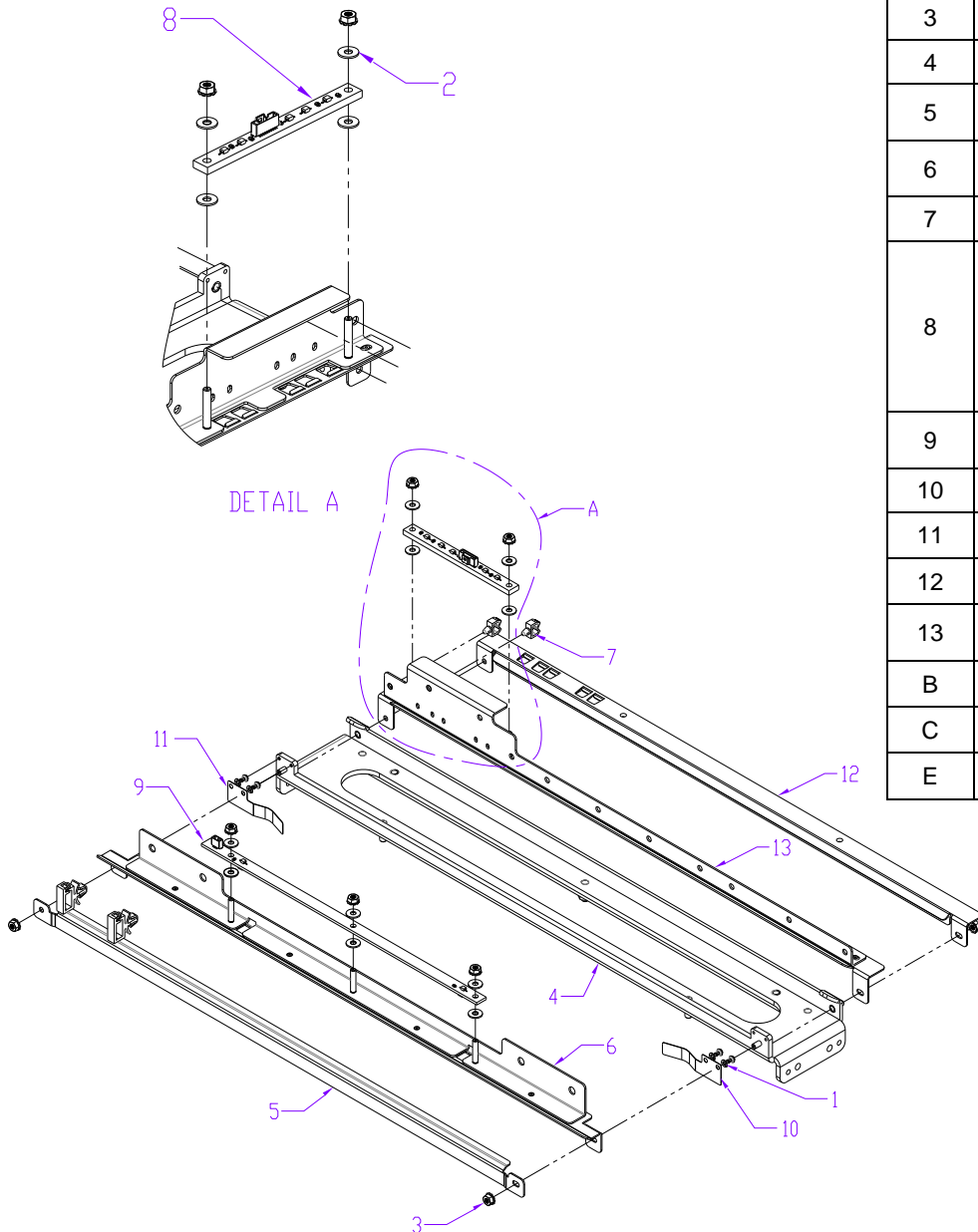

ITEM	GBC Part #		DESCRIPTION	QTY
1	1821808 ^C		LOCK WASHER, SPLIT, M2	4
2	1822117 ^C		WASHER, 3.2ID, 8OD, 0.75MM THK.	7
3	1824002 ^B		NUT, KEPS, M3	9
4	7715021		DIE RAIL, ASSEMBLY	1
5	7715032		BRACKET, BACKGAGE SENSOR, LOWER	1
6	7715080		BRACKET WLDMNT, BACKGAGE SENSOR	1
7	7715640 ^E		WIRE SADDLE, ALIGN SENSOR WIRES	9
8	Z7718567	S11 S12 S13 S14 S15	Alignment Sensor Board, Switchable	1
9	Z7724178	S16 S17	BOARD ASSY, BACKGAGE SENSOR	1
10	7715787		SPRING, DIE RAIL, POSITION, 1	1
11	7715799		SPRING, DIE RAIL, POSITION, 2	1
12	7715938		GUIDE, ALIGNMENT SENSOR, BOTTOM	1
13	7715941		BRACKET WELDMENT, ALIGNMENT SENSOR	1
B	7715974		KIT, HARDWARE, FASTENERS	
C	7715975		KIT, HARDWARE, WASHERS	
E	7715977		KIT, HARDWARE, WIRE CLAMPS	

PL 5.9. Punch Module- AC Motor

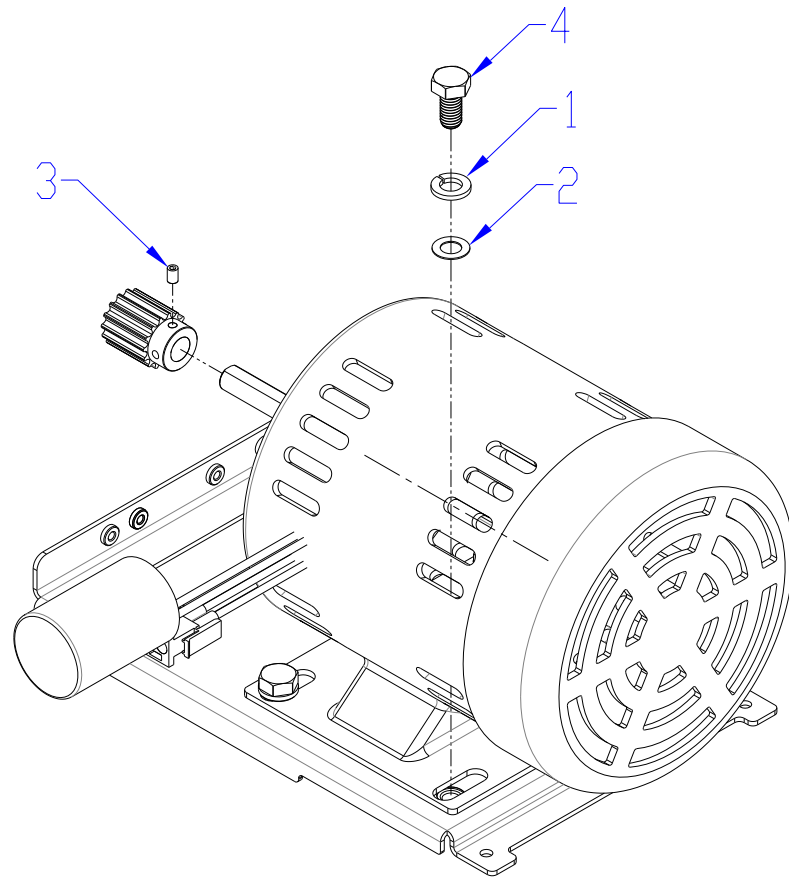

ITEM	GBC Part #		DESCRIPTION	QTY
1	1821807 ^C		WASHER, SPLIT LOCK, M8	4
2	1822113 ^C		WASHER, FLAT, 8X14X0.5	4
3	1823602 ^B		SET SCREW, NYLON PATCH, M4X6	1
4	1824703 ^B		SCREW, HEX CAP, M8, 16MM LONG	4
5	7715860	115V	MOTOR AND PULLEY, PUNCH, 115V, SERVICE (INCLUDES CAPACITOR)	1
	7715861	230V	MOTOR AND PULLEY, PUNCH, 230V, SERVICE (INCLUDES CAPACITOR)	1
B	7715974		KIT, HARDWARE, FASTENERS	
C	7715975		KIT, HARDWARE, WASHERS	

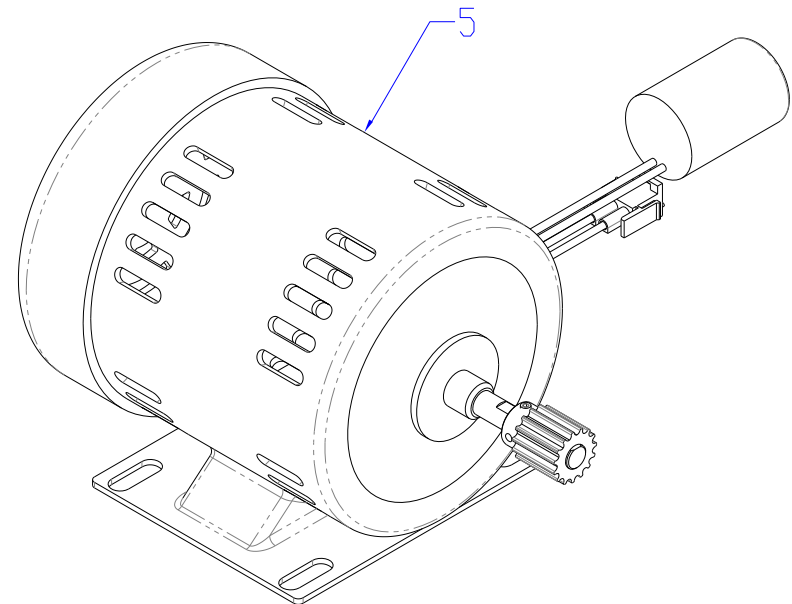

Die Sets

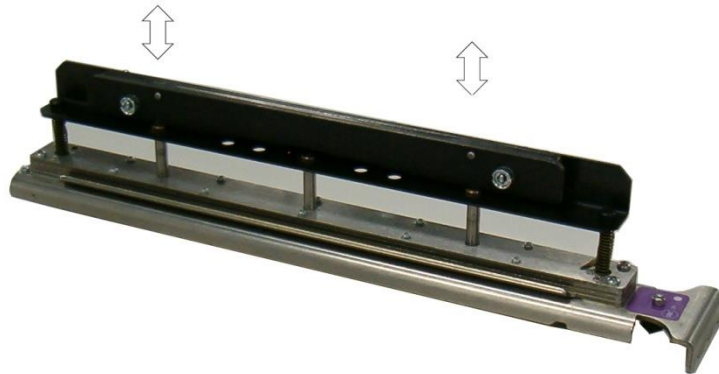

FB Product code	Part Number	DESCRIPTION	ACCO SKU number
CWAA1100	097S 50308	DIE, FujiFilm, CombBind	WSM7724721
CWAA1101	097S 50309	DIE, FujiFilm, Coil, Rnd.	WSM7724715
CWAA1102	097S 50310	DIE , FujiFilm, Wire, 2:1, Rnd.	WSM7724716
CWAA1103	097S 50311	DIE , FujiFilm, Wire, 3:1, Rnd.	WSM7724717
CWAA1104	097S 50312	DIE , FujiFilm, Wire 2:1, Sq.	WSM7724722
CWAA1105	097S 50313	DIE , FujiFilm, Wire 3:1, Sq.	WSM7724723
CWAA1106	097S 50314	DIE , FujiFilm, 4 Hole, 8mm	WSM7724718
CWAA1107	097S 50315	Die, FujiFilm, 3 Hole, 8mm	WSM7724727
CWAA1108	097S 50316	Die, FujiFilm, 3/5/7 Hole, 8mm	WSM7724728
CWAA1109	097S 50317	DIE, FujiFilm, 4 Hole, 6.5mm	WSM7724719
CWAA1110	097S 50318	DIE, FujiFilm, 4 Hole, Scan.	WSM7724720
CWAA1111	097S 50319	Die, FujiFilm, Velobind®, 12 Holes, A4	WSM7724729

Electronics

PL 6.1. Electronics PCB Assembly

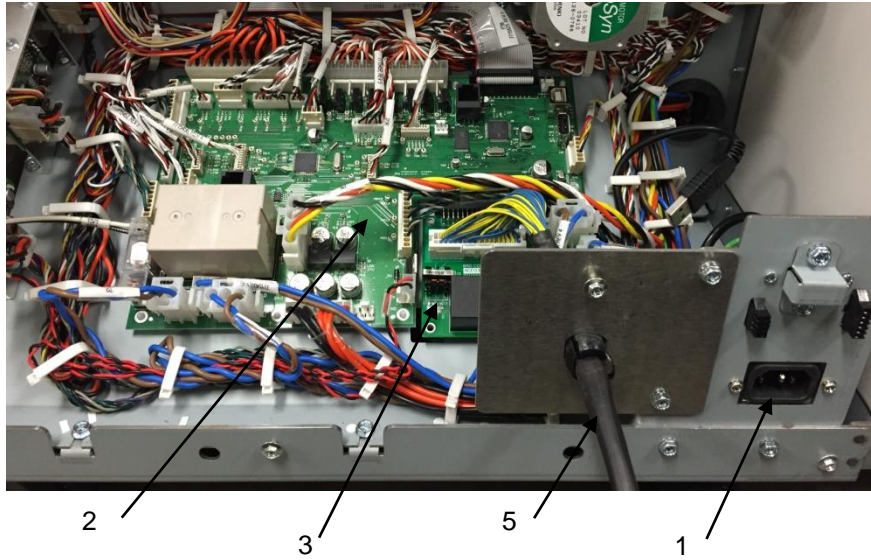

ITEM	GBC Part #	DESCRIPTION	QTY
1	6195001	RFI POWER FILTER	1
2	7718686	BOARD, CONTROL 2, MAIN	1
3	7718684	BOARD, CONTROL, COMM	1
4	7715863	FUSE,AC POWER, 250V, 5A	1
5	7715548	COMMUNICATION CABLE ASSY	1

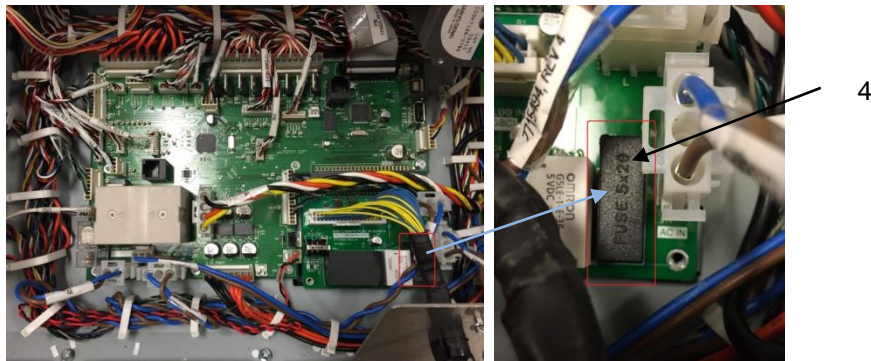

PL 6.2. Control Board Bracket Sub Assembly

ITEM	GBC Part #	DESCRIPTION	QTY
1	1823901 ^B	SCREW, PHILLIPS HX HD W/SEMS, M3X6	1
2	7715817 ^E	WIRE SADDLE, SMALL, LOCKING TOP	4
3	7715818 ^E	WIRE SADDLE, MEDIUM, LOCKING TOP	13
4	7715819 ^E	WIRE SADDLE, LARGE, LOCKING TOP	9
B	7715974	KIT, HARDWARE, FASTENERS	
E	7715977	KIT, HARDWARE, WIRE CLAMPS	

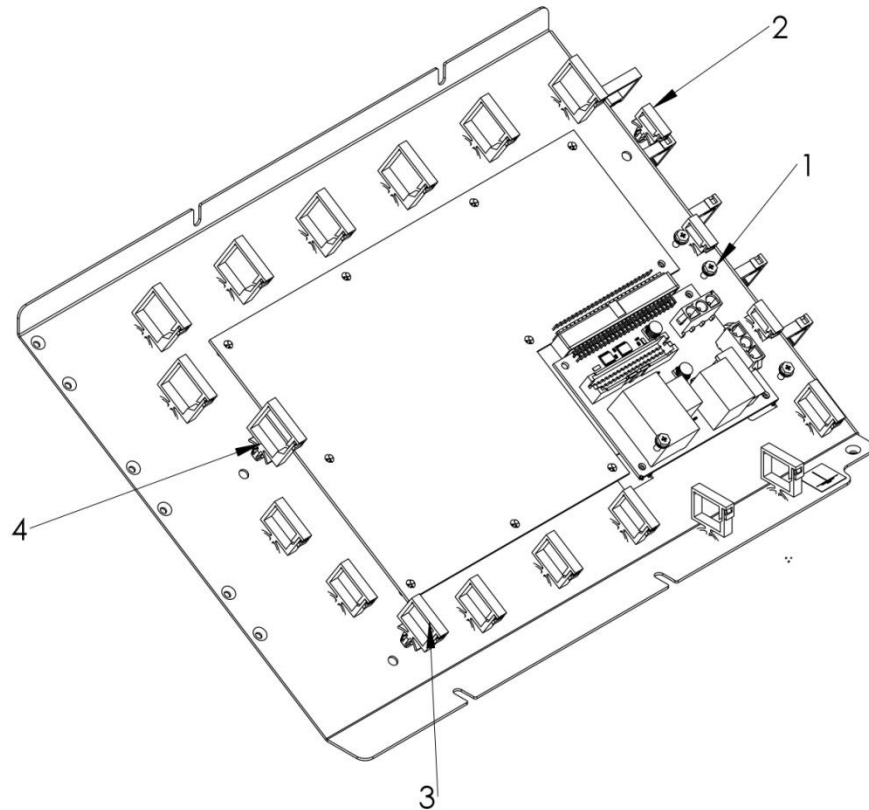

PL 6.3. Cable Part Number Index

Refer to the Wiring drawing on the next page to locate the cables

GBC Part #	DESCRIPTION
7715451	CABLE, SENSORS S1,S25, S26
7715453	CABLE, SENSORS, ENTRY
7715459	CABLE, SENSORS, EXIT
7715466	CABLE, SOLENOIDS, ENTRY, BRD TO HDR
7715467	CABLE, SOLENOIDS, EXIT, BRD TO HDR
7715468	CABLE, ENTRANCE & ACCEL, DRIVER
7715470	CABLE, ALIGN & STEERING DRIVER
7715473	CABLE, EXIT, DECEL & BYPASS DRIVER
7715476	CABLE, PUNCH MOTOR
7715477	CABLE, POWER, STEPPER DRIVERS
7715485	CABLE, CHIP TRAY
7715487	CABLE, DOOR INTERLOCK
7715490	CABLE, USB
7715492	CABLE, DC POWER
7715493	CABLE, AC TO PSU
7715494	CABLE, AC TO BOARD
7715495	CABLE, DIE SET RECOGNITION
7715498	CABLE, AC FILTER TO AC REMOTE
7715508	CABLE, SKEW, HDR TO SENSOR
7715509	CABLE, ALIGN, HDR TO SENSOR
7715510	CABLE, BG, HDR TO SENSOR
7715523	CABLE, LCD
7715525	CABLE, AC FILTER, GROUND
7715548	CABLE ASSY, COMMUNICATION
7715528	CABLE, STEERING MOTOR, MTR TO HDR, FRONT
7715529	CABLE, STEERING, MOTOR, MTR TO HDR, REAR

GBC Part #	DESCRIPTION
7715455	CABLE, SENSORS, SKEW, BRD TO HDR
7715456	CABLE, SENSORS, ALIGN, BRD TO HDR
7715457	CABLE, SENSORS, BG & ALGN HM, BRD TO HDR
7715458	CABLE, SENSORS, MID BG L & XL
7715519	CABLE, ALIGN HOME, HDR TO SENSOR
7715520	CABLE, LEFT STEER, DRV TO HDR
7715521	CABLE, RIGHT STEER, DRV TO HDR
7715538	CABLE, COMM TO PANEL

PL 6.4. Wiring Drawing- OEM Configurations

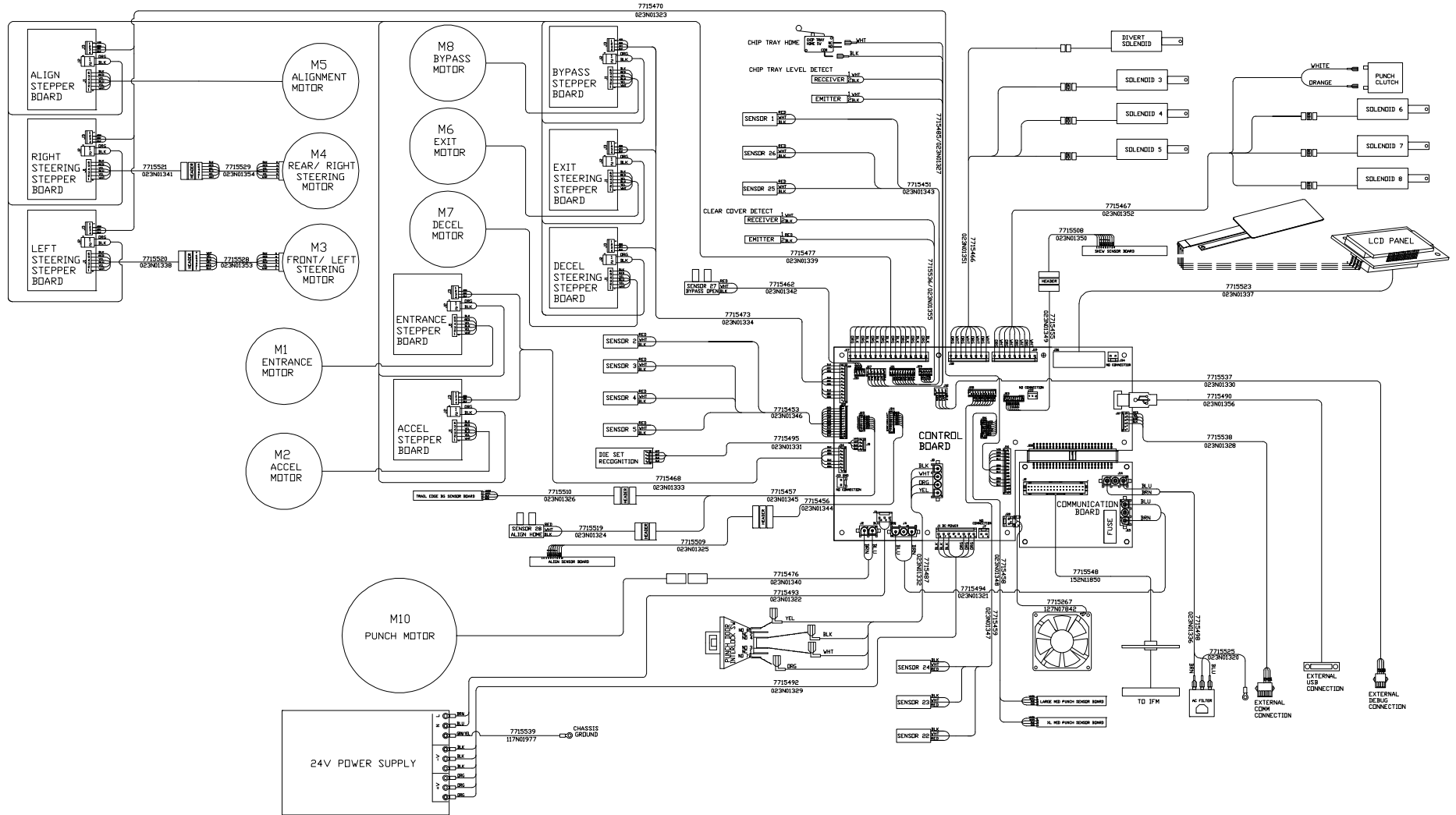

Installation Kit Parts

ITEM	GBC Part #	Xerox Part #		DESCRIPTION	QTY
2	7714332	117N01974	230V	POWER CORD, CONTINENTAL, EUROPE, RIGHT ANGLED	1
3	7714333	117N01975	230V	POWER CORD, UK, RIGHT ANGLED	1
4	7714334	117N01976	230V	POWER CORD, SWISS, RIGHT ANGLED	1
6	7715897	117N01999	230V	POWER CORD, DANISH, RIGHT ANGLED	1
7	7712583	070N00055		OIL, CAN	1
8	7712461	015N00666		PLATE, DOCKING ASSY	1
9	6200015	117N02199	230V	POWER CORD, SWITZERLAND	1
10	6200014	117N02200	230V	POWER CORD, UK, RIGHT ANGLED IEC CONNECTOR	1
11	6200002	117N02201	230V	POWER CORD, CONTINENTAL EUROPE	1

Hardware Kits

ITEM	GBC Part #	DESCRIPTION
1	7715973	KIT, HARDWARE, RINGS
2	7715974	KIT, HARDWARE, FASTENERS
3	7715975	KIT, HARDWARE, WASHERS
4	7715976	KIT, HARDWARE, BEARINGS
5	7715977	KIT, HARDWARE, WIRE CLAMPS
6	7715978	KIT, HARDWARE, SPRINGS

Optional Kits

ITEM	GBC Part #	DESCRIPTION
1	7715864	KIT, CDI RACEWAY
2	7715957	BRACKET, EXIT GUIDE, ANGLED

6. General Procedures and Information

Section Contents

	Page		
General Procedures	6-3	GP 6.2.16	FIRMWARE UPGRADE Procedure 6-49
User Interface	6-3	GP 6.3	Undock the Punch (Moving the punch to Service position) 6-51
Settings.....	6-4	GP 6.4	Dock the punch (Moving the punch to Operating position) 6-52
Information.....	6-4	GP 6.5	Operational Inspection 6-53
User Interface Screen Map	6-5	GP 6.6	Internal Inspection..... 6-53
GP 6.1 User Interface Procedure.....	6-6	GP 6.7	Die Set Service 6-54
GP 6.1.1 BACKGAGE MODE Procedure	6-6	GP 6.7.1	Die Set Life Expectancy 6-54
GP 6.1.2 PUNCH MODE Procedure.....	6-9	GP 6.7.2	Die Set Components 6-54
GP 6.1.3 ALIGNMENT MODE Procedure	6-11	GP 6.7.3	Die Set Lubrication 6-55
GP 6.1.4 TAB/COVER MODE Procedure.....	6-13	GP 6.7.4	Die Set Shoulder Bolts..... 6-56
GP 6.1.5 CLEAR COVER Procedure	6-15	GP 6.8	External Cleaning..... 6-57
GP 6.1.6 LANGUAGE MODE Procedure	6-17	GP 6.9	Internal Cleaning..... 6-57
GP 6.1.7 UNITS MODE Procedure.....	6-18	GP 6.10	Base Cleaning..... 6-58
GP 6.1.8 PAPER SIZE Procedure	6-19	GP 6.11	Chip Bin Cleaning 6-58
GP 6.1.9 DIE TYPE Procedure	6-20	GP 6.12	Die Guide Cleaning 6-59
GP 6.1.10 DIE CYCLES Procedure.....	6-21	GP 6.13	Door Latch Inspection 6-59
GP 6.1.11 PUNCH CYCLES Procedure	6-22	GP 6.14	Idler Roller and Idler Springs Inspection 6-60
GP 6.1.12 FIRMWARE Procedure.....	6-23	GP 6.14.1	Idler Roller Cleaning..... 6-61
Service User Interface	6-24	GP 6.14.2	Steering Idler Roller and Springs Inspection and Cleaning 6-62
Service Interface Screen Map	6-26	GP 6.15	Drive Roller and Steering Drive Roller Inspection and Cleaning 6-63
GP 6.2 Service User Interface Procedure.....	6-27	GP 6.16	Panel Latch Inspection..... 6-64
GP 6.2.1 SPEED ADJUST Procedure	6-28	GP 6.17	Optical Sensor Cleaning 6-67
GP 6.2.2 PAPER SIZE Procedure	6-30	GP 6.18	Bypass Paper Path Inspection and Cleaning... 6-68
GP 6.2.3 MAX BYPASS Setting.....	6-31	GP 6.19	Punch Paper Path Inspection and Cleaning ... 6-69
GP 6.2.4 RUN MODE Setting	6-32	GP 6.20	Punch Drive Cam Lubrication 6-70
GP 6.2.5 DIE CYCLES.....	6-33	GP 6.21	Timing Belt Inspection..... 6-71
GP 6.2.6 SENSORS Procedure.....	6-34	GP 6.22	Solenoid Cleaning and Inspection 6-72
GP 6.2.7 I/O SIGNALS Procedure.....	6-36	GP 6.23	Alignment Carriage Rails Cleaning 6-73
GP 6.2.8 DFA STATUS Procedure.....	6-37	GP 6.24	Punch Clutch Inspection and Cleaning 6-74
GP 6.2.9 SOLENOIDS Procedure	6-38	GP 6.25	Diverter Solenoid Assembly Inspection 6-75
GP 6.2.10 SOLENOIDS Procedure	6-38		
GP 6.2.11 MOTORS Procedure.....	6-39		
GP 6.2.12 FUNCTION TESTS Procedure (Cycle Punch, Aligner Test, Fan Test).....	6-40		
GP 6.2.13 SKEW OFFSETS Procedure	6-42		
GP 6.2.14 ALIGN OFFSETS Procedure.....	6-46		
GP 6.2.15 LOG.....	6-48		

GP 6.26	Die Set Recognition Board Clips Inspection	6-75
GP 6.27	Die Lock Mechanism and Die Rail Springs Inspection	6-76
General Information	6-77
	Principle of Operation.....	6-77
	Punch Path.....	6-77
	Single Punch	6-77
	Double Punch (Mid punch + trail edge punch).....	6-78
	Bypass Path	6-78
	Glossary of Terms	6-80
	Die Sets	6-81

	Die Sets List.....	6-82
	Die Sets List (cont'd).....	6-83
Tools	6-84
	Standard Tools (metric)	6-84
	Other Recommended Tools and Supplies.....	6-84
Lubrication	6-84
Cleaning Materials	6-85
Serial Numbers	6-86

General Procedures

User Interface



The User Interface consists of an LCD screen, an Up Arrow button, a Down Arrow button and an Enter Button.

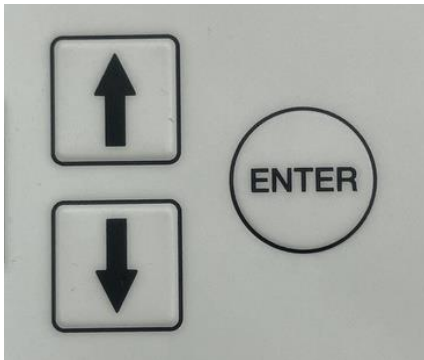

The buttons on the User Interface allow you to change the punch mode, the Backgauge, alignment, language, and the units.

The User Interface displays status messages and fault codes on two rows of text.

READY
SINGLE PUNCH

In the User Interface, the top row of text displays the status of the Punch (Ready, Close Door). The bottom row of text displays the options selected on the User Interface (Single Punch).

To change the settings on the User Interface:

1. From the top level screen, press either the up arrow button or the down arrow button then press the ENTER button to display the SETTINGS/ INFORMATION screen.

SETTINGS	↙	↑
INFORMATION		↓

- The up arrow indicates that there is a menu option above the option displayed.
 - The down arrow indicates that there is a menu option below the option displayed.
 - The return symbol indicates the option that will open when you press the ENTER button.
2. To select **SETTINGS**, press the ENTER button when the return symbol is next to the word Settings.
 3. To select **INFORMATION**, press the down arrow button to move the return symbol down until it is next to the word Information, then press the ENTER button.

Settings

Backgage

The Backgage feature allows you to scroll up or down to change the backgage setting.

Alignment

The Alignment feature allows you to scroll up or down to change the alignment setting.

You can change the alignment of the paper passing through the punch inboard and outboard ± 2.0 mm.

Tab/Cover

The Tab /Cover feature enables the system to .

Clear Cover

The Clear Offset feature allows you to set the Backgage and Alignment for only Clear Cover media. This setting does not affect other plain media.

Language

The Language feature allows you to select the language for the user interface. The language options are: English, Francais, Espanol, Deutsch, and Italiano.

Units

The Units feature allows you to select the units displayed on the user interface. Select MM for millimeters of IN for inches.

Paper Size

This is used the set the machine for running US (ANSI) paper sizes or ISO paper sizes.

Information

The User Interface allows you to view information about. Die Type, Die Cycles, Punch Cycles, and Firmware

Die Type

The Die Type feature identifies the type of Die Set installed to the FuturoPunch Pro.

Die Cycles

The Die Cycles feature lists the number of cycles on the Die Set installed to the FuturoPunch Pro.

Punch Cycles

The Punch Cycles feature lists the number of punch cycles completed by the Punch.

Firmware

The Firmware feature identifies the level of the firmware installed to the FuturoPunch Pro.

User Interface Screen Map

LCD User Interface Screen Overview

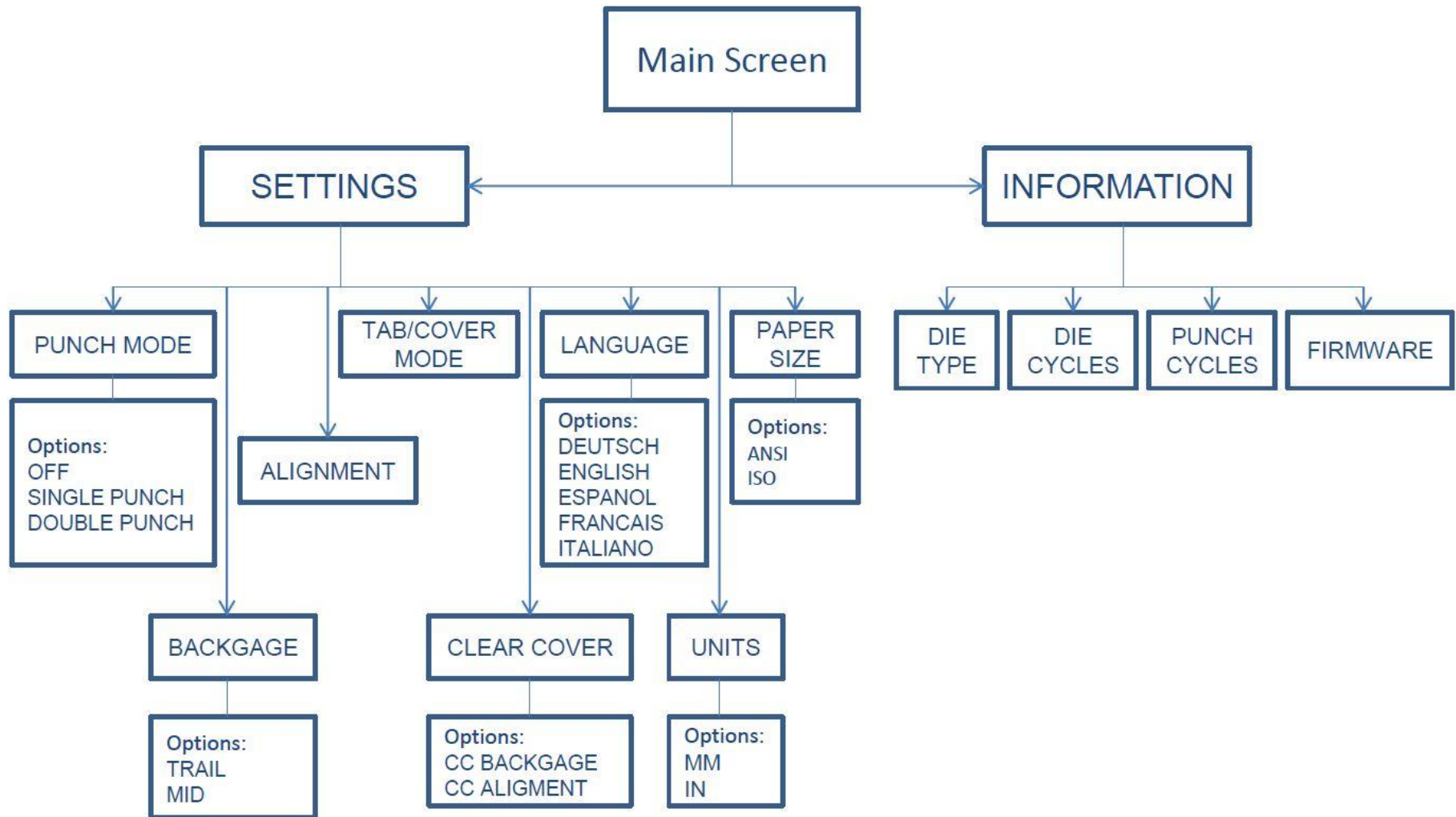

GP 6.1 User Interface Procedure

Use the following procedures to change the settings and view the Information on the User Interface

GP 6.1.1 BACKGAGE MODE Procedure

Do the following to change the Backgagage (move the position of the punch holes toward or away from the trail edge of the paper).

1. From the top level screen, press either the up arrow button or the down arrow button.

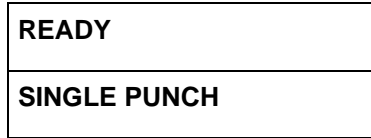

This displays the SETTINGS - INFORMATION screen

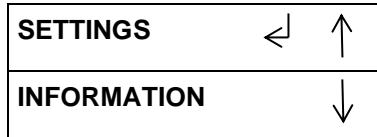

1. Press the ENTER button when the return symbol is next to SETTINGS to display the BACKGAGE/ALIGNMENT screen.
Press the ENTER button when the return symbol is next to the word BACKGAGE to display TRAIL / MID screen.

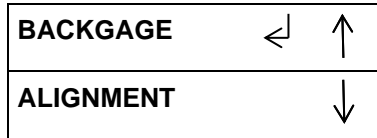

2. Press the ENTER button when the return symbol is next to the word Backgagage. to display the TRAIL MID screen.

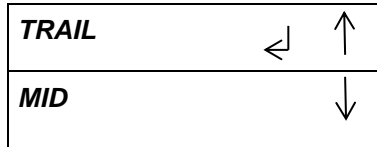

- TRAIL refers to the trail edge punch (Single Punch) and MID refers to the punch happening MID sheet (Double Punch).
- For TRAIL Backgagage go to step 5.
- MID Backgagage function is limited to *DFA Configuration*

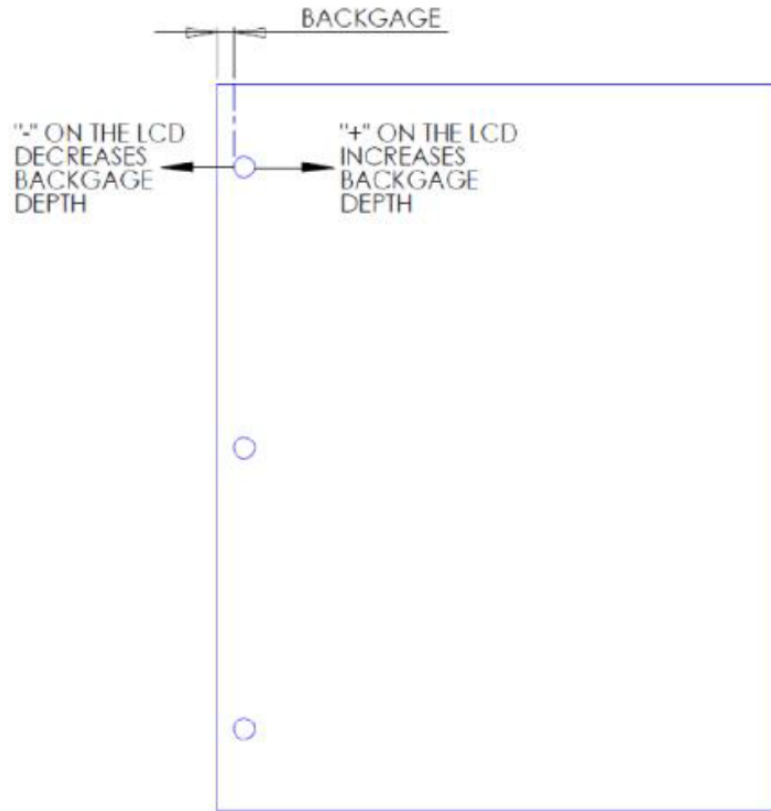

3. Do steps 4 - 12 to use TRAIL to adjust the Backgagage for a Single Punch job:

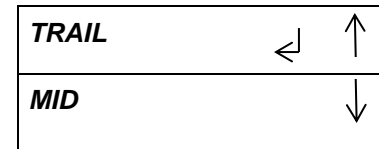

4. Press the ENTER button when the return symbol is next to the word TRAIL to select Trail Backgagage.
5. This displays the TRAIL OFFSET screen.



6. Press the up arrow button or the down arrow button to change the offset by ± 0.01 in (or 0.1 mm).

TRAIL OFFSET	
0.01 in	↵

- A + offset moves the position of the punch holes away from the trail edge of the paper (increases the Backgage depth).
 - A - offset moves the position of the punch holes toward the trail edge of the paper (decreases the Backgage depth).
 - The maximum Backgage change is + 10.4mm and - 5.4mm.
7. Press the ENTER button to enter the new Backgage value.
This displays the TRAIL / MID screen.

TRAIL	↵	↑
MID		↓

8. Press the up arrow button to display the PREVIOUS MENU option.

PREVIOUS MENU	↑
TRAIL	↓

9. Press the up arrow button to display the EXIT option.

EXIT	↵	↑
PREVIOUS MENU		↓

10. Press the ENTER button to display the SAVE VALUES screen.

SAVE VALUE?	
YES	↵ NO

- To select YES, press the ENTER button.
- To select NO, press the down arrow button, to move the return symbol. Then press the ENTER button.

This displays the top level screen.

READY
SINGLE PUNCH

NOTE: The BACKGAGE feature has the option to save as it defines the backgage for that particular die type. This means that for any die of that type inserted into that machine, the saved backgage will apply. If the user does not save the new backgage, the next time a die of this type is inserted the machine it will revert to the default depth for that die.

11. Do steps 12 - 19 to adjust the Backgauge of the MID sheet punch for a Double Punch job- *for DFA configurations only.*

TRAIL	↵	↑
MID		↓

12. Press either the up arrow button or the down arrow button until the return symbol is next to the word MID.

TRAIL		↑
MID	↵	↓

13. Press the ENTER button when the return symbol is next to the word MID. to select Mid Backgage. This displays the MID OFFSET screen.

MID OFFSET	
0.00 in	↵

14. Press the up arrow button or the down arrow button to change the offset by ± 0.01 in (or 0.01 mm).

MID OFFSET	
0.01 in	↵

- A + offset moves the position of the punch holes away from the trail edge of the paper (increases the Backgage depth).

- A - offset moves the position of the punch holes toward the trail edge of the paper (decreases the Backgauge depth).
- The maximum Backgauge change is + 10.4mm and - 5.4mm.

15. Press the ENTER button to enter the new Backgauge value.

This displays the MID / PREVIOUS MENU screen.

MID	↩	↑
PREVIOUS MENU		↓

16. Press the ENTER button to display the SAVE VALUES screen.

SAVE VALUE?
YES ↩ NO

- To select YES, press the ENTER button.
- To select NO, press the down arrow button, to move the bent arrow. Then press the ENTER button.

17. This displays the BACKGAUGE / ALIGNMENT screen.

BACKGAGE	↩	↑
ALIGNMENT		↓

NOTE: The BACKGAGE feature has the option to save as it defines the backgauge for that particular die type. This means that for any die of that type inserted into that machine, the saved backgauge will apply. If the user does not save the new backgauge, the next time a die of this type is inserted the machine it will revert to the default depth for that die.

GP 6.1.2 PUNCH MODE Procedure

Do the following to select the desired Punch Mode option. There are three Punch Mode options" OFF, SINGLE PUNCH, and DOUBLE PUNCH.

1. From the top level screen, press either the up arrow button or the down arrow button.

READY
SINGLE PUNCH

This displays the SETTINGS - INFORMATION screen

SETTINGS	←	↑
INFORMATION		↓

2. Press the ENTER button when the return symbol is next to the word SETTINGS. To display the display the PUNCH MODE/ BACKGAUGE screen.

PUNCH MODE	←	↑
BACKGAGE		↓

3. Press the ENTER button to display the Punch Mode menu.

PUNCH MODE		↑
SINGLE PUNCH	←	↓

Note: SINGLE PUNCH is the default.

4. To Select Single Punch mode:

- If necessary, press the up or down arrow button to display SINGLE PUNCH.

PUNCH MODE		↑
SINGLE PUNCH	←	↓

- When the return symbol is next to the word Single Punch, press the ENTER button to select Single Punch.

PUNCH MODE	←	↑
BACKGAGE		↓

5. To Select Double Punch mode:

- Press the up or down arrow button to display DOUBLE PUNCH.

PUNCH MODE		↑
DOUBLE PUNCH	←	↓

- When the return symbol is next to the word Double Punch, press the ENTER button to select Double Punch.

PUNCH MODE	←	↑
BACKGAGE		↓

(Cont.)

6. To select Bypass Mode (OFF), press the up or down arrow button until the return symbol is next to the word OFF.

PUNCH MODE	↑
OFF	↵ ↓

7. Press the ENTER button to select OFF. This will enable Bypass mode.

PUNCH MODE	↵ ↑
BACKGAGE	↓

8. Press the up arrow button to display the PREVIOUS MENU option.

PREVIOUS MENU	↑
PUNCH MODE	↓

9. Press the up arrow button to display the EXIT option.

EXIT	↵ ↑
PREVIOUS MENU	↓

10. Press the ENTER button to return to the top level screen

READY
DOUBLE PUNCH

GP 6.1.3 ALIGNMENT MODE Procedure

Do the following to change the Alignment (move the inboard/outboard position of the punch holes). This setting applies to all paper sizes

- From the top level screen, press either the up arrow button or the down arrow button.

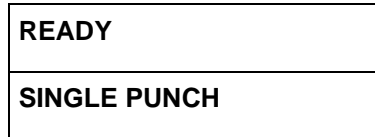

This displays the SETTINGS - INFORMATION screen

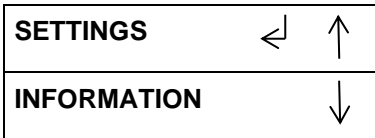

- Press the ENTER button when the return symbol is next to the word SETTINGS. To display the display the BACKGAGE/ ALIGNMENT screen.

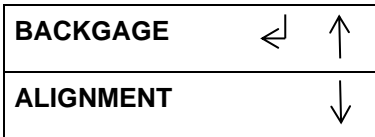

- Press the down arrow button once so the return symbol is next to the word ALIGNMENT.

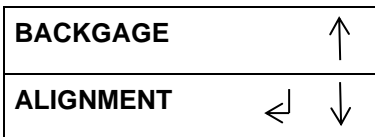

- Press the ENTER button when the return symbol is next to the word Alignment to display the ALIGNMENT OFFSET screen.

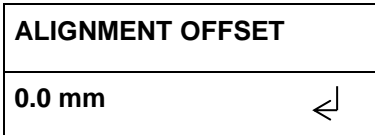

- Press the up arrow button or the down arrow button to change the offset by ± 0.1 mm (screen will display in inch if UNITS are chosen as INCH)

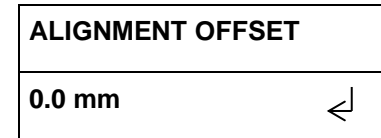

- A + offset moves the position of the punch holes toward the rear of the machine (shallower).
- A - offset moves the position of the punch holes toward the front of the machine (deeper)..

The maximum alignment change is ± 2.0 mm

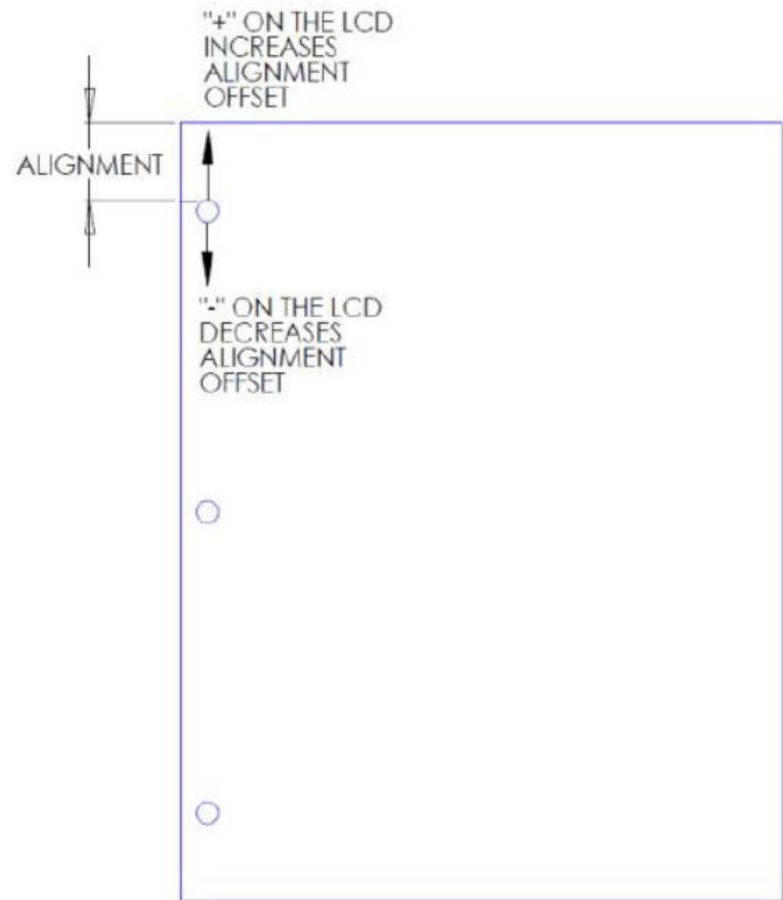

6. Press the ENTER button to input the new Alignment value, and display the ALIGNMENT / TAB COVER MODE screen.

ALIGNMENT	↵	↑
TAB/COVER MODE		↓

7. Press the up arrow button four times to display the EXIT option.

EXIT	↵	↑
PREVIOUS MENU		↓

8. Press the ENTER button to return to the top level screen.

READY
SINGLE PUNCH

GP 6.1.4 TAB/COVER MODE Procedure

Do the following to select the TAB/COVER mode. This options enables you to distinguish between sheets that have equal width, but unequal lengths.

1. From the top level screen, press either the up arrow button or the down arrow button.

READY
SINGLE PUNCH

This displays the SETTINGS - INFORMATION screen

SETTINGS	←	↑
INFORMATION		↓

2. Press the ENTER button when the return symbol is next to the word SETTINGS.
3. Press the down arrow button until the return symbol is next to the word TAB/COVER MODE.

ALIGNMENT		↑
TAB/COVER	←	↓

4. Press the ENTER button when the return symbol is next to the word TAB/COVER. to display the TAB/COVER screen.

If PAPER SIZE selected is ISO:

225mm WIDE?
TAB/COVER MODE ←

If PAPER SIZE selected is ANSI:

9" WIDE?
TAB/COVER MODE ←

The options are:

- TAB / COVER
 - SRA4(if PAPER SIZE is ISO); 9x12 (if PAPER SIZE is ANSI)
5. Press either the up arrow button or the down arrow button to change Tab/Cover setting.

If PAPER SIZE is set to ISO:

If the 225mm wide sheet is a Tab/Cover, select Tab/Cover (Width of A4 tab sheet is 225mm; some covers are 225mm wide and 297mm long)

If the 225mm wide sheet is SRA4 size, select SRA4.

225mm WIDE?
TAB/COVER ←

225mm WIDE?
SRA4 ←

If PAPER SIZE is set to ANSI:

If the 9" wide sheet is a Tab/Cover, select Tab/Cover (Width of LTR tab sheet is 9"; some covers are 9" wide and 11" long)

If the 9" wide sheet is 9"x12" size, select 9x12.

9" WIDE?
TAB/COVER ←

9" WIDE?
9x12 ←

6. Press the ENTER button to input the new Tab/Cover setting and display the TAB/COVER MODE / CLEAR OFFSETS screen.

TAB/COVER MODE	↵	↑
TAB/COVER MODE		↓

7. Press the up arrow button to display the EXIT option.

EXIT	↵	↑
PREVIOUS MENU		↓

- Press the ENTER button to return to the top level screen

READY
SINGLE PUNCH

GP 6.1.5 CLEAR COVER Procedure

Do the following to adjust the Backgauge and Alignment position of Clear Cover media only. This setting does not affect the Backgauge and Alignment of other plain media.

1. From the top level screen, press either the up arrow button or the down arrow button.

READY	
SINGLE PUNCH	

This displays the SETTINGS - INFORMATION screen

SETTINGS	← ↑
INFORMATION	↓

2. Press the ENTER button when the return symbol is next to the word SETTINGS. Press the down arrow button until the return symbol is next to the word CLEAR OFFSET.

TAB/COVER MODE	↑
CLEAR COVER	← ↓

3. Press the ENTER button when the return symbol is next to the word CLEAR OFFSET to display the CLEAR OFFSET screen.

CC BACKGAGE	← ↑
CC ALIGNMENT	↓

- For CC BACKGAUGE go to step 4.
- For CC ALIGNMENT go to step 7 (See page 6-16).

4. To adjust the BACKGAGE values, press the ENTER button when the return symbol is next to the words CC BACKGAUGE,

CC BACKGAGE	← ↑
CC ALIGNMENT	↓

This displays the CC BACKGAUGE screen

CC BACKGAGE	←
0.00 in	

You can adjust the Backgauge position of the Clear Cover media using the up/down arrow buttons. See GP 6.1.1 BACKGAGE PROCEDURE for more details.

5. Press the ENTER button to display the CC BACKGAGE / CC ALIGNMENT screen.

CC BACKGAGE	← ↑
CC ALIGNMENT	↓

6. Press the up arrow button to display the EXIT option.

EXIT	← ↑
PREVIOUS MENU	↓

- Press the ENTER button to return to the top level screen

READY	
SINGLE PUNCH	

(Cont.)

7. To adjust the ALIGNMENT values, press the down arrow button until the return symbol is next to the words CC ALIGNMENT,

CC BACKGAGE	↵	↑
CC ALIGNMENT		↓

8. To adjust the ALIGNMENT values, press the ENTER button when the return symbol is next to the words CC ALIGNMENT,

CC BACKGAGE		↑
CC ALIGNMENT	↵	↓

This displays the CC ALIGNMENT screen

CC ALIGNMENT	↵
0.000 in	

You can adjust the Alignment position of the Clear Cover media using the up/down arrow buttons. See GP 6.1.2 ALIGNMENT PROCEDURE for more details.

9. Press the ENTER button to display the CC ALIGNMENT / PREVIOUS MENU screen.

CC ALIGNMENT	↵	↑
PREVIOUS MENU		↓

10. Press the ENTER button to display the CLEAR COVER / LANGUAGE screen.

CLEAR COVER	↵	↑
LANGUAGE		↓

11. Press the up arrow button to display the EXIT option.

EXIT	↵	↑
PREVIOUS MENU		↓

12. Press the ENTER button to return to the top level screen

READY
SINGLE PUNCH

GP 6.1.6 LANGUAGE MODE Procedure

Do the following to select the Language mode.

1. From the top level screen, press either the up arrow button or the down arrow button.

READY
SINGLE PUNCH

This displays the SETTINGS - INFORMATION screen

SETTINGS	←	↑
INFORMATION		↓

2. Press the ENTER button when the return symbol is next to the word SETTINGS. Press the down arrow button so the return symbol is next to the word Language.

CLEAR COVER		↑
LANGUAGE	←	↓

3. Press the ENTER button when the return symbol is next to the word Language. to display the LANGUAGE screen.

LANGUAGE	
ENGLISH	←

4. Press either the up arrow button or the down arrow button to change language.

LANGUAGE	
ESPAÑOL	←

- English
- Espanol
- Francais
- Italiano
- Deutsch

5. Press the ENTER button to input the new language value, and display the Language / Units screen.

LANGUAGE	←	↑
UNITS		↓

6. Press the up arrow button to display the EXIT option.

EXIT	←	↑
PREVIOUS MENU		↓

7. Press the ENTER button to return to the top level screen

READY
SINGLE PUNCH

GP 6.1.7 UNITS MODE Procedure

Do the following to select the Units mode- MM or INCHES.

1. From the top level screen, press either the up arrow button or the down arrow button.

READY
SINGLE PUNCH

This displays the SETTINGS - INFORMATION screen

SETTINGS	↵	↑
INFORMATION		↓

2. Press the ENTER button when the return symbol is next to the word SETTINGS. Press the down arrow button so the return symbol is next to the word Units.

LANGUAGE		↑
UNITS	↵	↓

3. Press the ENTER button when the return symbol is next to the word Units to display the UNITS screen.

UNITS	
MILIMETERS	↵

4. Press either the up arrow button or the down arrow button to change units displayed.

UNITS	
INCHES	↵

- Millimeters
- Inches

5. Press the ENTER button to input the value, and display the Units / Previous Menu screen.

UNITS	↵	↑
PREVIOUS MENU		↓

6. Press the down arrow button once to move the return symbol next to the word PREVIOUS MENU.

UNITS		↑
PREVIOUS MENU	↵	↓

7. Press the ENTER button to display the SETTINGS - INFORMATION screen.

SETTINGS	↵	↑
INFORMATION		↓

8. Press the up arrow button to display the EXIT option.

EXIT	↵	↑
PREVIOUS MENU		↓

9. Press the ENTER button to return to the top level screen

READY
SINGLE PUNCH

GP 6.1.8 PAPER SIZE Procedure

Do the following to select ANSI or ISO paper sizes.

1. From the top level screen, press either the up arrow button or the down arrow button.

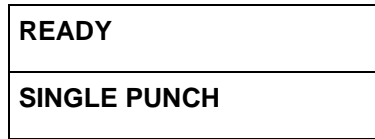

This displays the SETTINGS - INFORMATION screen

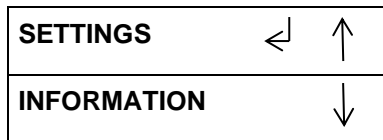

2. Press the ENTER button when the return symbol is next to the word SETTINGS. Press the down arrow button so the return symbol is next to the word Paper Size.

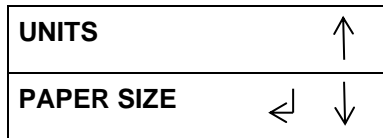

3. Press the ENTER button when the return symbol is next to the word Paper Size to display the Paper Size screen.

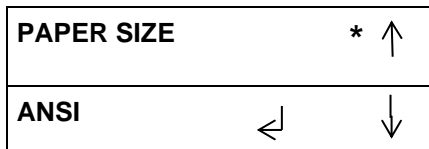

4. Press the down arrow to scroll through the speed options
 - ANSI
 - ISO

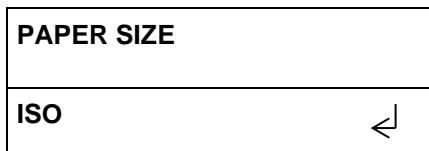

- If you are running LTR/11x17/STMT sizes – set the “Paper Size” setting to ANSI.

- If you are running one of the ISO sizes (A3, A4, A5) set the “Paper Size” setting to ISO.

5. When the return symbol is next to the desired paper size, press the ENTER button to set the paper size and return to the PAPER SIZE / PREVIOUS MENU screen.

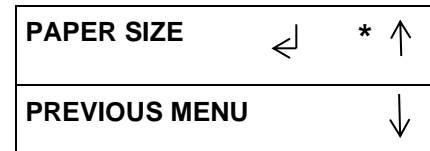

6. Press the up arrow twice to display the EXIT / SPEED (DFA) screen.

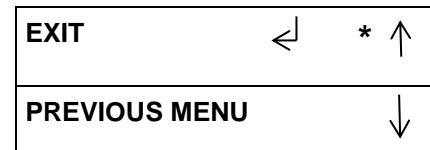

7. Press the ENTER button to return to the top level screen

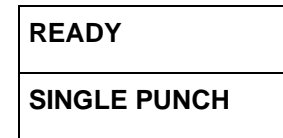

GP 6.1.9 DIE TYPE Procedure

The Die Type feature identifies the type of Die Set installed to the FuturoPunch Pro.

1. From the top level screen,

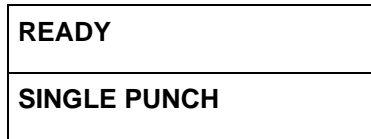

2. Press either the up arrow button or the down arrow button to display the SETTINGS/ INFORMATION screen.

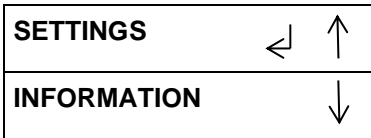

3. Press the down arrow button to move the return symbol down until it is next to the word INFORMATION,

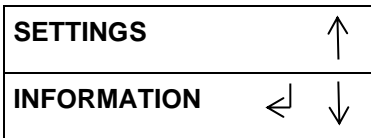

4. Press the ENTER button to display the DIE TYPE – DIE CYCLES screen.

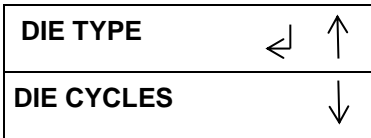

5. Press the ENTER button when the return symbol down is next to the words DIE TYPE.

This displays the DIE TYPE screen,

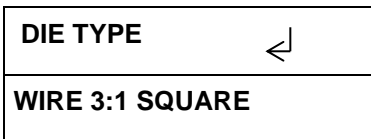

6. Press the ENTER button to return to the DIE TYPE – DIE CYCLES screen.

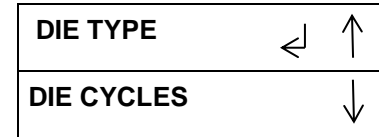

7. Press the up arrow button to display the EXIT option.

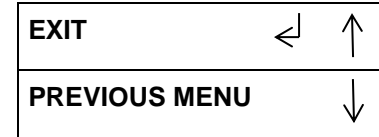

8. Press the ENTER button to return to the top level screen

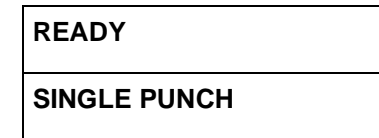

GP 6.1.10 DIE CYCLES Procedure

The Die Cycles feature lists the total number of sheets punched with the Die Set currently installed in the FuturoPunch Pro.

- From the top level screen,

READY
SINGLE PUNCH

- Press either the up arrow button or the down arrow button to display the SETTINGS/ INFORMATION screen.

SETTINGS	↵	↑
INFORMATION		↓

- Press the down arrow button to move the return symbol down until it is next to the word INFORMATION

SETTINGS		↑
INFORMATION	↵	↓

- Press the ENTER button to display the DIE TYPE – DIE CYCLES screen.

DIE TYPE		↑
DIE CYCLES		↓

- Press the down arrow button so the return symbol is next to the words DIE CYCLES.

DIE TYPE		↑
DIE CYCLES	↵	↓

- Press the ENTER button when the return symbol is next to the words Die Cycles. to display the DIE CYCLES screen.

DIE CYCLES	↵
17,129	

- If any of the Die Set life cycles have exceeded 750,000 sheets (cycles) go to Section 3 and check the Hole Quality.

- If the Hole Quality is acceptable monitor the Hole Quality frequently to ensure that the Hole Quality is okay.
- If the Hole Quality is not acceptable replace the Die Set.

- Press the ENTER button to display the DIE TYPE – DIE CYCLES screen.

DIE TYPE		↑
DIE CYCLES	↵	↓

- Press the up arrow button three times to display the EXIT option.

EXIT	↵	↑
PREVIOUS MENU		↓

- Press the ENTER button to return to the top level screen

READY
SINGLE PUNCH

GP 6.1.11 PUNCH CYCLES Procedure

The Punch Cycles feature lists the total number of punch sheets FuturoPunch Pro has processed.

1. From the top level screen,

READY
SINGLE PUNCH

2. Press either the up arrow button or the down arrow button to display the SETTINGS/ INFORMATION screen.

SETTINGS	↵	↑
INFORMATION		↓

3. Press the down arrow button to move the return symbol down until it is next to the word Information,

SETTINGS		↑
INFORMATION	↵	↓

4. Press the ENTER button to display the DIE TYPE – DIE CYCLES screen.

DIE TYPE	↵	↑
DIE CYCLES		↓

5. Press the down arrow button until the return symbol is next to the words the PUNCH CYCLES.

DIE CYCLES		↑
PUNCH CYCLES	↵	↓

6. Press the ENTER button when the return symbol is next to the words PUNCH CYCLES. to display the PUNCH CYCLES screen.

PUNCH CYCLES	↵
23,495	

7. Press the ENTER button to display the DIE CYCLES – PUNCH CYCLES screen.

DIE CYCLES	↑
PUNCH CYCLES	↓

8. Press the up arrow button four times to display the EXIT option.

EXIT	↵	↑
PREVIOUS MENU		↓

9. Press the ENTER button to return to the top level screen

READY
SINGLE PUNCH

GP 6.1.12 FIRMWARE Procedure

The Firmware feature identifies the level of the firmware installed to the FuturoPunch Pro.

1. From the top level screen,

READY
SINGLE PUNCH

2. Press either the up arrow button or the down arrow button to display the SETTINGS/INFORMATION screen.

SETTINGS	↵	↑
INFORMATION		↓

3. Press the down arrow button to move the return symbol down until it is next to the word INFORMATION,

SETTINGS		↑
INFORMATION	↵	↓

4. Press the ENTER button to display the DIE TYPE – DIE CYCLES screen.

DIE TYPE	↵	↑
DIE CYCLES		↓

5. Press the down arrow button three times so the return symbol is next to the word FIRMWARE.

PUNCH CYCLES		↑
FIRMWARE	↵	↓

6. Press the ENTER button when the return symbol is next to the word Firmware to display the FIRMWARE screen.

FIRMWARE		↵
0B.48		B1.20

7. Press the ENTER button to display the PUNCH CYCLES – FIRMWARE screen.

PUNCH CYCLES		↑
FIRMWARE	↵	↓

8. Press the up arrow button five times to display the EXIT option.

INFORMATION		↑
EXIT	↵	↓

9. Press the ENTER button to return to the top level screen

READY
SINGLE PUNCH

Service User Interface

The Service User Interface allows you to:

- Set the Paper Size, Max bypass sheet size, Run Mode, Line speed.
- Check the operation of the Sensors, Solenoids, and the Motors.
- Run the Cycle Punch and Aligner Test routines.
- Set the Skew Offsets, Align offsets
- View Die Cycles.
- Obtain Log file.
- Perform Firmware Upgrade.

When the Service user Interface is open, the top row of text and the bottom row of text display the options on the Service User Interface menu.

Paper Size

The Paper Size feature allows you to select the desired paper size.

- ANSI
- ISO

Max Bypass

The Max Bypass feature allows you to set the maximum sheet length that will be bypassed through FuturoPunch Pro.

Run Mode

The Run Mode feature allows you to select the desired run mode.

- AUTO RUN
- AUTO CYCLE

Die cycles

The Die cycles menu displays the number of punched cycles on the die currently installed.

Sensors

The Sensors feature allows you to view the state of each of the 29 sensors to the FuturoPunch Pro.

- 0 means the sensor is open.
- 1 means the sensor is covered

Press the Up Arrow button and Down Arrow buttons to scroll through the list of sensors.

Solenoids

The Solenoid feature allows you to test the operation of each of the 8 solenoids to the FuturoPunch Pro.

Press the Up Arrow button and Down Arrow buttons to scroll through the list of solenoids.

Motors

The Motors feature allows you to test the operation of each of the 10 motors to the FuturoPunch Pro.

Press the Up Arrow button and Down Arrow buttons to scroll through the list of motors.

Function Tests

The Function Tests feature allows you to run the Cycle Punch and Aligner Test routines.

Press the Up Arrow button and Down Arrow buttons to highlight the desired test.

Press the Enter button to run the test. Press the Enter button again to stop the test.

The **Cycle Punch Test** starts the Punch Motor, waits for 2 seconds, then triggers the Punch at 1 punch per second for 5 cycles.

The **Aligner Test** moves the home Aligner CW 10mm, back to home, CCW 10mm, then back to home. It repeats this cycle 5 times.

The **Fan Test** starts the Exhaust Fan at the rear of the Punch..

Skew Offsets

The Skew Offsets feature allows you to setup the skew offsets to straighten and offset punch depth. The options are:

- BG LEFT
- BG RIGHT
- BG DP L LEFT
- BG DP L RIGHT
- BG DP XL LEFT
- BG DP XL RIGHT

Align Offsets

The Align Offsets feature allows you to setup the align offsets to straighten and offset punch depth.

Log

The LOG file download option will save the information about the last 50 punched sheets to a USB flash drive.

Firmware Update

The Firmware Update feature allows you to update the firmware for the Punch.

Service Interface Screen Map

LCD Service Interface Screen Overview

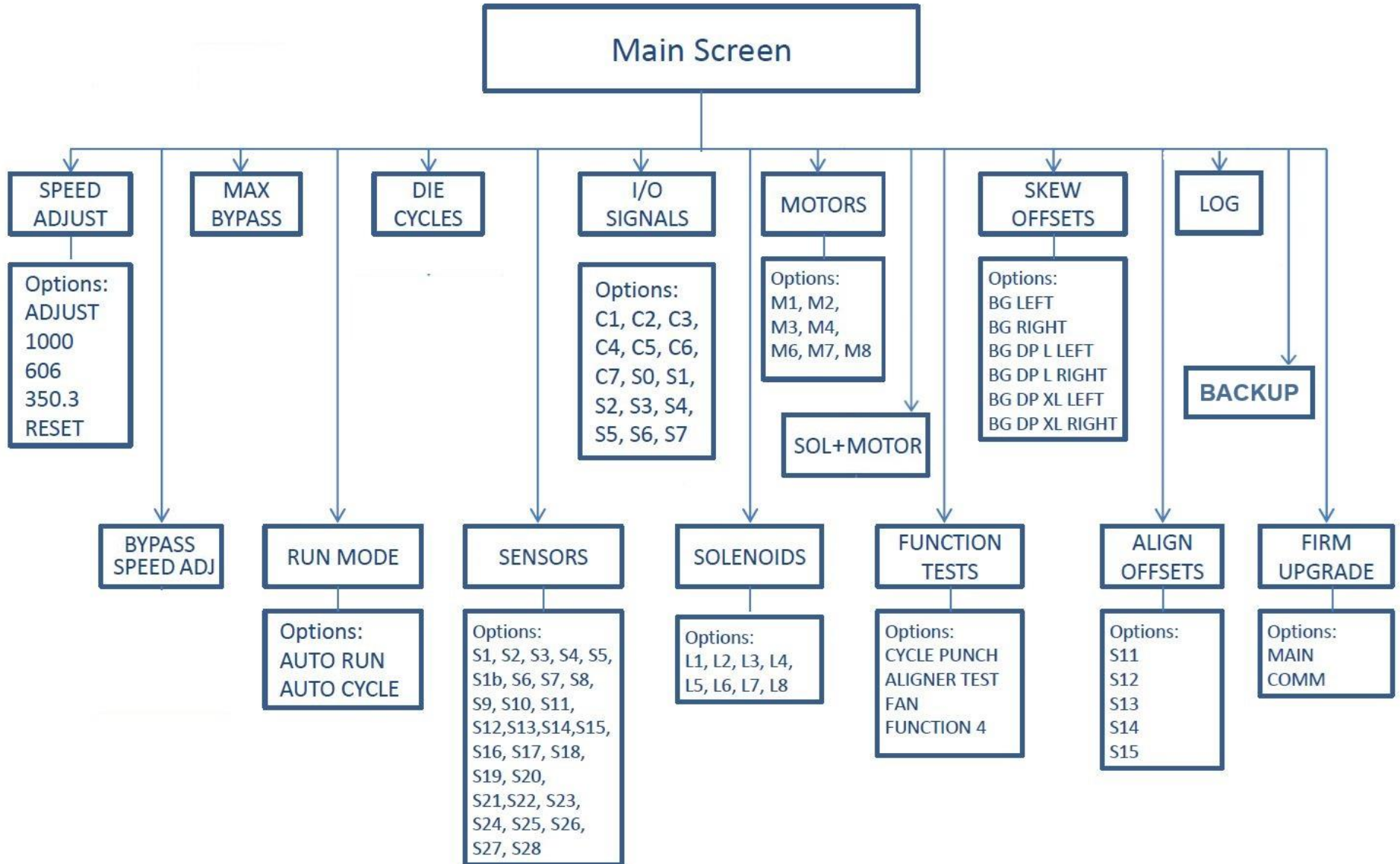

GP 6.2 Service User Interface Procedure

To enter the Service User Interface:

1. Press and hold both the Up Arrow button and the Down Arrow button for 5 seconds.

Then while still holding down the Up Arrow button and the Down Arrow button, press the Enter button.

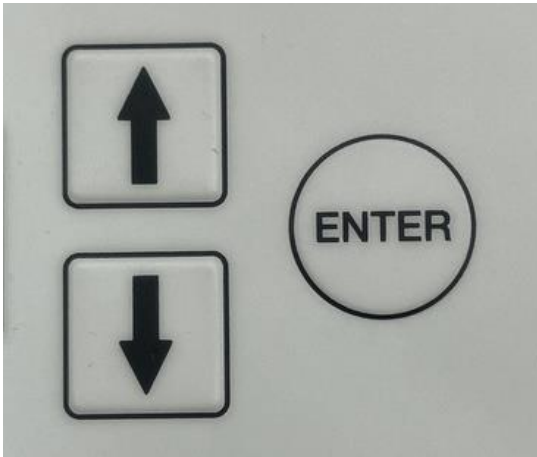

The Service User Interface screen will appear.

Use the procedures in the following pages to use Service User Interface

GP 6.2.1 SPEED ADJUST Procedure

Note: The SPEED ADJUST feature is for future printer introductions. It is not used at the moment.

If you accidentally change the SPEED ADJUST settings, follow the below procedure to reset it to factory settings.

1. At the top level screen,

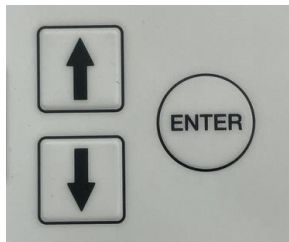
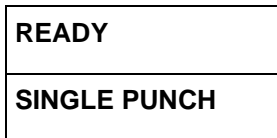

Press and hold both the Up Arrow button and the Down Arrow button for 5 seconds.

Then while still holding down both the Up Arrow button and the Down Arrow button, press the Enter button.

The Service User Interface screen will appear.

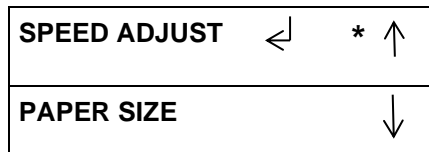

2. Press the ENTER button when the return symbol is next to the word SPEED ADJUST. To display the display the SPEED ADJUST screen.

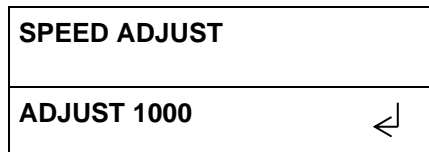

3. Press the down arrow to scroll through the speed options until the return symbol is next to RESET option.

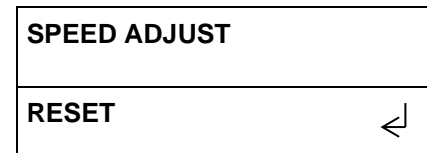

4. Press the ENTER button to reset
5. Press the up arrow to display the EXIT / SPEED ADJUST screen.

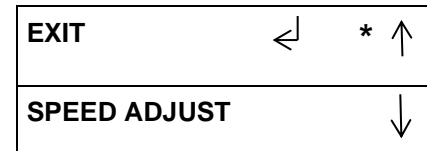

6. Press the ENTER button to return to the top level screen

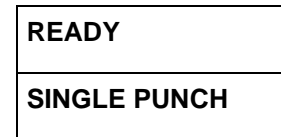

GP 6.2.2 SPEED (DFA) Procedure- for DFA configurations only

Do the following to select the Speed (DFA) option that lets you select the speed that the paper moves through the Punch.

Nuvera Speed	Punch Speed
100, 120, 144	1020
157	1090
200, 240, 288	1020
314	1090

1. At the top level screen,

READY
SINGLE PUNCH

Press and hold both the Up Arrow button and the Down Arrow button for 5 seconds.

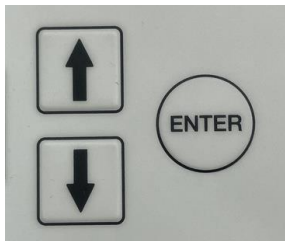

Then while still holding down both the Up Arrow button and the Down Arrow button, press the Enter button.

The Service User Interface screen will appear.

SPEED (DFA)	←	*	↑
MAX BYPASS			↓

2. Press the ENTER button when the return symbol is next to the word SPEED (DFA). To display the display the SPEED (DFA) screen.

SPEED (DFA)
1090 MM/S

3. Press the down arrow to scroll through the speed options until the return is next to the desired option.

- 1090 MM/S
- 1020 MM/S
- 1280 (157MAX)
- 1280 (144MAX)
- 1130 (157MAX)
- 1130 (144MAX)
- 973 (157MAX)
- 973 (144MAX)
- CUSTOM (157MAX)
- CUSTOM (144MAX)

4. Press the ENTER button to set the speed and return to the SPEED (DFA) screen.

SPEED (DFA)	←	*	↑
MAX BYPASS			↓

5. Press the up arrow to display the EXIT / SPEED (DFA) screen.

EXIT	←	*	↑
SPEED (DFA)			↓

6. Press the ENTER button to return to the top level screen

READY
SINGLE PUNCH

GP 6.2.3 PAPER SIZE Procedure

Do the following to select ANSI or ISO paper sizes.

1. At the top level screen,

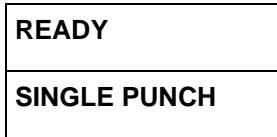

Press and hold both the Up Arrow button and the Down Arrow button for 5 seconds.

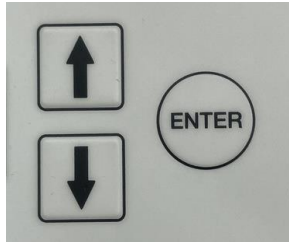

Then while still holding down both the Up Arrow button and the Down Arrow button, press the Enter button.

The Service User Interface screen will appear.

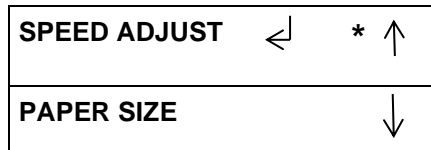

2. Press the ENTER button when the return symbol is next to the word Paper Size to display the Paper Size screen.

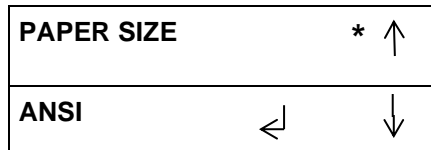

3. Press the down arrow to scroll through the speed options

- ANSI
- ISO

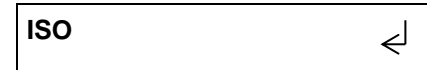
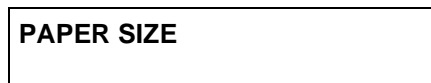

- If you are running LTR/11x17/STMT sizes – set the “Paper Size” setting to ANSI.
- If you are running one of the ISO sizes (A3, A4, A5) set the “Paper Size” setting to ISO.

4. When the return symbol is next to the desired paper size, press the ENTER button to set the paper size and return to the PAPER SIZE / PREVIOUS MENU screen.

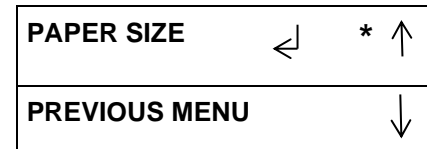

5. Press the up arrow twice to display the EXIT screen.

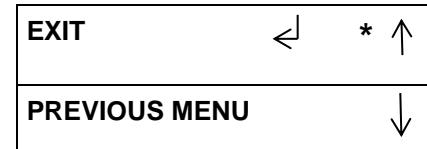

6. Press the ENTER button to return to the top level screen

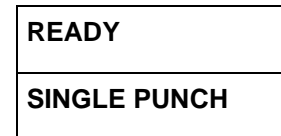

GP 6.2.4 MAX BYPASS Setting

Do the following to set the maximum bypass sheet length through FuturoPunch Pro.

1. At the top level screen,

READY
SINGLE PUNCH

Press and hold both the Up Arrow button and the Down Arrow button for 5 seconds.

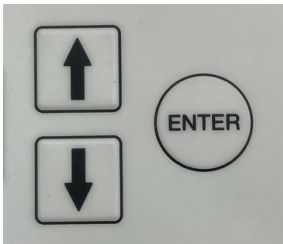

Then while still holding down the Up Arrow button and the Down Arrow button, press the Enter button.

The Service User Interface screen will appear.

SPEED ADJUST	←	*	↑
PAPER SIZE			↓

2. Press the down arrow button to move the return symbol next to MAX BYPASS. Press OK to enter the Max Bypass setting

PAPER SIZE		*	↑
MAX BYPASS	←		↓

3. The below screen will appear

MAX BYPASS		*	↑
488mm	←		↓

4. 762mm is the Max Bypass setting. To reduce the Max Bypass setting, press the down arrow to the desired setting, and then press OK.
5. The below screen will appear. You may now return to the Previous Menu or Exit to the Main screen.

MAX BYPASS	←	↑
PREVIOUS MENU		↓

GP 6.2.5 RUN MODE Setting

When FuturoPunch Pro is connected to a finisher this menu will show CONNECTED

When FuturoPunch Pro is not connected to a finisher and the punch is powered ON, do the following to select the desired run mode.

1. At the top level screen,

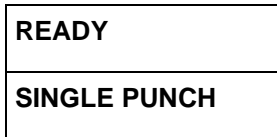

Press and hold the both Up Arrow button and the Down Arrow button for 5 seconds.

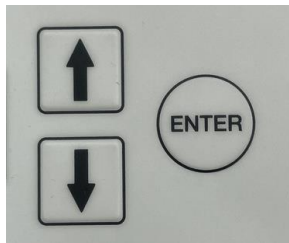

Then while still holding down the Up Arrow button and the Down Arrow button, press the Enter button.

The Service User Interface screen will appear.

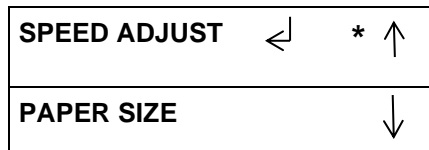

2. Press the down arrow so the return symbol is next to the words RUN MODE. Then press OK to enter the RUN MODE setting.

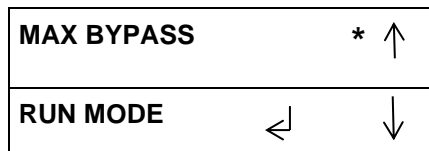

3. Press the down arrow to scroll through the speed options
 - AUTO RUN – This feature is used for manufacturing set-up only.
 - AUTO CYCLE – Covering Sensor S25 will enable all components: all motors, all solenoids. It can be used to check the functioning of all motors and solenoids.
4. Press the OK button to set the RUN MODE and return to Service mode options. Press up or down arrow button to exit to Main screen.

GP 6.2.6 DIE CYCLES

Do the following to view the number of cycles the die set that is currently installed in the machine.

1. At the top level screen,

READY
SINGLE PUNCH

Press and hold the both Up Arrow button and the Down Arrow button for 5 seconds.

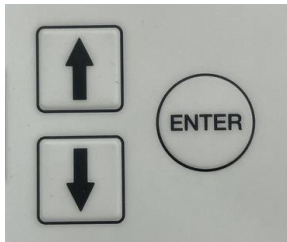

Then while still holding down the Up Arrow button and the Down Arrow button, press the Enter button.

The Service User Interface screen will appear.

SPEED ADJUST	↶	*	↑
PAPER SIZE			↓

2. Press the down arrow so the return symbol is next to DIE CYCLES and then press OK.

RUN MODE		*	↑
DIE CYCLES	↶		↓

DIE CYCLES		*	↑
501, 175			↓

3. Press OK to return to the service menu. Press up or down arrow and exit to the Main screen.

GP 6.2.7 SENSORS Procedure

A sensor can fail in two modes:

- **Failed in High state:** Machine thinks there is no sheet even when a sheet is present. In this mode, the LCD will always show "0" for that sensor, and will not go to "1" when a sheet is present.
- **Failed in Low state:** The converse of the above. "PAPER JAM..." message will be seen on LCD.

It is unlikely for a sensor to fail in a Low state. Therefore a bad sensor will most likely not give a "PAPER JAM..." message.

When there is "Paper Jam..." it is most likely because there is a sheet/piece of paper, or paper dust collecting over the sensor.

Procedure

Do the following to check the status of any of the sensors.

The Sensors feature allows you to view the state of each of the 29 sensors to the FuturoPunch Pro.

Cover each sensor to check if the sensor status changes from "0" to "1".

- 0 means the sensor is open.
- 1 means the sensor is covered.

Do the following to check the sensors.

1. At the top level screen,

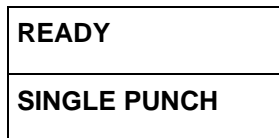

Press and hold both the Up Arrow button and the Down Arrow button for 5 seconds.

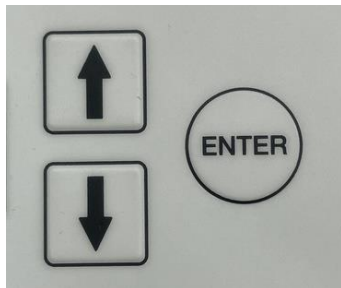

Then while still holding down the Up Arrow button and the Down Arrow button, press the Enter button.

The Service User Interface screen will appear.

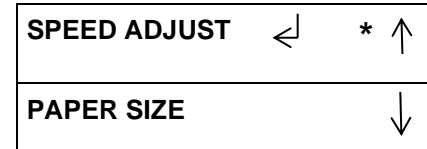

NOTE: Door can be open to do this.

2. Press the down arrow three times so the return symbol is next to the words SENSORS.



3. Press the ENTER button when the return symbol is next to the word SENSORS to display the display the first SENSORS screen.

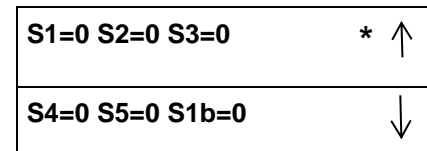

Uncovered = 0; Covered = 1

4. Press the down arrow to scroll through the sensor options.

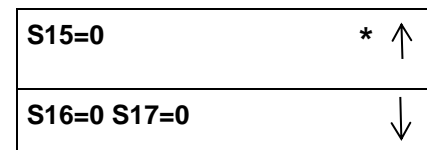
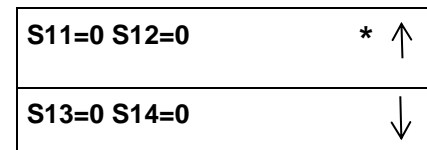
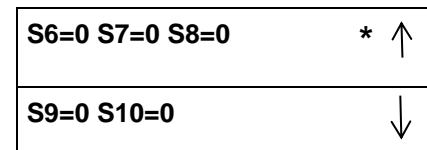

S18=0 S19=0	* ↑
S20=0 S21=0	↓

S22=0 S23=0	* ↑
S24=0 S25=0	↓

S26=0 S27=0	* ↑
S28=1	↓

When the Steering Carriage moves left/right, the Align Home Sensor (S28) is covered / uncovered.

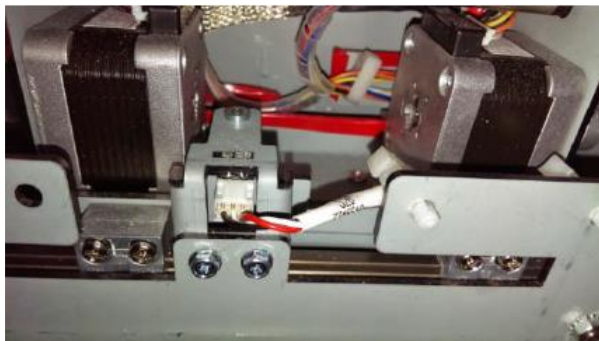

Sensor S28 covered

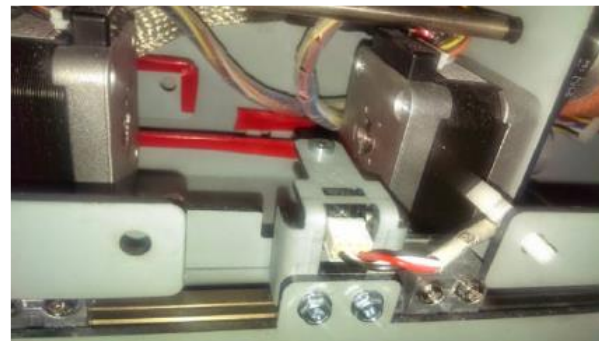

Sensor S28 uncovered

- If you use the down arrow to scroll through the complete list:
When you scroll down from the S26-S27-S28 screen, the system displays the Previous Menu / EXIT screen.

PREVIOUS MENU ←	* ↑
EXIT	↓

You can:

- Press the up arrow to return to the last sensor screen.
- Press the down arrow to move the return symbol is next to the word EXIT. Then press the ENTER button to return to the top level screen

READY
SINGLE PUNCH

- If you use the up arrow to scroll up from the S1-S2-S3-S-S5 screen:

S1=0 S2=0 S3=0	* ↑
S4=0 S5=0	↓

The system displays the EXIT / Previous Menu screen.

EXIT	* ↑
PREVIOUS MENU ←	↓

You can Exit to Main menu or return to Previous menu.

GP 6.2.8 I/O SIGNALS Procedure

The I/O SIGNALS feature allows you to view the status of the communication signals.

Procedure

Do the following to check the signals

1. At the top level screen,

READY
SINGLE PUNCH

Press and hold both the Up Arrow button and the Down Arrow button for 5 seconds.

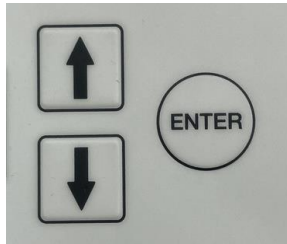

Then while still holding down the Up Arrow button and the Down Arrow button, press the Enter button.

The Service User Interface screen will appear.

SPEED (DFA)	↩	* ↑
PAPER SIZE		↓

2. Press the down arrow so the return symbol is next to the words DFA STATUS.

SENSORS		* ↑
I/O SIGNALS	↩	↓

3. Press the ENTER button when the return symbol is next to the word DFA STATUS.to display the display the first DFA STATUS screen.

C0=0 C1=0 C2=0		* ↑
C3=0 C4=0 C5=0		↓

4. Press the down arrow to scroll through the DFA STATUS options.

C6=0 C7=0		* ↑
S0=0 S1=0 S2=0		↓

S3=0 S4=0 S5=0		* ↑
S6=0 S7=0		↓

5. If you use the down arrow to scroll through the complete list:
When you scroll down from the S3=0 S4=0 S5=0 screen, the system displays the Previous Menu / EXIT screen.

PREVIOUS MENU	↩	* ↑
EXIT		↓

You can:

- Press the up arrow to return to the last sensor screen.
- Press the down arrow to move the return symbol is next to the word EXIT. Then press the ENTER button to return to the top level screen

READY
SINGLE PUNCH

GP 6.2.9 DFA STATUS Procedure- DFA Configurations only

The I/O SIGNALS feature allows you to view the status of the communication signals.

Procedure

Do the following to check the signals

1. At the top level screen,

READY
SINGLE PUNCH

Press and hold both the Up Arrow button and the Down Arrow button for 5 seconds.

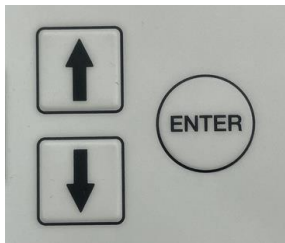

Then while still holding down the Up Arrow button and the Down Arrow button, press the Enter button.

The Service User Interface screen will appear.

SPEED (DFA)	⏪	*	↑
MAX BYPASS			↓

2. Press the down arrow so the return symbol is next to the words DFA STATUS.

SENSORS		*	↑
DFA STATUS.	⏪		↓

3. Press the ENTER button when the return symbol is next to the word DFA STATUS to display the first DFA STATUS screen.

C0=0 C1=0 C2=0	*	↑
C3=0 C4=0 C5=0		↓

4. Press the down arrow to scroll through the DFA STATUS options.

C6=0 C7=0	*	↑
S0=0 S1=0 S2=0		↓

S3=0 S4=0 S5=0	*	↑
S6=0 S7=0		↓

5. If you use the down arrow to scroll through the complete list: When you scroll down from the S3=0 S4=0 S5=0 screen, the system displays the Previous Menu / EXIT screen.

PREVIOUS MENU	⏪	*	↑
EXIT			↓

You can:

- Press the up arrow to return to the last sensor screen.
- Press the down arrow to move the return symbol is next to the word EXIT. Then press the ENTER button to return to the top level screen

READY
SINGLE PUNCH

GP 6.2.10 SOLENOIDS Procedure

Do the following to test any of the solenoids.

The Solenoid feature allows you to test the operation of each of the 8 solenoids to the FuturoPunch Pro.

Do the following to check the solenoids.

1. At the top level screen,

READY
SINGLE PUNCH

Press and hold both the Up Arrow button and the Down Arrow button for 5 seconds.

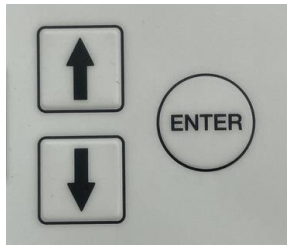

Then while still holding down the Up Arrow button and the Down Arrow button, press the Enter button.

The Service User Interface screen will appear.

SPEED ADJUST	←	*	↑
PAPER SIZE			↓

2. Press the down arrow five times so the return symbol is next to the words SOLENOIDS.

I/O SIGNALS		*	↑
SOLENOIDS	←		↓

3. Press the ENTER button when the return symbol is next to the word SOLENOIDS to display the display the SOLENOIDS screen.

L1 L2 L3 L4	*
L5 L6 L7 L8	BACK

4. To check the Solenoids:

NOTE: Door needs to be closed or Interlock Cheater inserted to do this.

- Press the down arrow to scroll through the solenoid options.
- The selected solenoid will flash on and off.
- Press the Enter button to turn the selected solenoid on.
- You should hear the Solenoid click.
- Repeat as needed to check the other Solenoids.
- If a Solenoid does not operate do GP 6.22 Solenoid Cleaning and Inspection.

5. When you finish checking the Solenoids:

- Press the up arrow or down arrow to highlight the BACK option.
- Press the ENTER button to display the I/O SIGNALS / SOLENOIDS menu.

I/O SIGNALS	*	↑
SOLENOIDS	←	↓

6. Press the up arrow to display the EXIT / SPEED ADJUST screen.

EXIT	←	*	↑
SPEED ADJUST			↓

7. Press the ENTER button to return to the top level screen

READY
SINGLE PUNCH

GP 6.2.11 MOTORS Procedure

Do the following to test any of the Stepper Motors.

The Motors feature allows you to test the operation of each of the 7 of the 8 stepper motors in the FuturoPunch Pro.

Do the following to check the Motors.

1. At the top level screen,

READY
SINGLE PUNCH

Press and hold both the Up Arrow button and the Down Arrow button for 5 seconds.

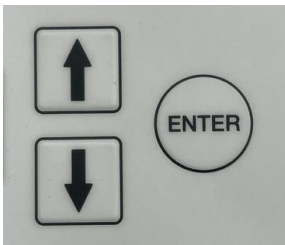

Then while still holding down the Up Arrow button and the Down Arrow button, press the Enter button.

The Service User Interface screen will appear.

SPEED ADJUST	←	*	↑
PAPER SIZE			↓

2. Press the down arrow six times so the return symbol is next to the word MOTORS.

SOLENOIDS		*	↑
MOTORS	←		↓

3. Press the ENTER button when the return symbol is next to the word Motors to display the display the first MOTORS screen.

M1 M2 M3 M4	*
M6 M7 M8	BACK

4. To check the Stepper Motors:

NOTE: Door needs to be closed to do this.

- Press the down arrow to scroll through the motor options.
- The selected motor will flash on and off.
- Press the Enter button to turn the selected motor on.
- You should hear the motor running (a low whine for Motors M1, M2, M6, M7 & M8) (a soft whine for Motors M3, & M4),
- Press the Enter button again to turn the selected motor off
- Repeat as needed to check the other Stepper Motors.

5. When you finish checking the Motors:

- Press the up or down arrow to highlight the BACK option.
- Press the ENTER button to display the SOLENOIDS / MOTORS menu.

SOLENOIDS	*	↑
MOTORS	←	↓

6. Press the up arrow to display the EXIT / SPEED (DFA) screen.

EXIT	←	*	↑
SPEED ADJUST			↓

7. Press the ENTER button to return to the top level screen

READY
SINGLE PUNCH

GP 6.2.12 FUNCTION TESTS Procedure (Cycle Punch, Aligner Test, Fan Test)

Do the following to test any of the Function Tests.

The Function Tests feature allows you to run the Cycle Punch, Aligner Test, and Fan Test routines.

Do the following to check the Motors.

1. At the top level screen,

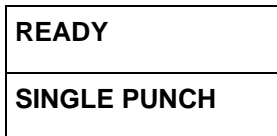

Press and hold both the Up Arrow button and the Down Arrow button for 5 seconds.

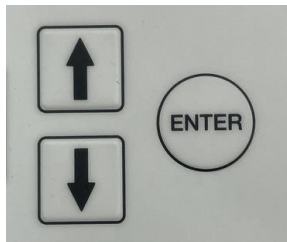

Then while still holding down the Up Arrow button and the Down Arrow button, press the Enter button.

The Service User Interface screen will appear.

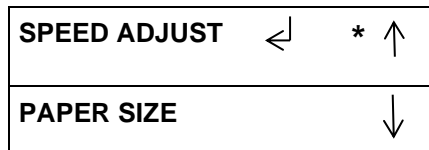

2. Press the down arrow seven times so the return symbol is next to the words FUNCTION TESTS.

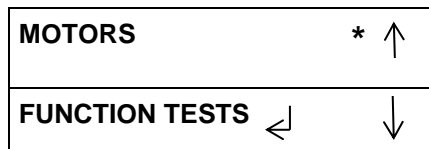

3. Press the ENTER button when the return symbol is next to the words FUNCTION TESTS to display the display the FUNCTION TESTS screen.

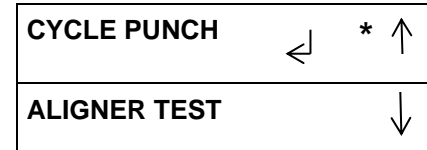

4. To run the CYCLE PUNCH test:
 - Press the Enter button when the return symbol is next to the words CYCLE PUNCH.
 - The CYCLE PUNCH Test starts the Punch Motor, waits for 2 seconds, the triggers the Punch at 1 punch per second for 5 cycles.
 - After the test is complete it stops automatically, you may scroll down to Previous Menu or Exit.
5. To run the ALIGNER TEST:
 - Press the down arrow to move the return symbol next to the words ALIGNER TEST:.
 - Press the Enter button when the return symbol is next to the words ALIGNER TEST.
 - The Aligner Test moves the home Aligner CW 10mm, back to home, CCW 10mm, then back to home. It repeats this cycle 5 times.
 - After the test is complete it stops automatically, you may scroll down to Previous Menu or Exit.
6. To run the FAN TEST:
 - Press the down arrow to move the return symbol next to the words FAN TEST:.
 - Press the Enter button when the return symbol is next to the words FAN TEST.
 - The Fan Test turns the Exhaust Fan on and off.
 - After the test is complete it stops automatically, you may scroll down to Previous Menu or Exit.

NOTE: The FUNCTION 4 test is not assigned.

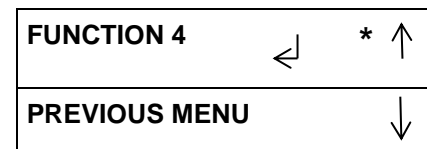

(Cont.)

7. When you finish running the tests:
- From the CYCLE PUNCH screen, press the up arrow twice to display the EXIT / PREVIOUS MENU screen.
 - From the ALIGNER TEST, press the up arrow three times to display the EXIT / PREVIOUS MENU screen.
 - From the FAN TEST, press the up arrow four times to display the EXIT / PREVIOUS MENU screen.

EXIT	↵	*	↑
PREVIOUS MENU			↓

8. When the return symbol is next to the word EXIT, press the ENTER button to return to the top level screen

READY
SINGLE PUNCH

GP 6.2.13 SKEW OFFSETS Procedure

Do the following to setup the skew offsets to straighten and offset punch depth.

Do the following to setup the skew offsets.

1. At the top level screen,

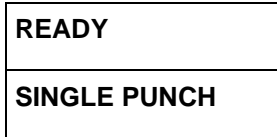

Press and hold both the Up Arrow button and the Down Arrow button for 5 seconds.

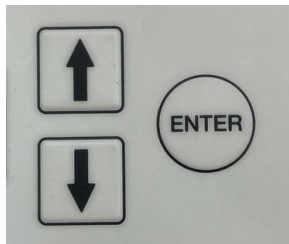

Then while still holding down the Up Arrow button and the Down Arrow button, press the Enter button.

The Service User Interface screen will appear.

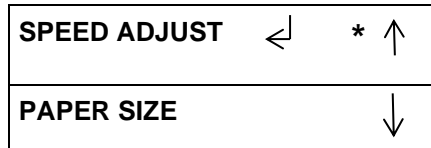

2. Press the down arrow so the return symbol is next to the words SKEW OFFSETS.

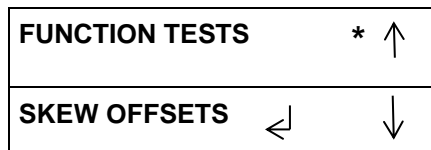

3. Press the ENTER button when the return symbol is next to the words SKEW OFFSETS to display the SKEW OFFSETS screen.

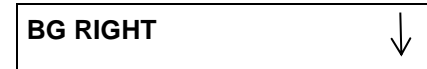
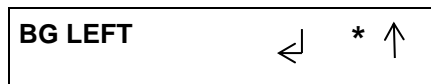

4. Press the down arrow to scroll through the Skew Offset options.

- BG LEFT
- BG RIGHT
- BG DP L LEFT- *DFA Configurations only.*
(for LTR Short Edge and A4 Short edge Double punch)
- BG DP L RIGHT- *DFA Configurations only.*
(for LTR Short Edge and A4 Short edge Double punch)
- BG DP XL LEFT- *DFA Configurations only.*
(for 11 x 17 Short Edge and A3 Short Edge Double punch)
- BG DP XL RIGHT- *DFA Configurations only.*
(for 11 x 17 Short Edge and A3 Short Edge Double punch)

5. Scroll until the return symbol is next to the desired Skew Offset,

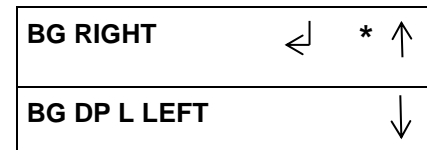

- Press the ENTER key to display the Skew Offset screen for that setting.

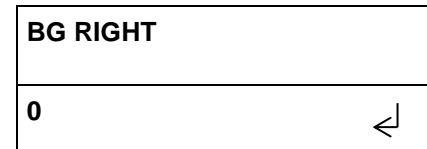

- Press the up arrow button or the down arrow button to change the offset by ± 1 increment.

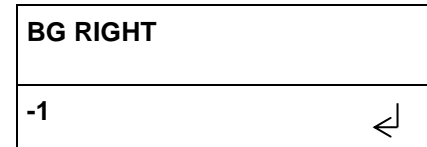

- When you reach the desired Skew Offset, press the ENTER button to return to the previous Skew Offset screen.

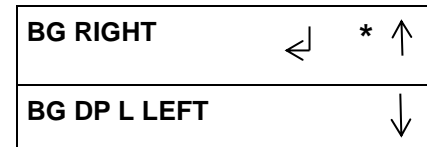

- If you want to change another Skew Offset, press the down arrow to scroll through the Skew Offset options, then repeat the this entire step for the other Skew Offset option.

6. From any Skew Offset screen, you can scroll up or down through the entire list of Skew Offset options.

BG DP L RIGHT	* ↑
BG DP XL LEFT	↵ ↓

7. If you use the down arrow to scroll through the complete list of skew offset options, the system displays the following screens.

BG DP XL RIGHT	↵ * ↑
PREVIOUS MENU	↓

PREVIOUS MENU	* ↑
EXIT	↵ ↓

- You may return to the main Service mode menu or Exit to the Top level screen.

(Cont.)

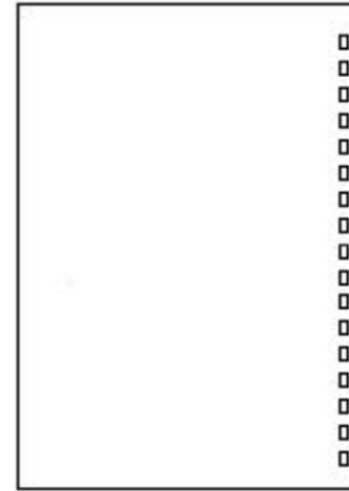

Holes parallel to the edge.

To check Skew, fold the sheet as shown.

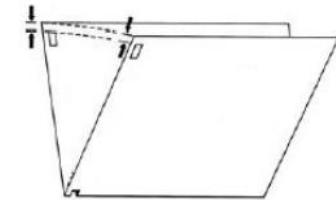
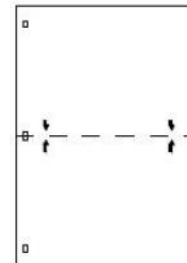

The last holes should line up.

Bottom most hole is at correct Backgage depth, but the top hole is too far from the edge of the paper.

BG RIGHT '-' Select 1 1, 2, 3...etc. until the holes are parallel to the edge.

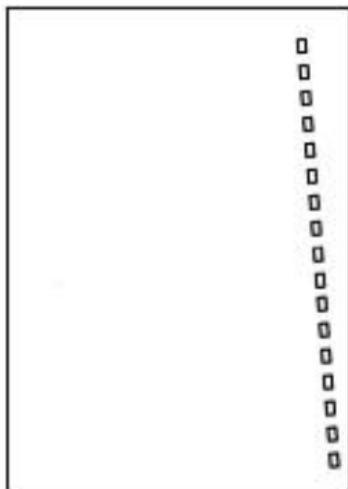

Top most hole is at correct Backgage depth, but the bottom hole is too far from the edge of the paper.

BG LEFT '-' Select 1 1, 2, 3...etc. until the holes are parallel to the edge.

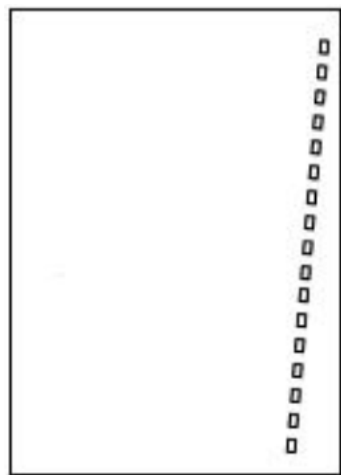

The bottom hole is in the correct position, but the top hole is too close to the edge of the paper.

BG RIGHT '+' Select 1 1, 2, 3...etc. until the holes are parallel to the edge.

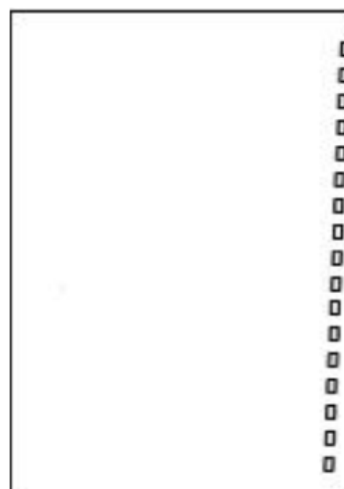

The top hole is in the correct position, but the bottom hole is too close to the edge of the paper.

BG LEFT '+' Select 1 1, 2, 3...etc. until the holes are parallel to the edge.

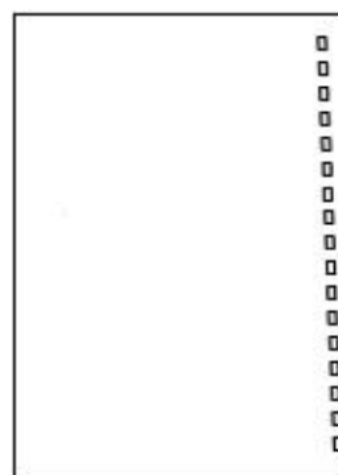

DFA Configurations only- For Double punch skew offsets, the same principle applies. Examples shown below:

BG DP L RIGHT '+' Select 1, 2, 3...etc. until the holes are parallel to the edge.

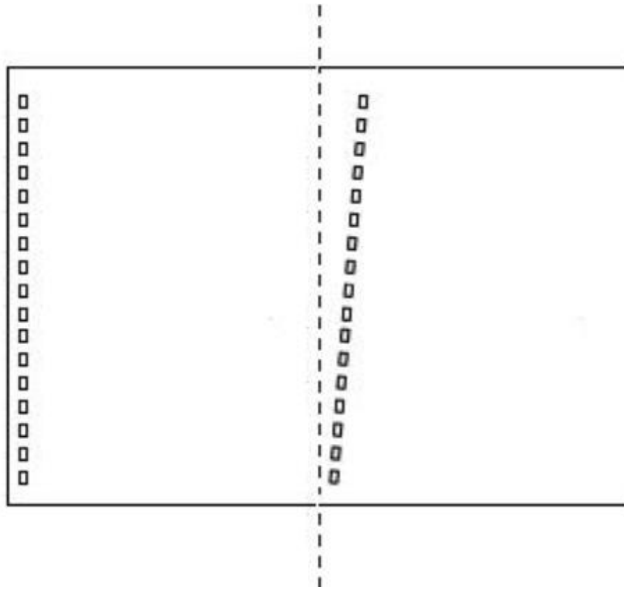

BG DP L LEFT '+' Select 1, 2, 3...etc. until the holes are parallel to the edge.

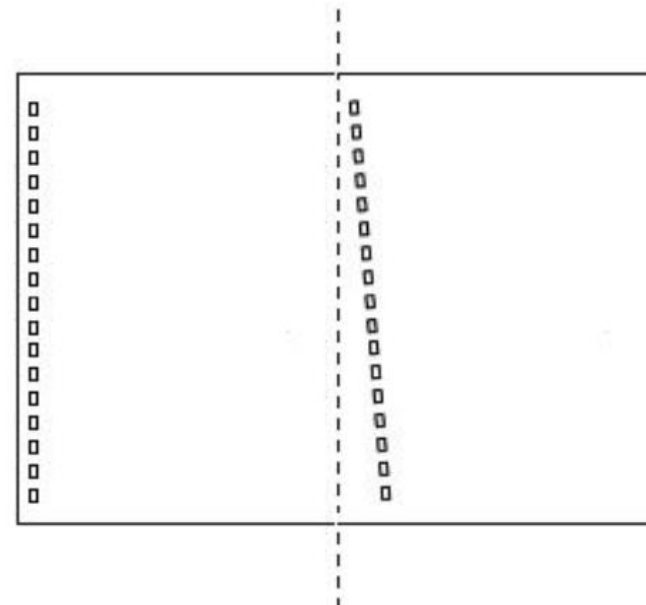

GP 6.2.14 ALIGN OFFSETS Procedure

Do the following to make adjustments to the Align Offsets. The Align Offsets is same as the Alignment Offset in the User setting, except:

- The User Alignment setting adjusts the Alignment position of all sheets (regardless of size) that are processed by FuturoPunch Pro
- The ALIGN OFFSETS described here are performed to individual sensors. Therefore adjusting a sensor's Align Offsets will only impact the sheet sizes using that particular sensor.

The below table shows the sensor for each sheet size:

Sensor	Sheet sizes
S11	SRA4-LEF, SRA3-SEF
S12	A4-LEF, A4 tab, A3-SEF, 9"X12"-LEF, 12"X18"-SEF
S13	LTR-LEF, LTR tab, 11x17-SEF
S14	9"X12"-SEF, SRA5-LEF, SRA4-SEF
S15	1/2LTR-LEF, 1/2LTR tab, LTR-SEF, Legal SEF A5-LEF, A5 tab, A4-SEF

1. At the top level screen,

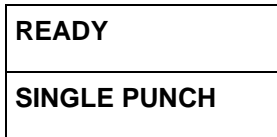

Press and hold both the Up Arrow button and the Down Arrow button for 5 seconds.

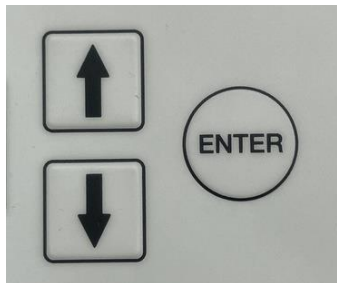

Then while still holding down the Up Arrow button and the Down Arrow button, press the Enter button.

The Service User Interface screen will appear.

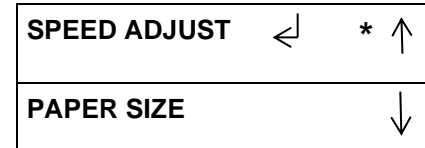

2. Press the down arrow button so the return symbol is next to the words ALIGN OFFSETS.



3. Press the ENTER button when the return symbol is next to the words ALIGN OFFSETS to display the ALIGN OFFSETS screen.

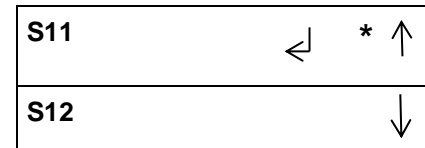

4. Press the down arrow to scroll through the Align Offset options.

- S11
- S12
- S13
- S14
- S15

5. Scroll until the return symbol is next to the desired Align Offset,

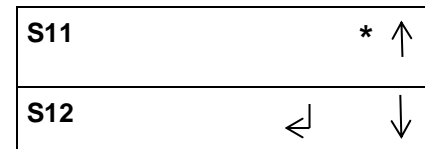

- Press the ENTER key to display the Align Offset screen for that setting.

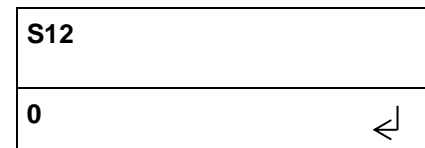

- Press the up arrow button or the down arrow button to change the offset by ± 1 increment.

S12	
-1	↵

- When you reach the desired Align Offset, press the ENTER button to return to the previous Align Offset screen.

S11	* ↑
S12	↵ ↓

- If you want to change another Align Offset, press the down arrow to scroll through the Align Offset options, then repeat the entire step 5 for the other Align Offset option.

- From any Align Offset screen, you can scroll up or down through the entire list of Align Offset options.

S14	* ↑
S15	↵ ↓

- If you use the down arrow to scroll through the complete list of align offset options, the system displays the S15 /PREVIOUS MENU screen.

S15	↵ * ↑
PREVIOUS MENU	↓

From this screen you can:

- Select S15
- Press the up arrow to return to the previous Align Offsets screen.
- Press the down arrow to move the return symbol is next to the word PREVIOUS MENU.

- If you press the down arrow when the return symbol is next to the word PREVIOUS MENU, the system displays the PREVIOUS MENU / EXIT screen.

PREVIOUS MENU	* ↑
EXIT	↵ ↓

- You may return to Previous Menu or Exit to Main screen.

GP 6.2.15 LOG

The LOG file download option will store the following data for download via USB.

Debug data for last 50 sheets.

- Sheet size measured i.e S,M,L,LG or XL
- Skew sensors used
- First deskew steps
- Alignment sensor used
- Second deskew steps.
- Align fail safe stop (if occurred)

Sensor timings for last 10 sheets.

- Punch mode, time from LE S1 to LE S8
- Punch mode, time from LE S8 to LE at S25

Other data

- Punch cycle count
- Bypass cycle count
- Individual die type counts
- Record the last 20 Jam codes in a column format

Do the following steps to capture the LOG files.

1. Remove (2) M4 screws and the USB/Debug/E-wire port cover.
2. Insert a USB flash drive.
3. At the top level screen,

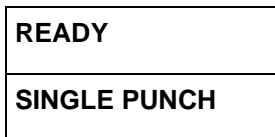

Press and hold both the Up Arrow button and the Down Arrow button for 5 seconds.

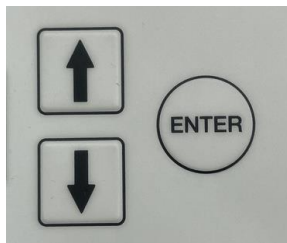

Then while still holding down the Up Arrow button and the Down Arrow button, press the Enter button.

The Service User Interface screen will appear.



4. Press the down arrow so the return symbol is next to the words ALIGN OFFSETS.



5. Pressing OK when the return symbol is next to LOG will open the LOG file capture option.

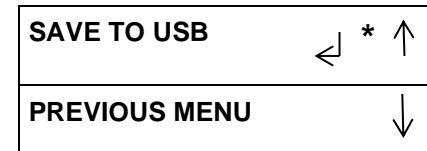

6. You have the following options:

- Pressing OK will save the LOG files to the inserted USB flash drive. After the Complete message is displayed, exit to the Previous Menu or Exit. You may remove the USB flash drive and replace the cover.
- Return to the Previous Menu
- Exit to Top level screen

GP 6.2.16 FIRMWARE UPGRADE Procedure

Do the following to upgrade the firmware.

1. Open the Front door of FuturoPunch Pro before performing the Firmware upgrade procedure. It is required to have the Front door open during the process to prevent the system from accidentally starting a print job or from entering a mode that may interfere with the Firmware upgrade process.
2. Remove (2) M4 screws and the USB port cover from the back of the machine.
3. Save the firmware file you want to upload to the USB flash drive provided.
 IMPORTANT NOTE: Only one Main and one Comm file should be present in the USB flash drive.
4. At the top level screen,

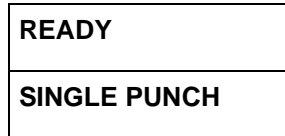

Press and hold both the Up Arrow button and the Down Arrow button for 5 seconds.

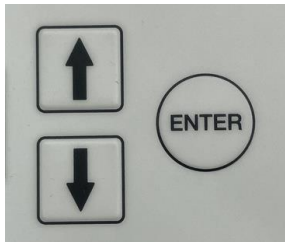

Then while still holding down the Up Arrow button and the Down Arrow button, press the Enter button.

The Service User Interface screen will appear.

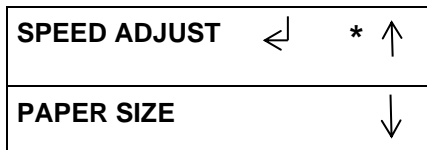

5. Insert the USB Flash drive with the firmware file you want to upload.
 Note: this step can be done at any time before you press the Enter button for Main or Comm firmware upload (in Step 8).

6. Press the down arrow button so the return symbol is next to the words FIRMWARE UPGRADE.

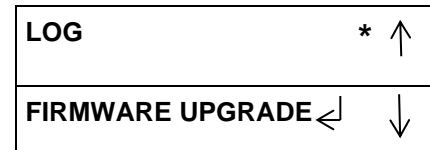

7. Press the ENTER button when the return symbol is next to the words FIRMWARE UPGRADE to display the FIRMWARE UPGRADE screen.



8. Press the down arrow to scroll through the Firmware Upgrade options.
 - MAIN (the Control Board) – Select this to update the Main firmware.
 - COMMS (The Communications Board) – Select this to update the Comm firmware

If uploading both, do MAIN first.

- PREVIOUS MENU takes you to the FIRMWARE UPGRADE / EXIT screen
9. If you press the ENTER button when the return symbol is next to the word MAIN, the system displays this screen.

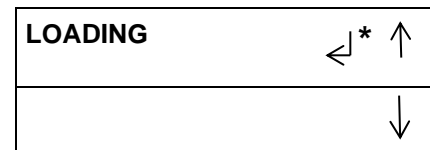

- When the update is complete, the system displays this screen

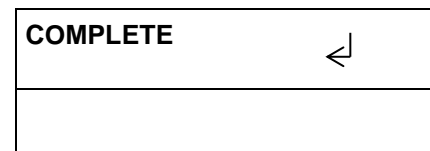

- Press ENTER to return to the Main Screen.

10. For COMM, COMPLETE is NOT displayed.

The system automatically returns to the previous screen.

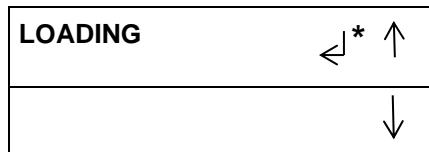

- Press the ENTER button to return the then MAIN / COMM screen.

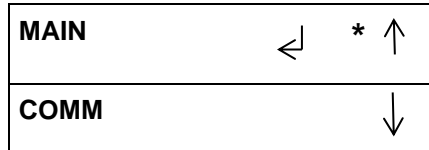

11. Press the down arrow to scroll through the Firmware Upgrade options until the return symbol is next to the Word EXIT.

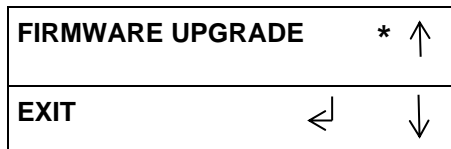

12. Press the ENTER button when the return symbol is next to the word EXIT to return to the top level screen.

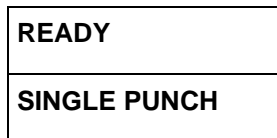

13. Remove the USB flash drive with the firmware file you uploaded.

14. Install the Cover for USB port and tighten the Screws (2).

15. Switch off the machine. Wait 10 seconds, and then switch the machine back on again.

GP 6.3 Undock the Punch (Moving the punch to Service position)

Use this procedure to move the punch to Service position

1. Undock the downstream device and move it at least 6 inches (150mm) away.
2. Open the Front door of FuturoPunch Pro.
3. Remove the M3 lock screw.



4. Pull the docking lever.



5. While having the docking lever pulled, move the machine to the right.



DFA configurations:

1. Remove the ground straps from the rear cover of FuturoPunch Pro.
2. Remove the (2) screws.



Screws

3. Slide the FuturoPunch Pro to Service position.



GP 6.4 Dock the punch (Moving the punch to Operating position)

Use this procedure to move the FuturoPunch Pro to operating position.

1. Slide the punch to Operating position

Note: If the FuturoPunch Pro does not easily slide to Operating and Service positions, level the FuturoPunch Pro using the adjustable casters.

2. Latch the docking bracket and install the M3 screw.
3. *For DFA configurations-* Install the (2) screws.
4. *For DFA configurations-* Install the ground straps to the Rear cover of FuturoPunch Pro.
5. Run a small test job in both Punch and Bypass mode to ensure the machine is working properly.

GP 6.5 Operational Inspection

Do the following on every service call to make sure the system is operating properly.

1. Make sure the punch operates smoothly and produces the desired holes in the customer's paper.
2. Refer to section 3.14 *Punch Specifications*.

GP 6.6 Internal Inspection

Do the following whenever the cover has been removed for corrective maintenance,

1. Visually inspect for defects and problems such as damaged components, loose screws or nuts, abraded wire insulation, loose terminals, etc.
2. Correct any problems before returning the machine to service.

GP 6.7 Die Set Service

The Die Set assembly is not serviceable other than inspection and periodic lubrication.

If a Die Set is at its end of life, it will tend to cause paper jam due to hanging chips. This is a result of die plate wear, and not pin wear, which cannot be corrected. When this occurs, the Die Set should be replaced with a new one.

GP 6.7.1 Die Set Life Expectancy

The FuturoPunch Pro Die Sets have a minimum life expectancy of 750K cycles (sheets of paper punched, when punching 75 gsm paper). With periodic lubrication and optimum paper types, life can exceed this number.

Use the Die Cycles feature on the User Interface to view the number of cycles on the Die Set.

Variables that affect life expectancy:

- Failure to follow the lubrication schedule or using the incorrect lubricant
- Variety and types of paper being punched
- Cover stocks being punched
- Length of the average job
- Other environmental conditions

GP 6.7.2 Die Set Components

Serviceable Components

- Punch pins [1]
- Felt pad (on some Die Sets) [2]

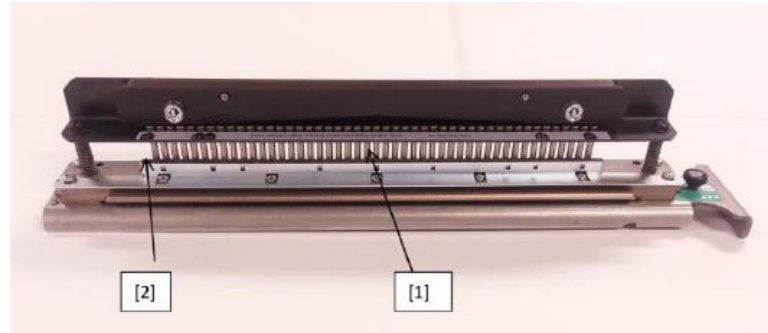

GP 6.7.3 Die Set Lubrication

Periodic lubrication extends the life of the Die Sets. This can be done by the user or the service technician.

Maintenance Schedule

Lubricate and inspect Die Set pins every 100K cycles.

Procedure

1. Inspect the punch pins for signs of wear or mis-alignment. Periodic lubrication extends the life of the Die Sets.
2. The customer or operator can perform this maintenance between technician inspections.



Inspect Punch Pins

To lubricate Die Set pins that do not have felt pads:

1. Depress the Die Set so that the pins protrude from the bottom plate.
2. Apply a drop of high quality machine oil to the end of each pin.
3. Wipe clean, leaving a light coat of oil on them.
4. Oil from the die may blemish the first few punched sheets after oil has been applied. Run test punched copies until clean copies can be made.

To lubricate Die Set pins that have felt pads:

1. Lubricate with a high quality machine oil.
2. Apply oil lightly along the length of the pad [1], but do not over saturate.
3. Do not use spray lubricants because they tend to dry up quickly and leave a sticky residue.
4. Oil from the die may blemish the first few punched sheets after oil has been applied. Run test punched copies until clean copies can be made.

Die Set Lubrication Points



Die Set Inspection

1. Set the Die Set on a table and press the top plate straight down at both ends at the same time and look for a smooth operation. The top plate and pins should retract fully when you release.



Check For Free Movement

2. Reinstall the Die Set into the punch and run several sheets of the customer's paper through the punch. Inspect the holes.
 - Holes should be clean and even with no tearing or frayed edges.
 - Holes should be punched completely, leaving no chip attached.Holes should be straight (no skew) and evenly spaced from the edge of the paper and aligned. (See, GP 6.2.13 SKEW OFFSETS Procedure)

GP 6.7.4 Die Set Shoulder Bolts

Do the following to inspect and lubricate the Die Set Shoulder Bolts every 200k Die cycles.

1. Lubricate with high quality Teflon-based grease.
2. Apply grease to Shoulder Bolts and Springs [2].
3. Wipe up any excess grease.

GP 6.8 External Cleaning

Do the following to clean the exterior of the FuturoPunch Pro.

1. Clean the exterior covers with a soft cloth moistened with mild detergent and warm water.

Do not use chemical cleaners or solvents as these may have a harmful effect. Use detergent sparingly to avoid contact with electrical components.



Warning: Make sure you disconnect the FuturoPunch Pro from its power source before cleaning. Failure to observe this warning could result in death or serious Injury. See *Section 0, page vii for other languages.*

GP 6.9 Internal Cleaning

Do the following to clean the interior of the FuturoPunch Pro.

1. Occasionally remove the covers and remove paper dust and chips. Paper dust can accumulate throughout the punch including around the motor and other electrical components.
Use a vacuum cleaner if possible. A small paintbrush can also be used but extreme care should be used around electrical components.
2. Clean non-electrical components with alcohol, an approved cleaner, or a soft cloth moistened with mild detergent and warm water.
3. Clean the Rollers with alcohol.



Warning: Make sure you disconnect the FuturoPunch Pro from its power source before cleaning. Failure to observe this warning could result in death or serious Injury. See *Section 0, page vii for other languages.*

GP 6.10 Base Cleaning

Chips and paper dust falls to the bottom of the punch. Clean every service call.

1. Clean with a vacuum cleaner each time the machine is serviced.
2. The customer can also do this between the technician's visits.

GP 6.11 Chip Bin Cleaning

Do the following on every service call to clean the Chip Tray.

1. Remove the Chip Bin and empty it.
2. Vacuum out paper chips and dust from the Chip Bin tray, especially at the holes on the sides of the Chip Tray.



GP 6.12 Die Guide Cleaning

Do the following to clean the Die Guide every 500K cycles.

1. Remove the Die Set and clean the guide [1] with a vacuum cleaner.



GP 6.13 Door Latch Inspection

Inspect the Door Latch every 1000K cycles.

The door latch must hold the door closed and ensure that the switch activation tab is depressing the door switch [1]. The switch tab [2] should press the switch button just so that it is close to bottom.

1. Ensure latch holds door closed.
2. Ensure switch is activated when the door is closed.
3. To adjust the door latch, see ADJ 1.1.



GP 6.14 Idler Roller and Idler Springs Inspection

Idler rollers press against the drive rollers and move the paper through the bypass [1] or the punch [2].

Maintenance Schedule

Inspect and clean every 1000K cycles.

Procedure

1. For the Idler Rollers in the following nips, inspect the rollers for wear, debris, toner marks, unevenness, and dents.

N1	N9
N2	N10
N3	N11
N4	N12
N5	N13
N8	N14

2. Inspect Springs (2) for each Idler Roller, and make sure they are correctly hooked.

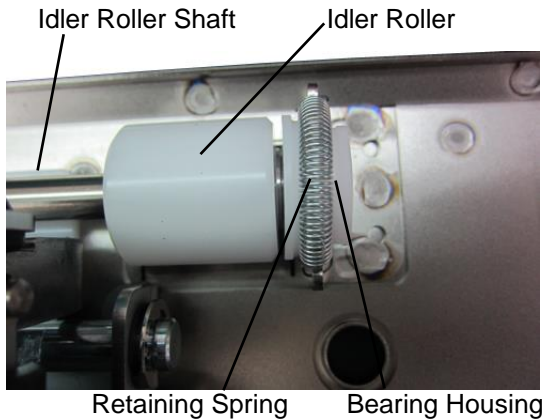

3. Inspect the Bearing Housing. The Bearing Housing should slide freely in the Bearing Forks.

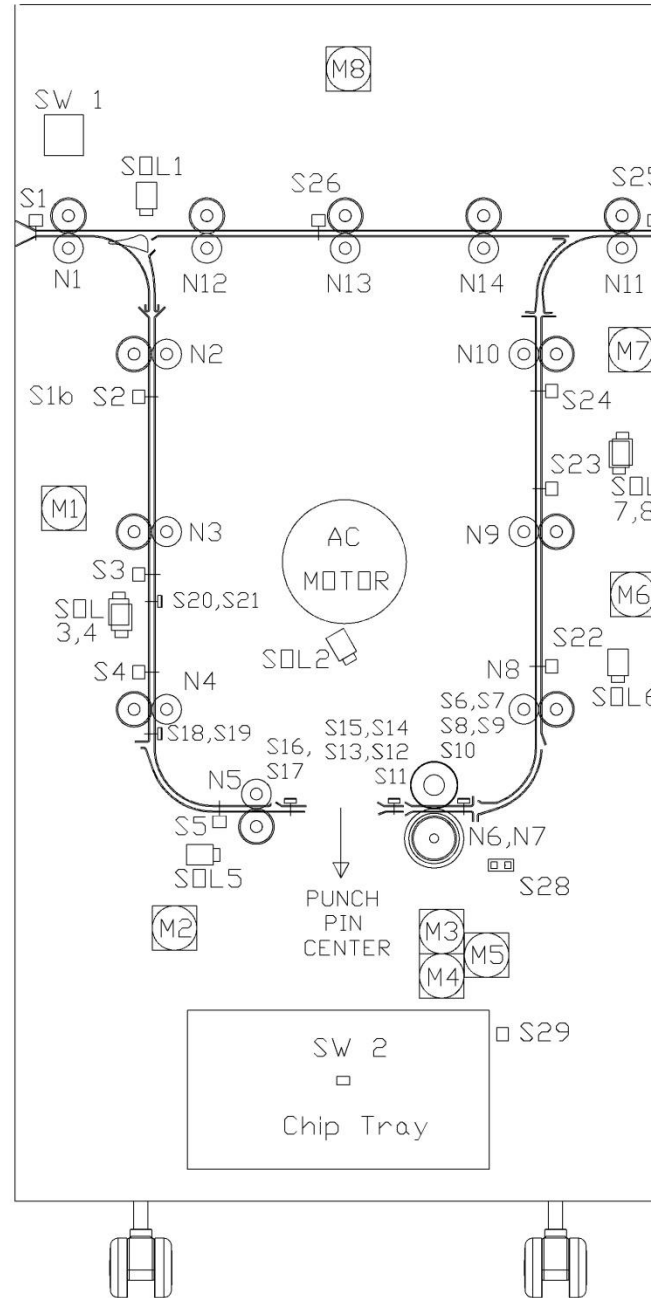

GP 6.14.1 Idler Roller Cleaning

Use this procedure to clean the Idler Rollers in these assemblies:

- Entrance Idler Panel.
- Acceleration Roller Idler Assy.
- Exit Idler Panel.
- Bypass Idler Assembly

Maintenance Schedule

Inspect and clean every 1000K cycles.

Procedure

1. Do REP 2.12 *Idler Roller Replacement* to remove the Idler Roller.

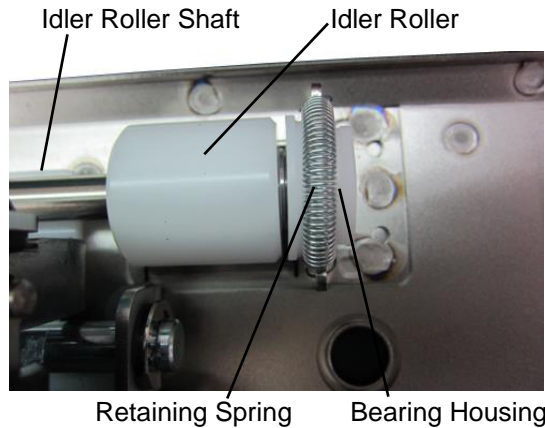

2. Clean the Idler Rollers with a soft cloth and alcohol.



3. Inspect rollers for wear patterns or groves. The roller surface should be smooth.
4. Ensure the rollers turn freely on the shaft and that the idler roller shaft "floats" freely in the bushing forks.
5. Do REP 2.12 *Idler Roller Replacement* to install the Idler Roller.

GP 6.14.2 Steering Idler Roller and Springs Inspection and Cleaning

Use the procedure to clean and inspect these Steering Idler Rollers and Springs.

- N6
- N7

Maintenance Schedule

Inspect and clean every 1000K cycles.

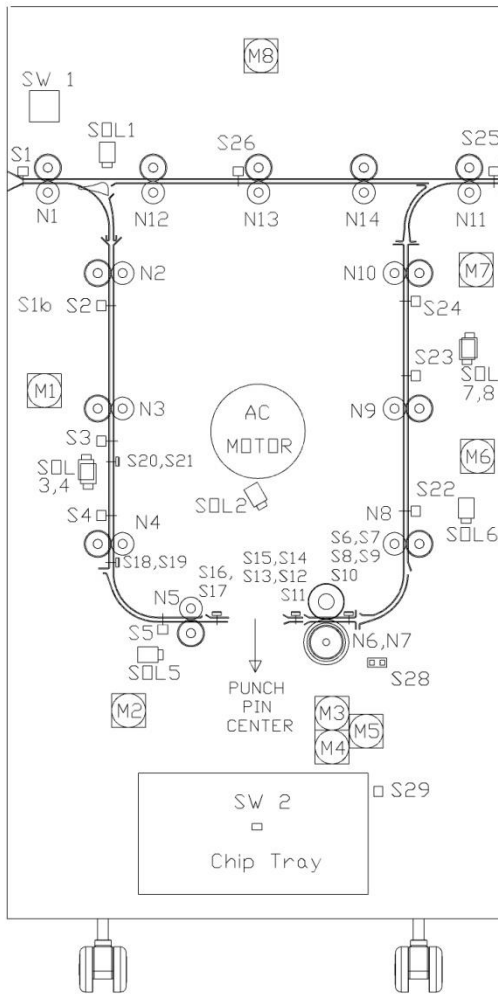

Procedure

To clean non-removable idler rollers:

1. Do REP 3.1.1 Punch Module Removal.
2. Clean the Steering Idler Rollers with a soft cloth and alcohol.

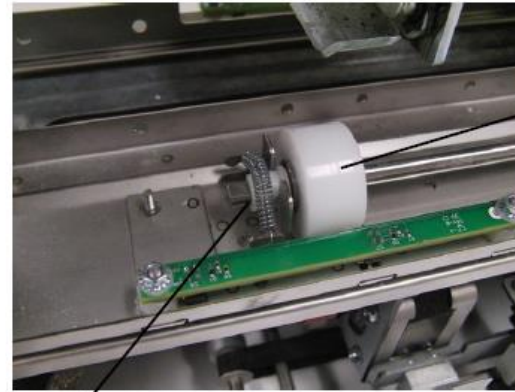

3. The roller surfaces should be free of debris, toner deposits, wear, unevenness, and dents.
4. Inspect the Steering Idler Springs. The Springs should be hooked securely and should be wrapped around the Bushing.
5. Do REP 3.1.2 Punch Module Installation.

GP 6.15 Drive Roller and Steering Drive Roller Inspection and Cleaning

Do this procedure to inspect and clean the Drive Rollers and Steering Drive Rollers.

Maintenance Schedule

Inspect and clean every 1000K cycles.

Procedure

Some drive rollers are not easily accessible. Those that are [1], should be inspected and cleaned when the idler rollers are removed.

Where practical, make sure the rollers are clean. Clean with a soft cloth and alcohol.

See also, GP 6.14.1 *Idler Roller Cleaning* on page 6-61.

It is recommended to clean the Drive Rollers with the Punch Module removed, because with the Punch Module removed it is easy to access all Drive Rollers.

1. Do REP 3.1.1 Punch Module Removal.
2. Clean all Drive Rollers N1 – N16 with a clean cloth and alcohol.
3. The Drive Roller should be free of toner deposits, wear marks, scuff marks, dents, etc.
4. Use the above procedure to clean the Steering Drive Rollers

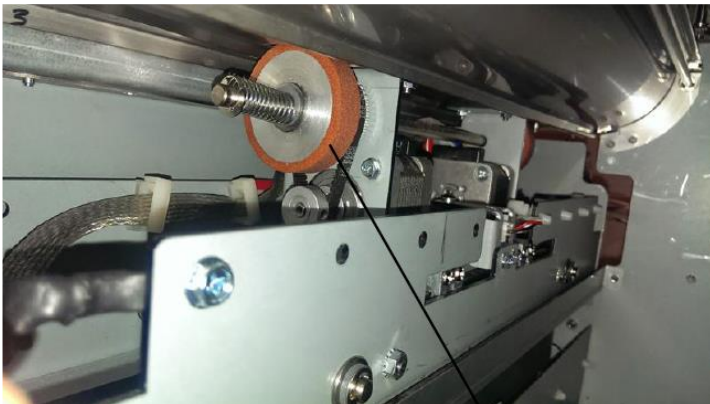

Steering Drive Rollers

5. Do REP 3.1.2 Punch Module Installation.

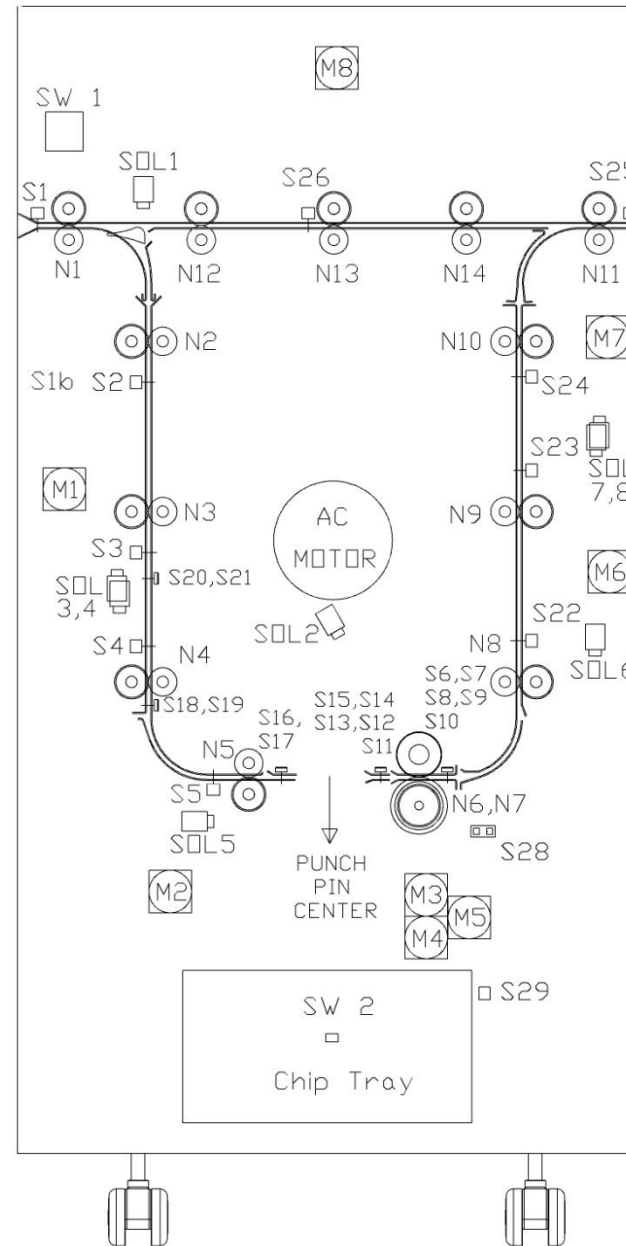

GP 6.16 Panel Latch Inspection

Magnetic latches on the Entrance and Exit Idler Panels, and the Upper Bypass Idler Assembly hold the Idler Panels in place, which in turn keep even pressure on the idler rollers.

The latch for the Acceleration Idler Panel ensures the Acceleration Panel remains firmly closed to keep even pressure on the Acceleration Idler Roller.

Maintenance Schedule

Inspect every 1,000K cycles.

Entrance Idler Panel Latch, Exit Idler Panel Latch, Upper Bypass Panel Latch Inspection

To inspect these three latches follow the procedure below:

- Entrance Idler Panel Latch
 - Exit Idler Panel Latch
 - Upper Bypass Panel Latch
1. Open the Front door.
 2. When the idler panel is latched, the idler panel spacers ((2) spacers for each Idler assembly) should contact the drive panels completely. There should not be any movement in the idler assembly (toward or away from the drive panel).



3. When the idler panel is opened and closed, you should be able to see the Idler springs extend, which will ensure proper idler roller pressure.



4. To adjust the Idler Panel magnetic Latches, do ADJ 1.7 Idler Panel Magnetic Latches Adjustment.

Acceleration Idler Latch Inspection

To inspect the Acceleration Idler latch follow the below procedure:

1. Open the Front door.
2. Undock FuturoPunch Pro.
3. When the Acceleration panel latch is fully engaged, the tabs in the Idler panel should contact the drive panel. Inspect this for the latches in the front side and rear side.

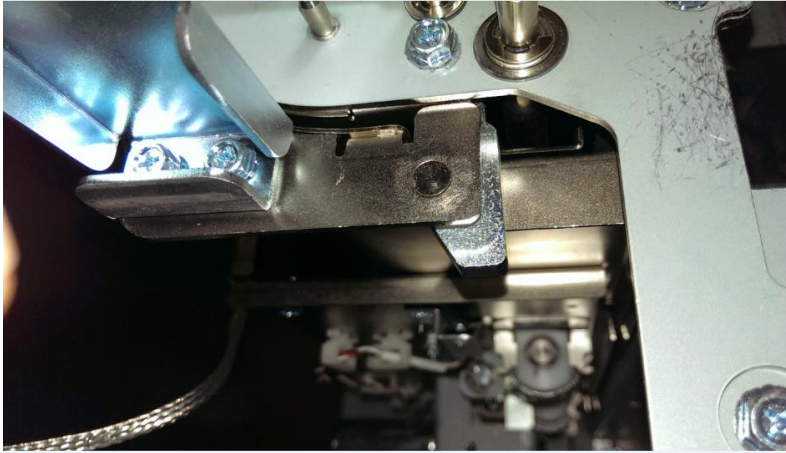

4. Do REP 3.1.1 Punch Module Removal to remove the Punch Module.
5. Inspect the Acceleration Idler Panel latch assembly (front and rear side). There should be two springs between the latch mechanism and the Entrance Drive panel.



Acceleration Panel Latch Springs

6. If the Springs are damaged, do REP 2.17 *Accel Idler Panel Rear Latch Assembly Replacement* or REP 2.17 *Accel Idler Panel Front Latch Assembly Replacement*.

7. When the idler panel is opened and closed, you should be able to see the Idler springs extend, which will ensure proper idler roller pressure.

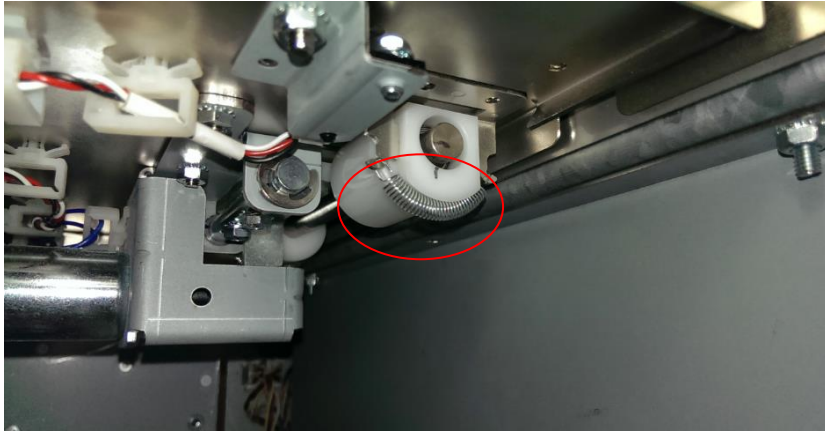

8. To adjust the Acceleration Idler Panel Latch, do ADJ 1.8.1 Entrance Drive Panel Position Adjustment.

GP 6.17 Optical Sensor Cleaning

Do the following to inspect and clean the Optical Sensors.

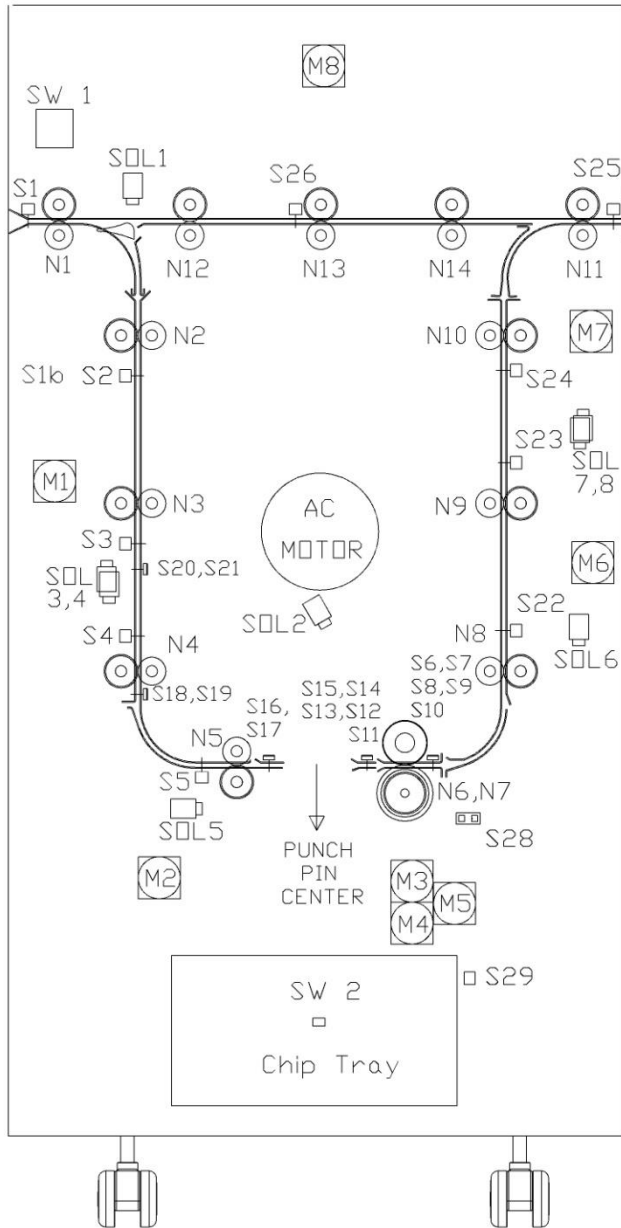

Maintenance Schedule

Inspect and clean every 500K cycles.

Procedure

Inspect and clean per the maintenance schedule or as needed.

Supplies Needed

For paper path sensors S1–S5, S22–S26 use canned air or a clean cloth and alcohol.

For edge detection sensors S6-S21 use an anti-static, pre-moistened lens cleaning wipe (non- alcohol based) for cleaning the LED (see parts list) and canned air for the sensor slot.

Cleaning

For paper path sensors use canned air or a clean cloth with alcohol to remove the debris off each sensor eye.

For edge detection sensors use the folder corner of the wipe to clean the lens of the LED's as shown. Wipe the LED lenses until the dust/debris is completely removed. Use canned air to remove dust/debris from the slot between the 2 LED's.

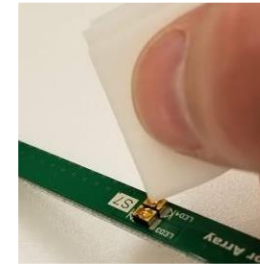

For sensor locations, refer to:

- PL 4.1
- PL 4.2
- PL 4.3
- PL 4.4
- PL 4.5
- PL 5.4
- PL 5.7
- PL 3.5

GP 6.18 Bypass Paper Path Inspection and Cleaning

Do the following to inspect and clean the Bypass Paper Path every 1000K cycles.

1. Inspect the Bypass panel, rollers, and entrance guide for wear, damage, and obstructions.
2. Inspect the rollers for wear patterns or grooves. The surface should be rough and even. Make sure the rollers are clean. Clean rollers with a soft cloth and alcohol.
See also *GP 6.14 Idler Roller and Idler Springs* Inspection (page 6-60) and *GP 6.15 Drive Roller and Steering Drive Roller* Inspection and Cleaning (on page 6-63).
3. Raise the panel and ensure the magnet holds it in open [4]. Inspect the path for obstructions. Clean as needed.
4. Close the panel and check that it is flat and that paper will pass under it.
5. Ensure the bypass diverter moves freely and returns to the bypass position.



GP 6.19 Punch Paper Path Inspection and Cleaning

Do the following to inspect and clean the Punch Paper Path every 1000K cycles.

1. Inspect the entire paper path through the punch. Look for wear, damage, and obstructions.
2. Inspect the rollers for wear patterns or groves.
3. Open the Entrance Idler Panel, Acceleration Roller Idler, and Exit Idler Panel and make sure there are no obstructions.
4. Confirm that the Entrance Idler Panel Latch, Acceleration Roller Idler Latch, and Exit Idler Panel Latch hold the panels tightly in place.
If the latch is bent or damaged, replace the Entrance Idler Panel (REP 2.2), Acceleration Roller Idler Assembly (REP 2.3), or the Exit Idler Panel (REP 2.6).
5. Clean as needed.

GP 6.20 Punch Drive Cam Lubrication

Do the following to lubricate the Punch Drive Cam.

Maintenance Schedule

Lubricate every 5000K cycles with Teflon grease.

Procedure

1. Do REP 1.6 Rear Cover Replacement to remove the Rear Cover.
2. Do REP 3.1 Punch Module Replacement to remove the Punch Module.
3. Clean the old grease from the cams and then apply a light coat of high quality grease (not oil).

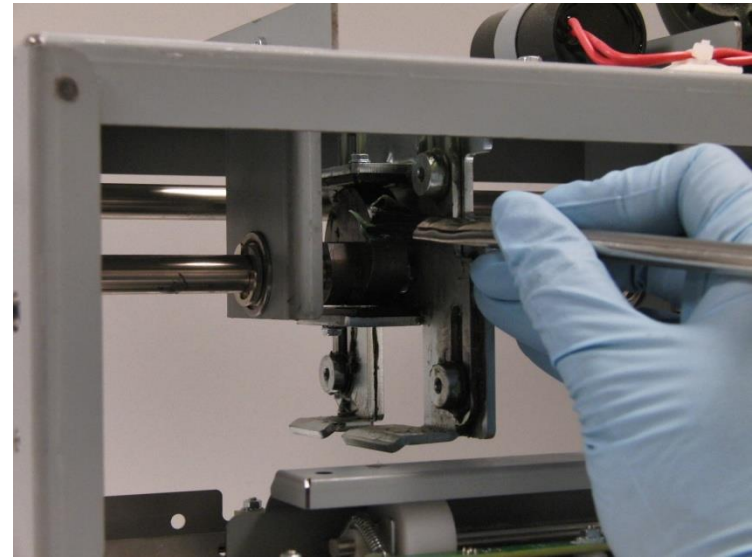
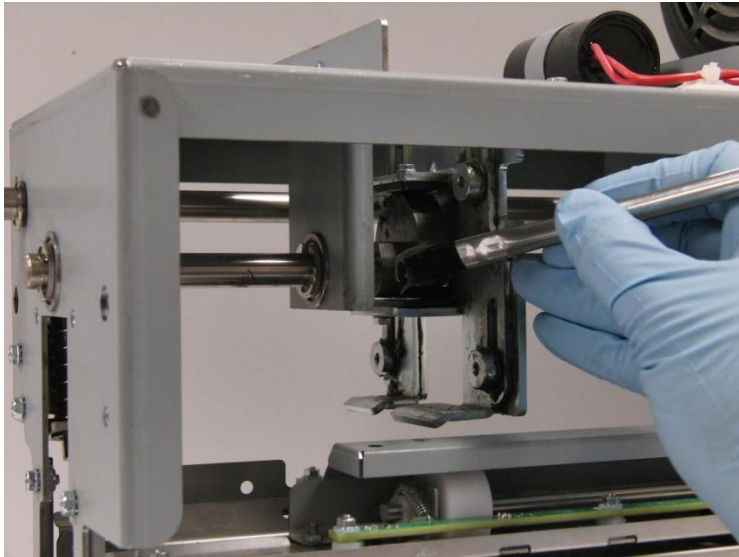

4. Do REP 3.1 Punch Module Replacement to install the Punch Module.
5. Do REP 1.6 Rear Cover Replacement to install the Rear Cover.

GP 6.21 Timing Belt Inspection

There are 11 belts used in the FuturoPunch Pro.

Assembly	# of Belts
Punch Module	1 belt
Steering Module	1 belt
Drive Panel Steering Sub Assembly	2 belts
Frame	8 belts

Five of the belts at the rear of the Frame have Tensioner Assemblies. It is these five belts that should be checked.

Maintenance Schedule

Inspect the Timing Belt every 1000K cycles.

Procedure

Do the following to inspect the Timing Belts.

1. Inspect all timing belts for wear, missing teeth, frayed edges, and cracks.
2. For replacement, see *REP 2.21 Timing Belt Replacement*
3. Check for proper deflection of belts.
The belts should be slightly loose with approximately 1/4" deflection [1].
Belts that are too loose will not drive properly and belts that are too tight can wear out prematurely or damage their driven components.

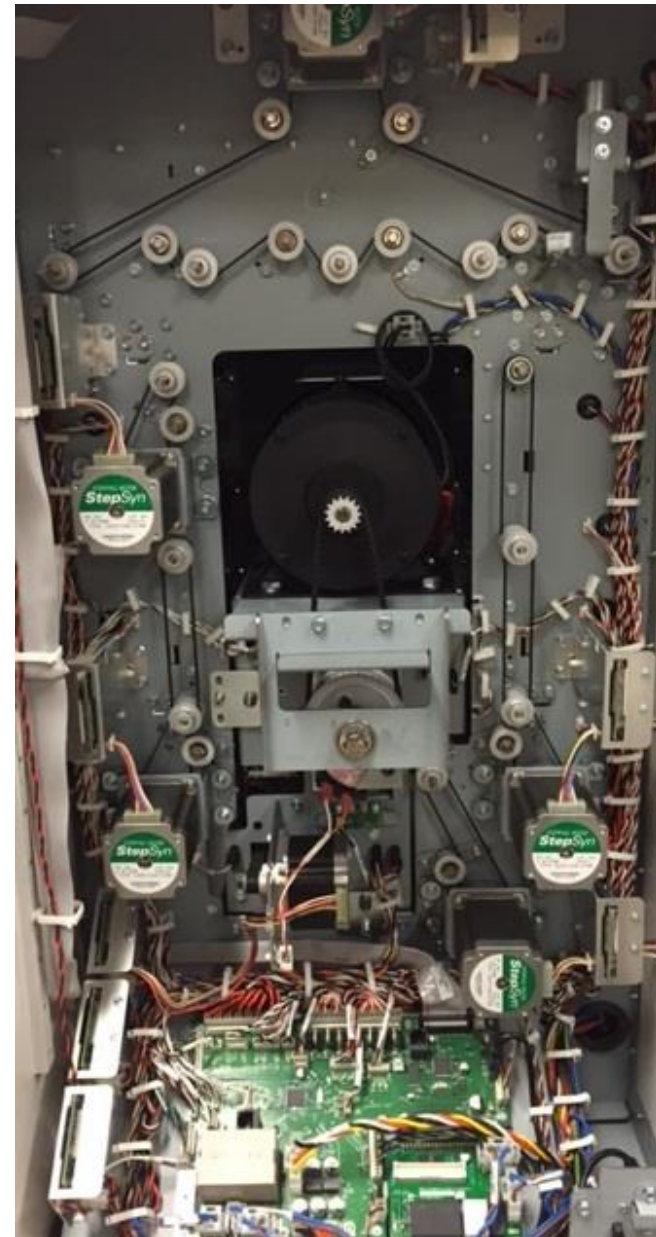

GP 6.22 Solenoid Cleaning and Inspection

Do the following to inspect and clean the Solenoids every 1000K cycles.

1. Open the front the door and insert an Interlock Cheater into the Punch Door interlock Switch SW4 (PL 2.2).

WARNING

Moving Parts, keep hands clear of nips and the belts when the Interlock Cheater is inserted. See Section 0, page vii for other languages.

2. Do GP 6.2.10 SOLENOIDS Procedure to activate and deactivate the affected solenoid.

When the solenoid is not activated, the idler roller should be able to rotate freely and in turn will drive the drive roller.



not activated



fully activated

When the solenoid is fully activated, the idler roller should completely lift off and not be able to drive the drive roller.

NOTE: Disengaging solenoid modules need to be replaced every 5 million cycles.

3. Clean the solenoid and surrounding area with a vacuum cleaner and canned air.

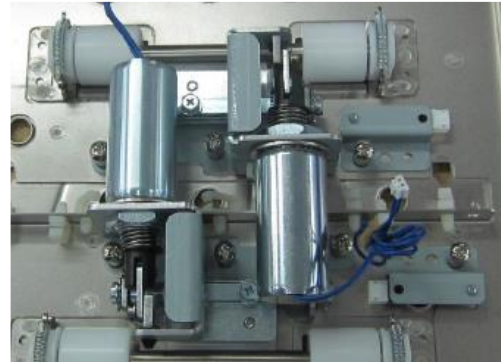

1. Make sure the solenoid is clean and dry.
2. Inspect for dirt or obstructions, wear or a damage spring.
3. Inspect and ensure the Solenoid linkage moves freely. Press linkage down and release. Linkage should return.

Note: Do not apply lubricants to the solenoid or linkage.

GP 6.23 Alignment Carriage Rails Cleaning

Do this procedure to clean the Alignment Carriage Rails.

Preventative Maintenance:

Do this every 500K cycles.

Procedure

1. Do REP 3.1.1 to remove the Punch Module
2. Use a can of compressed air to remove dust from the alignment carriage rails. The carriage can be moved back and forth on the rails to clean the entire surface. Alternately, a soft cloth and alcohol can be used.

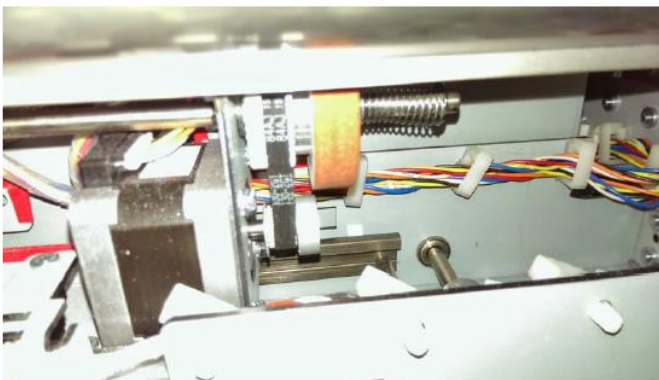
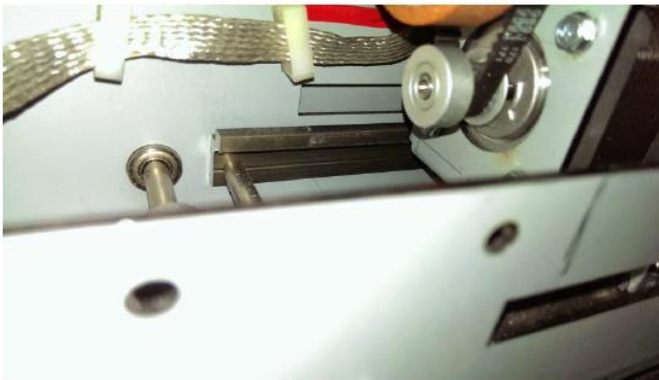

3. Once the rails are cleaned, check the motion of Alignment carriage (PL 5.3) on the rails. It should move when a force less than 2kgf is applied. If there is binding in the rails, replace the Alignment Carriage sub-assembly.
4. Do REP 3.1.2 to install the Punch Module.

Important Note: DO NOT use any lubricant on the rail.

GP 6.24 Punch Clutch Inspection and Cleaning

Use this procedure to inspect and clean the punch clutch every 1000K cycles.

1. Press the Power Switch to the off position.
2. Disconnect the Power Cord.
3. Do REP 1.6 to remove the Rear Cover.
4. With a cloth wipe the collar of the clutch and remove any oil from the surface.

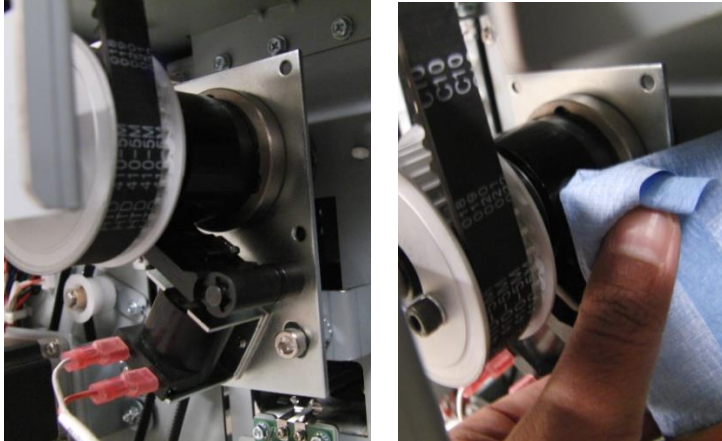

5. Inspect the collar stop and the metal insert pawl for any wear.



6. Check the tightness of (2) cone point set screws in the clutch.
7. Inspect the tightness of the M6 lock nut and M6 socket head cap screw.



8. Check the indexing of the Punch cam, ADJ 1.5 Punch Cam Indexing.
9. If necessary, do REP 3.1.2 Punch Module Installation.
10. Do REP 1.6 to install the Rear Cover,
11. Connect the Power Cord.
12. Press the Power Switch to the ON position.
13. Do GP 6.2.12 FUNCTION TESTS Procedure (Cycle Punch, Aligner Test, Fan Test).

GP 6.25 Diverter Solenoid Assembly Inspection

Use this procedure to inspect the Diverter Solenoid Assembly every 1000K cycles.

1. Press the Power Switch to the off position.
2. Disconnect the Power Cord.
3. Do REP 1.6 to remove the Rear Cover.
4. Clean the Solenoid and surrounding area with a vacuum cleaner and canned air.
5. Make sure the solenoid is clean and dry.
6. Raise the Diverter Solenoid by hand and release it. The Diverter should fall freely. Make sure the linkage operates smoothly.



7. Open the front door and insert an Interlock Cheater into the Punch Door Interlock switch SW4 (PL2.2).
8. Press the Power Switch to the on position.

Warning

Moving Parts, keep hands clear of nips and the belts when the Interlock is cheater is inserted. See Section 0, page vii for other languages.

9. Do GP 6.2.10 Solenoids Procedure to activate and deactivate Solenoid SOL1.

The diverter gate should rise and fall when SOL1 is cycled.

GP 6.26 Die Set Recognition Board Clips Inspection

Use this procedure to Inspect and clean the Die Set recognition board clips every 1000K cycles.

1. Press the Power Switch to the off position.
2. Disconnect the Power Cord.
3. Do REP 1.6 to remove the Rear Cover.
4. Inspect the Die Set Recognition reader spring clips to check if they are bent. When a die set is inserted, the spring clips should deform and fully contact the Die Set Recognition Board in the Die Set .



5. Wipe the spring clips with a clean cloth.
6. Do ADJ 1.6 if necessary.

GP 6.27 Die Lock Mechanism and Die Rail Springs Inspection

Use this procedure to inspect the Die lock mechanism every 1000K cycles

1. Press the Power Switch to the off position.
2. Disconnect the Power Cord.
3. Do REP 1.6 to remove the Rear Cover.
4. Do REP 3.1.1 to remove the Punch Module.
5. Raise the die lock plunger by hand to inspect if there is a heavy spring force. There is an internal spring in the mechanism that provides the locking load. The load is quite heavy and the plunger may not move up. This is normal and can be verified again during Step 10.



6. Inspect (4) plastic bushings in the Die lock brackets. (2) in the front and (2) in the back.



7. Inspect the surface of the cam and cam follower pad, if there is any debris, clear it.
8. Inspect the (2) external compression springs.
9. Inspect the Die rail springs. The tip of the springs should be in contact with the side face of the die rail.

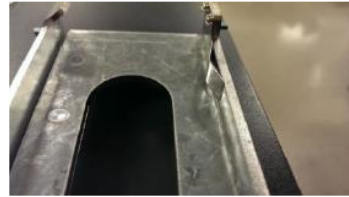

Good Spring

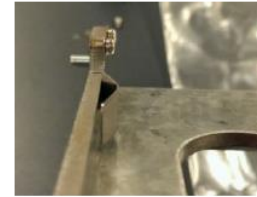

Deformed Spring

10. Insert a Die set in the die rail and lock the Die set and check if the tip contacts the die set base plate only. The Die lock mechanism should not contact anywhere else.
11. The Die Set should also slide in easily deforming the Die rail springs.



General Information

Principle of Operation

The GBC FuturoPunch Pro is a machine that punches various die set hole patterns into single sheets of paper. The machine is placed between a printer or copier and a finisher. The punch has two paper paths.

- The punch path.
- The bypass section.

Punch Path

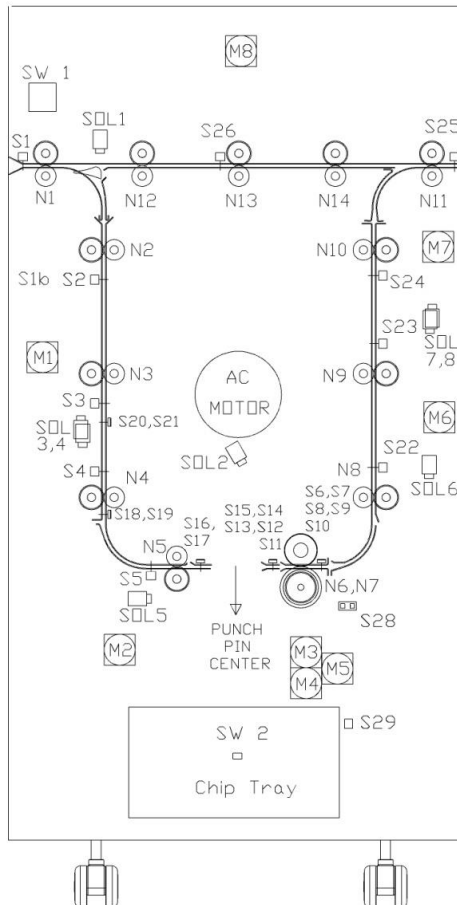

If the Punch is enabled, the transport and punch motors are started, and the Divert Solenoid SOL 1 is activated to direct the sheets into the punch path.

There are two modes of operation Single Punch and Double Punch.

Single Punch

The sheet enters the Punch at roller N1 running at printer line speed.

When the lead edge of the sheet reaches Sensor S5 (plus a delay to ensure the sheet is in roller N5) the sheet is accelerated to system speed of 1300mm/s.

The sheet enters the steering rollers N6 & N7 and the angle of the sheet is measured by Sensors S6-S10 and is then de-skewed by rollers N6 & N7.

After deskew, the front edge of the sheet is moved to alignment sensor S11-S15.

The sheet is transported by N6 & N7 until the trail edge is close to the Backgauge Sensors S16 & S17.

The sheet is slowed and moves until the trail edge is detected at Sensors S16 & S17, at which point it moves a further set number of steps (backgauge) and stops.

The sheet is punched on the trail edge.

Once the punch cycle is complete the sheet is accelerated by N6 & N7 to the system line speed.

Once the lead edge hits S24 (plus a delay to ensure the sheet is in roller N10) the sheet is decelerated to the printer line speed.

Double Punch (Mid punch + trail edge punch)- DFA configurations only

The sheet enters at roller N1 running at printer line speed.

When the lead edge of the sheet reaches S5 (plus a delay to ensure the sheet is in roller N5) the sheet is accelerated to system speed of 1300mm/s.

The sheet enters the steering rollers N6 & N7 and the angle of the sheet is measured by S6-S10 and then deskewed by rollers N6 & N7.

After deskew the front edge of the sheet is moved to alignment sensor S11-S15.

The sheet is transported by N6 & N7 until the trail edge is close to the Backgauge Sensors S18 & S19 for SEF A4/SEF LTR and S19 & S20 for SEF A3/11x17.

The sheet is slowed and moves until the trail edge is detected at sensors S18 & S19 for SEF A4/SEF LTR and S19 & S20 for SEF A3/11x17, at which point it moves a further set number of steps (backgauge) and stops.

The sheet is mid-punched.

Once the punch cycle is complete the sheet is accelerated by N6 & N7 to the system line speed.

The front edge of the sheet is moved to Alignment Sensors S11-S15.

When the trail edge is close to the Backgauge Sensors S16 & S17 the sheet is slowed and moves until the trail edge is detected at S16 & S17, at which point it moves a further set number of steps (backgauge) and stops.

The sheet is punched on the trail edge.

Once the punch cycle is complete the sheet is accelerated by N6 & N7 to the system line speed.

Once the lead edge hits S24 (plus a delay to ensure the sheet is in roller N10) the sheet is decelerated to the printer line speed.

Bypass Path

If the Punch is not enabled, the FuturoPunch will run in bypass mode (no punching).

The sheet enters the Punch at roller N1 running at printer line speed.

The Divert Solenoid SOL 1 is not activated, so the sheets are directed into the bypass path.

When the lead edge of the sheet reaches nip 13, the sheet is detected by Bypass Sensor S26,

The sheet is transported by N12, N13, N14, and N11 until the trail edge of the sheet reaches Exit Sensor S26.

Refer to the electrical wiring information and to Parts List *PL 3.7, Frame Assembly (page 7 of 10) Sensors*, when reading the following material on Inputs and Output signals.

Table 6.1 Input Devices

Input	Type	Function
Sensor S1	Optical	Entrance Sensor
Sensor S2	Optical	Entrance Idler Panel Sensor
Sensor S3	Optical	Entrance Idler Panel Sensor
Sensor S4	Optical	Entrance Idler Panel Sensor
Sensor S5	Optical	Accel Sensor
Sensor S6	Circuit Board	Skew Board Sensor
Sensor S7	Circuit Board	Skew Board Sensor
Sensor S8	Circuit Board	Skew Board Sensor
Sensor S9	Circuit Board	Skew Board Sensor
Sensor S10	Circuit Board	Skew Board Sensor
Sensor S11	Circuit Board	Alignment Sensor
Sensor S12	Circuit Board	Alignment Sensor
Sensor S13	Circuit Board	Alignment Sensor
Sensor S14	Circuit Board	Alignment Sensor
Sensor S15	Circuit Board	Alignment Sensor
Sensor S16	Circuit Board	Backgage Sensor
Sensor S17	Circuit Board	Backgage Sensor
Sensor S18	Circuit Board	Large Mid Punch Backgage Sensor
Sensor S19	Circuit Board	Large Mid Punch Backgage Sensor
Sensor S20	Circuit Board	XL Mid Punch Backgage Sensor
Sensor S21	Circuit Board	XL Mid Punch Backgage Sensor
Sensor S22	Optical	Exit Idler Panel Sensor
Sensor S23	Optical	Exit Idler Panel Sensor
Sensor S24	Optical	Exit Idler Panel Sensor
Sensor S25	Optical	Exit Sensor

Sensor S26	Optical	Bypass Sensor
------------	---------	---------------

Input	Type	Function
Sensor S27	Sensor, Vein Sharp	Bypass Open Sensor
Sensor S28	Optical	Align Home Sensor
Sensor S29	Emitter Receiver	Chip Tray Full Emitter/Receiver
Solenoid SOL1	Mechanical	Divert Solenoid
Solenoid SOL2	Mechanical	Punch Clutch Solenoid
Solenoid SOL3	Mechanical	Entrance Idler Solenoid
Solenoid SOL4	Mechanical	Entrance Idler Solenoid
Solenoid SOL5	Mechanical	Accel Idler Solenoid
Solenoid SOL6	Mechanical	Exit Idler Solenoid
Solenoid SOL7	Mechanical	
Solenoid SOL8	Mechanical	
Switch SW1	Mechanical	Punch Door Interlock Switch, no machine movement if door is open
Switch SW	Mechanical	Chip Tray Home Switch

Glossary of Terms

These terms are common to the punch and bindery industry.

Alignment	A predetermined distance of the top punched hole from the side edge of the sheet (viewed from the punch output orientation).
Backgauge	A predetermine distance from the trail edge of the sheet of paper to the punched hole(s). For double-punch, a predetermined distance from the center of the sheet of paper to the mid-punched hole (s)
Deskew	The term used to describe the process of aligning the sheet of paper until it is parallel to the paper path.
Skew	The term used to describe the fact that the sheet of paper is not parallel to the paper path.

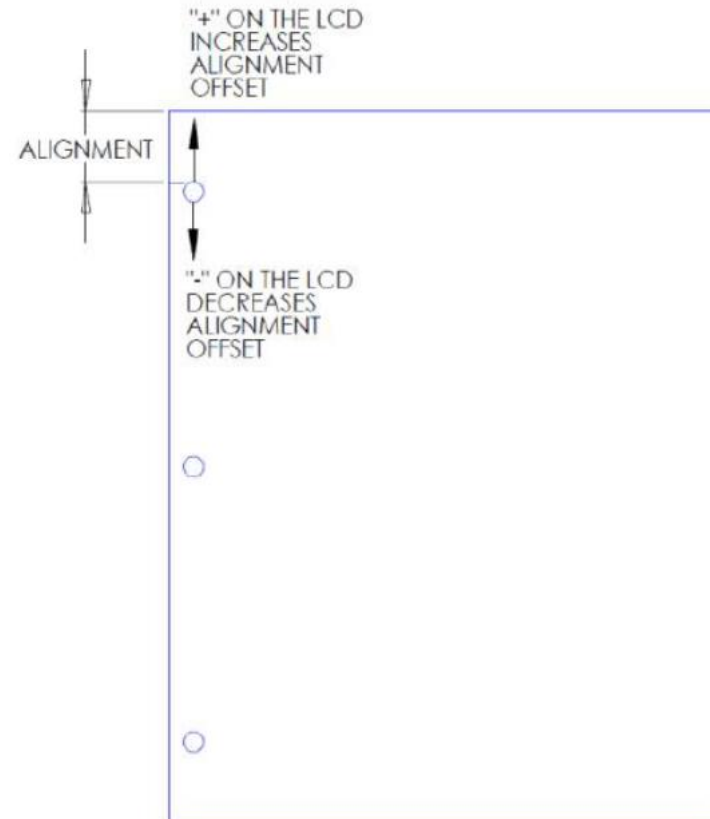
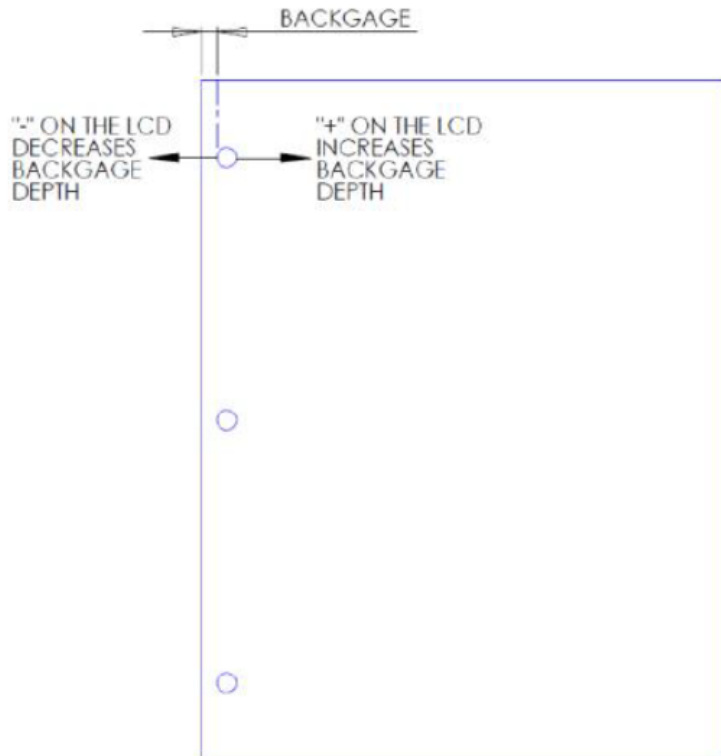

Die Sets

The FuturoPunch Pro uses a variety of easily interchangeable die sets that allow you to punch documents in line for several different binding styles.

Please note that each punching style listed below requires a separate die set for the FuturoPunch Pro. The FuturoPunch Pro can hold up to four Die Sets in its cabinet (one in the operating slot and three in the storage area).

Die Sets will decrease in performance over time based on the types of stocks and weights that are being punched.

The expected life of a die set is 750K punches when punching 20 lb bond (75 gsm paper).

Die Sets should be regarded as a long-term supply item.

To purchase additional or replacement Die Sets, contact your authorized sales representative.



Die Sets List

By selecting the appropriate die set, you can use your FuturoPunch Pro to punch documents in any of the binding styles indicated in the tables below.

For Plastic Comb Binding:

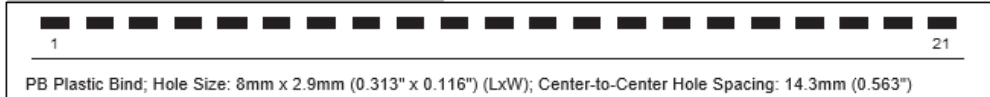

For Twin Loop™ Binding:

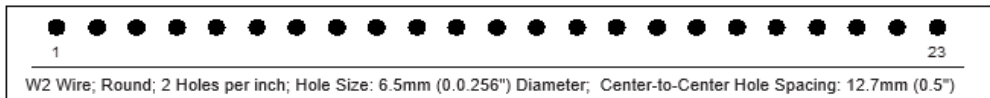
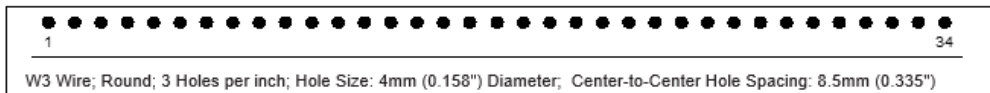
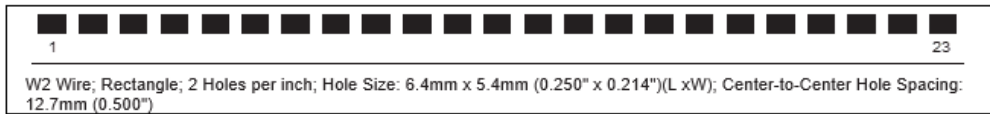
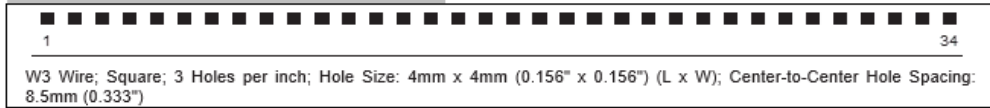

For Color Coil™ Binding:

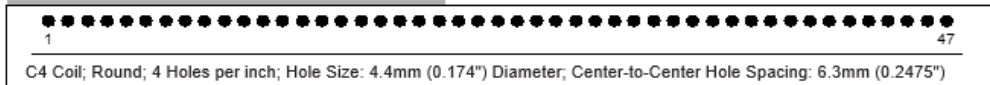

For Loose Leaf Binding:

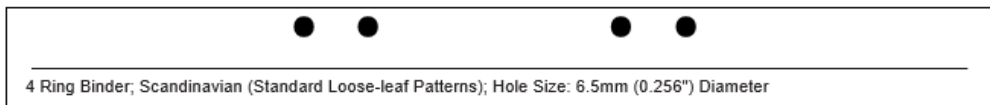
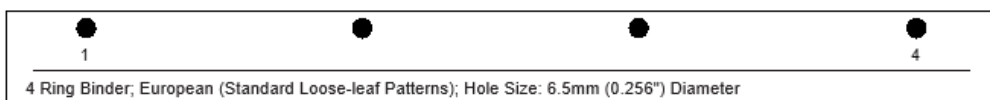
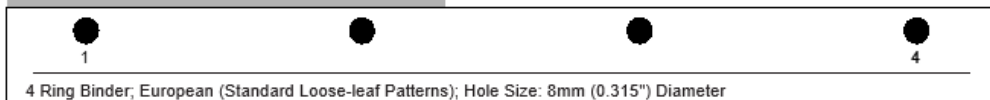

Die, Fujifilm, Comb Bind	CWAA1100
--------------------------	----------

Die, Fujifilm, Wire 3.1, Sq.	CWAA1105
------------------------------	----------

Die, Fujifilm, Wire 2.1, Sq.	CWAA1104
------------------------------	----------

Die, Fujifilm, Wire, 3:1, Rnd.	CWAA1103
--------------------------------	----------

Die, Fujifilm, Wire, 2:1, Rnd.	CWAA1102
--------------------------------	----------

Die, Fujifilm, Coil, Rnd.	CWAA1101
---------------------------	----------

Die, Fujifilm, 4 Hole, 8mm	CWAA1106
----------------------------	----------

Die, Fujifilm, 4 Hole, 6.5mm	CWAA1109
------------------------------	----------

Die, Fujifilm, 4 Hole, Scan	CWAA1110
-----------------------------	----------

Die Sets List (cont'd)

By selecting the appropriate die set, you can use your FuturoPunch Pro to punch documents in any of the binding styles indicated in the tables below.

For Velo® Bind:



1 12

VB Velobind®; Round; 1 Hole per inch Hole Size: 3.2mm (0.126") Diameter; Center-to-Center Hole Spacing: 25.4mm (1")

Die, Fujifilm, Velobind®, 12 Holes, A4.	CWAA1111
---	----------

For Loose Leaf Binding:



1 3

3 Ring Binder; U.S. (Standard Loose-leaf Patterns); Hole Size: 8mm (0.316") Diameter

Die, Fujifilm, 3 Hole, 8mm	CWAA1107
----------------------------	----------



1 7

3 Ring, 5 Ring, 7 Ring; U.S. (Standard Loose-leaf Patterns); Hole Size: 8mm (0.316") Diameter

Die, Fujifilm, 3/5/7 Hole, 8mm	CWAA1108
--------------------------------	----------

©2014 GBC, Lake Zurich, Illinois - All rights reserved.

Graphics do not represent actual punch pattern dimensions or spacing.

Tools

Tools recommended for service of the GBC FuturoPunch Pro:

Standard Tools (metric)

- 7mm Nut Driver
- 5.5mm Nut Driver
- 7mm Open End Wrench
- 5.5mm Open End Wrench
- Needle Nose Pliers
- Phillips Screwdriver
- Flathead Screwdriver
- Wire Cutters
- Metric Allen Key Set (1.5mm, 2mm, 2.5mm, 3mm, 4mm, 5mm)

Other Recommended Tools and Supplies

- 0.25mm, 1mm, and 3mm Shim Gauges
- 0 to 2 kgf Force gage
- Loctite
- 10mm Open End wrench
- 6mm Allen Key
- 150mm Metric ruler

Lubrication

For General lubrication please see the following sections

- GP 6.7.3, Die Set Lubrication
- GP 6.20, Punch Drive Cam Lubrication

Cleaning Materials

Use a clean, soft, lint-free cloth or a small paint brush to clean the following.

- GP 6.8, External Cleaning
- GP 6.9, Internal Cleaning

Use a soft cloth and alcohol to clean the following.

- GP 6.14, Idler Roller Inspection and Cleaning
- GP 6.15, Drive Roller Inspection and Cleaning

Use canned air or soft cloth to clean the following.

- GP 6.17, Optical Sensor Cleaning
- GP 6.26, Alignment Carriage Rails

Use canned air or vacuum cleaner to clean the following.

- GP 6.22, Solenoid Cleaning and Inspection

Serial Numbers

The GBC FuturoPunch Pro Serial Number is located inside the Front Door on the front frame just below the Bypass Section.

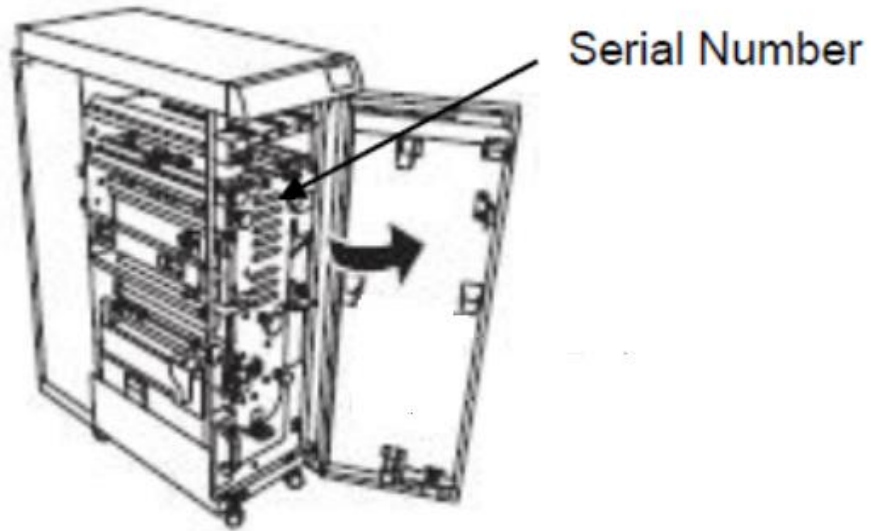

This page intentionally left blank.

Notes:

Section Contents

Wiring Data

Title	Page
System Wiring	7-3
Plug Jack Connectors	7-4

This page intentionally left blank.

System Wiring

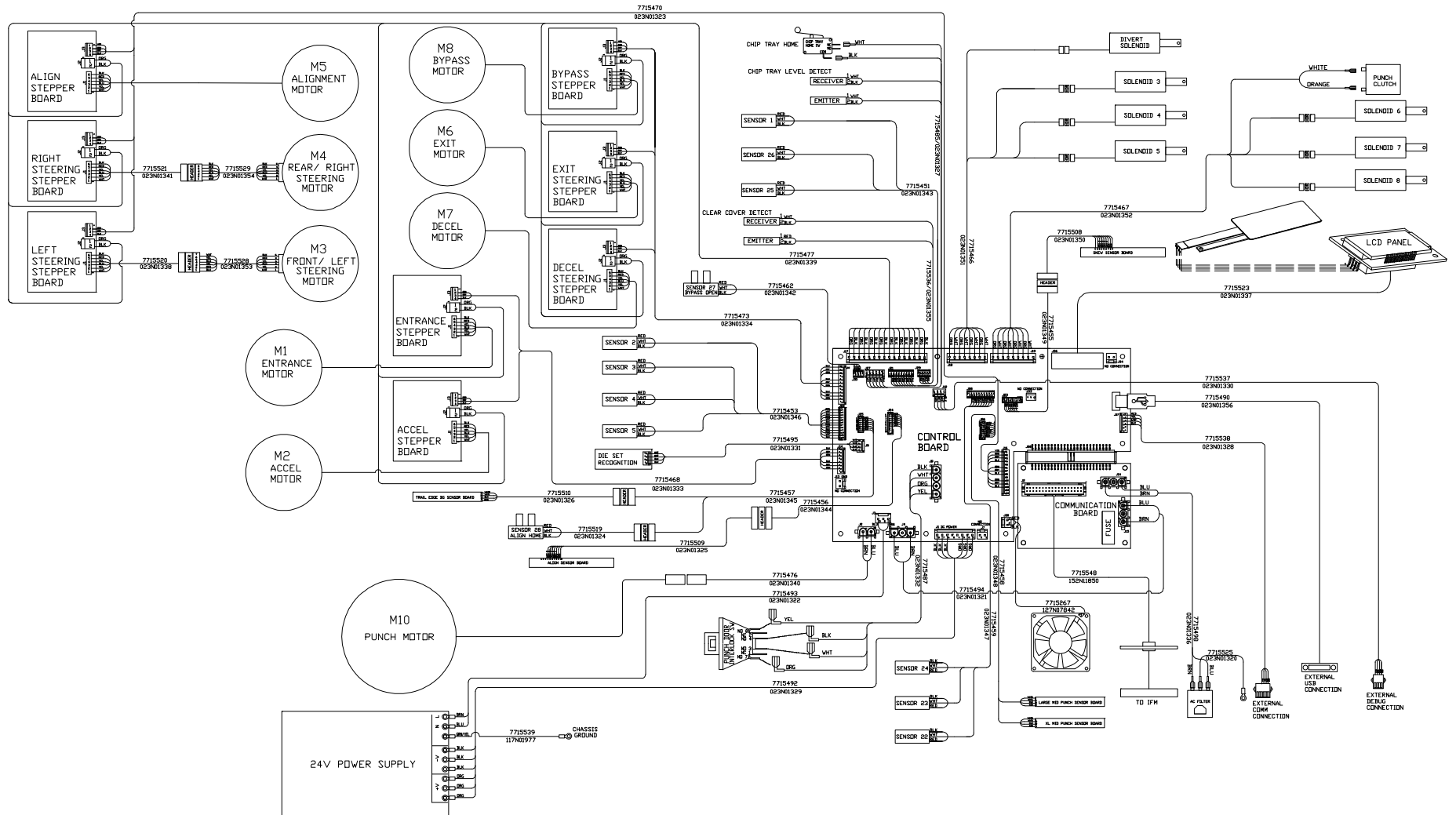

Plug Jack Connectors

